

STAR WARS

ROLEPLAYING GAME



EQUIPMENT STATS

THIAGO S. ARANHA

STAR
WARS

STAR WARS

EQUIPMENT STATS

by Thiago S. Aranha

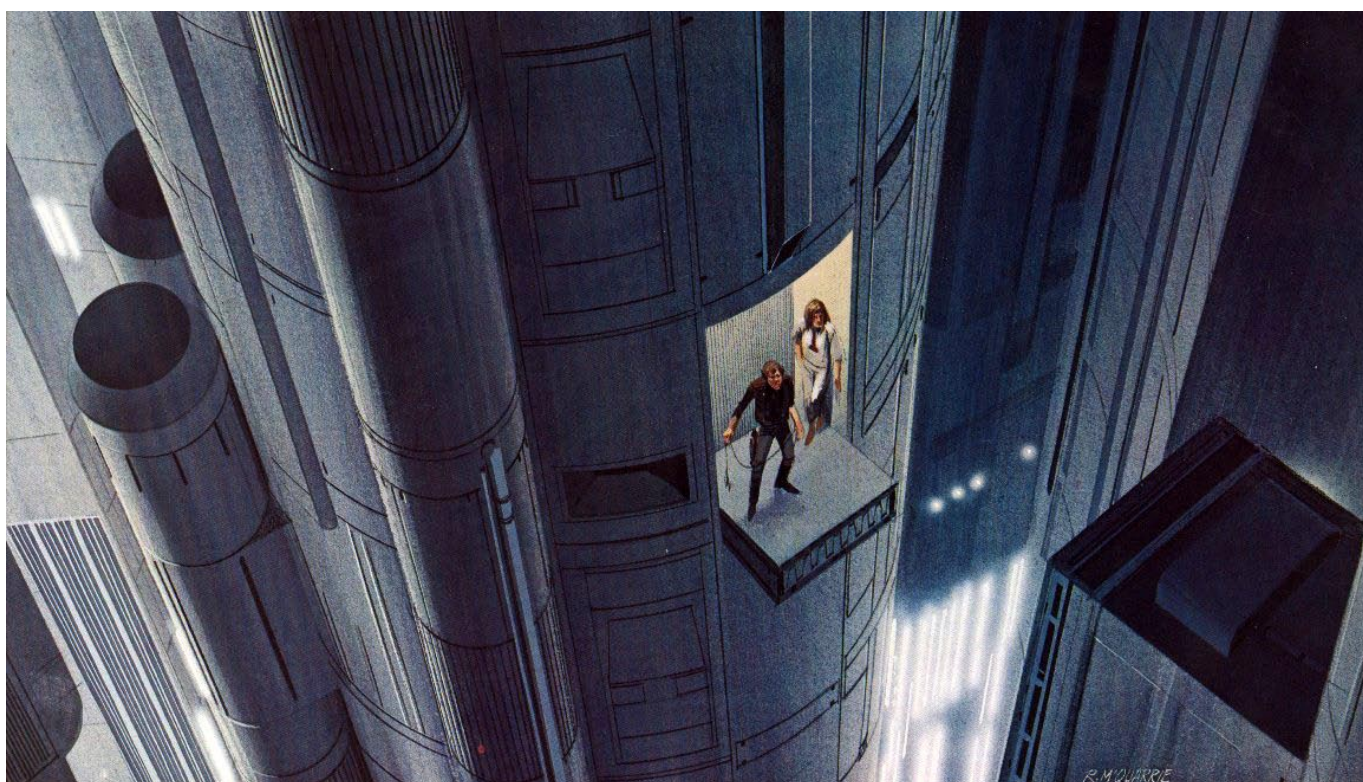

Adventure Journal stats by Grimace

Table of Contents

Protective Gear

Protective Vests

- 05. Leather Jerkin
- 05. Tracker Utility Vest
- 05. CV14-B Concussion Vest
- 05. Blast Vest
- 05. Koromondain Half-Vest
- 06. Corondexx Blast Vest
- 06. Barabel Microbe Armor
- 06. Massassi Chest Shield

Armor Accessories

- 06. Rock Boots
- 06. CT3 Concussion Helmet
- 06. Blast Helmet
- 06. Sonic Dampening Helmet

Camouflage Armor

- 07. Umbaran Shadowcloak
- 07. Camouflage Poncho
- 07. Camouflage Fatigue
- 07. Shadowsuit
- 07. Camo Armor
- 07. Thermoguard Jumpsuit

Environmental Suits

- 08. Shipsuit
- 08. Body Glove
- 08. All-Temperature Cloak
- 08. Morseerian Environmental Suit
- 08. Thinsuit
- 09. Oogolith Cloaker
- 09. Lightweight Armor
- 09. Light Scout Armor
- 09. Scout Armor
- 10. A-5 Envirosuit
- 10. SeaScape Diving Suit
- 10. Skakoan Pressure Suit
- 11. Versatex Survival Suit
- 11. Polarizing Field Insulator Suit

Spacesuits

- 11. Vacuum Oogolith
- 11. Vacuum Suit
- 11. Tech Vacuum Suit
- 11. LifeLine Space Suit
- 12. Flight Suit
- 12. Padded Flight Suit
- 12. Armored Flight Suit
- 12. Flitter Vacuum Suit
- 12. Vagabond Suit
- 13. Bulk Exploratory Armor
- 13. Space Suit
- 13. Armored Vacuum Suit
- 13. Wrokix Works Armored Spacesuit
- 14. Merr-Sonn Armored Spacesuit
- 14. Heavy Radiation Powersuit

- 14. Nova-Tech Powersuit
- 15. EVA Vacuum Pod

Combat Armor

- 15. Primitive Armor
- 15. Shockball Uniform
- 15. Twi'lek Antistun Suit
- 16. Reflect Body Glove
- 16. Combat Jumpsuit
- 16. Link Armor
- 16. Glistaweb
- 16. Blast-Dampening Armor
- 17. Flex-Armor
- 17. Castaan Staad Armor
- 17. Electromesh Armor
- 17. Corellian 611 Combat Armor
- 17. Arelik Armor
- 17. Fenelar Armor
- 17. Cresh Luck Armor
- 17. Ubese Raider Armor
- 18. Gladiator Armor
- 18. Dura-Armor
- 18. Coynite Battle Armor
- 18. Stalker Armor
- 19. M'uhk'gfa Battle Plate
- 19. A3AA Personal Defense Module
- 19. "Nullifier" Energy Diffusion Armor
- 19. Warrior's Armor
- 19. Subaltern's Armor
- 19. Subcommander's Armor
- 20. Commander's Armor
- 20. Supreme Commander's Armor
- 20. Warmaster's Armor
- 20. Dead Armor
- 20. Dark Combat Jumpsuit
- 20. Dark Padded Battle Armor
- 20. Dark Heavy Battle Armor
- 21. Orbalisk Armor

Powersuits

- 21. Galax Systems Powersuit
- 21. Servo-Lifter
- 22. Bounty Hunter Armor
- 22. Smasher Armor
- 22. Corellian Powersuit
- 22. Corellian HuntSuit
- 22. Charon Battle Armor
- 23. AV-1S (Scout)
- 23. AV-1C (Combat)
- 24. AV-1A (Assault)
- 24. Telgorn Corp. Mark II Powersuit
- 24. Telgorn Corp. Mark III Powersuit
- 25. Telgorn Corp. Mark IV Powersuit
- 25. Telgorn Corp. Mark V Powersuit
- 25. Telgorn Corp. Mark VI Powersuit

- 25. Malgon Armor
- 25. Nemesis Armor
- 26. Krail 210 Personal Armor
- 26. Dragon Armor
- 27. Sunder 9
- 27. Hutt Battle Armor
- 27. Juggernaut Armor
- 28. Leviathan Armor

Military Unit Armor

- 29. Espo Armor
- 29. Espo Riot Armor
- 29. Jedi Battle Armor
- 30. Rodian Protector Armor
- 30. Iotran Braceman Armor
- 30. Gorothe Planetary Police Armor
- 31. Clone Trooper Armor, Mark I
- 31. Clone SCUBA Trooper Armor
- 31. ARC Trooper Armor
- 32. Katarn Armor
- 32. Clone Trooper Armor, Mark II
- 32. Royal Guard Armor
- 33. Coruscant Guard Armor
- 33. Imperial Sentinel Armor
- 33. Imperial Dungeoneer Armor
- 34. Imperial Sovereign Protector Armor
- 34. CompForce Trooper Armor
- 34. Imperial Field Armor
- 34. Imperial Gunner Armor
- 35. Stormtrooper Armor
- 35. Sandtrooper Armor
- 35. AT-AT Operator Armor
- 36. Imperial Pilot Flight Suit
- 36. Scout Trooper Armor
- 36. Snowtrooper Armor
- 37. Swamp Trooper Armor
- 37. Raptor Commando Armor
- 37. Storm Commando Armor
- 38. Radtrooper Armor
- 39. Seatrooper Armor
- 39. Spacetrooper Armor

Individual Armor

- 40. Beylyssa's Armor
- 40. Boba Fett's Battle Armor
- 40. Boushh's Armor
- 41. Darth Vader's Armor
- 41. Dej Vennor's Armor
- 41. Dengar's Blast Armor
- 42. Jango Fett's Battle Armor
- 42. Jodo Kast's Battle Armor
- 43. Mist's Bounty Hunter Armor
- 43. Stormtrooper X's Modified Stormtrooper Helmet

Shields

- 44. Dampener Aerosol
- 44. Shield Gauntlet
- 44. Primitive Shield
- 44. Beastwarden's Shield
- 44. Riot Shield

- 44. Magnaforce Security Shield
- 44. Personal Energy Shield
- 45. "Hardpoint" Heavy Weapons Armor
- 45. Portable Shield Generator
- 45. Gungan Portable Shield Generator
- 46. Base Shield Generator
- 46. WorldArmor 4 Shield Generator
- 46. DefenStar Nyalsan II Planetary Shield
- 47. MerrWeapons WorldArmor 9 Planetary Shield
- 47. Planetary Shield

Conveyances

Climbing Gear

- 48. Fibra-Rope
- 48. Kashyy Vine
- 48. Syntherope
- 48. Syntherope Dispenser
- 48. Gyro-Grappler
- 48. Line Master TLG
- 49. Verti-Go Line Thrower
- 49. Grappling Gun
- 49. Repulsorlift Grappling Gun
- 49. Climbing Boots and Gloves
- 49. Tree-Claw
- 50. Power Pitons
- 50. Adhesion Disc
- 50. Climbsuit

Repulsors

- 50. Iyra Gravity Belt
- 50. Cloud Jumper
- 50. Grav Boots
- 50. Aratech R82 Jump Boots
- 51. Repulsorlift Cart
- 51. Repulsorlift Baggage Cart
- 51. Flotation Lifter

Jet Packs

- 51. Leaper Jet Pack
- 51. Jumper Jet Pack
- 51. NJP-433 Jet Pack
- 52. Screamer Jumper Jet Pack
- 52. Swiftsure Jet Pack
- 52. Whisper Jet Pack
- 52. Z-6 Jet Pack
- 53. Hush-About Jet Pack
- 53. Flutter Pack

Rocket Packs

- 53. Zim Systems Rocket Pack
- 53. Whisper Jumper Jet Pack
- 53. DSP-5 Rocket Pack
- 54. PRP-100 Rocket Pack
- 54. RP1 Carrier Rocket Pack
- 54. HSS Thruster Pack

Animal Gear

- 54. Coiling Tack
- 54. Tranthebar Racing Harness
- 55. Live Organism Comfort Conveyor

Medical

- 56. Containment Box
- 56. Containment Booth

Healing

- 56. Plasma Protein Replicator
- 56. Paravacc
- 57. Enzymer
- 57. Vitapill
- 57. Nilar Field Cauterizer
- 57. Slick
- 57. Medpac
- 57. Medkit
- 57. FastFlesh Medpac
- 58. Spray Plasto-Cast
- 58. Med-Aid
- 58. Bacta Geltab
- 58. Trauma Kit
- 59. Customized Medical Backpack
- 59. Abyssin Grafting Patch
- 59. Med Unit
- 60. Bacta Tank

Stabilizing

- 60. Replar Splint
- 60. Sluissi Gravitic Pressure Bandage
- 61. Bacta Tray
- 61. Anti-Shock Blanket
- 61. Portable Survival Pod
- 61. Hyperbaric Medical Chamber
- 62. Celegian Life-Support Chamber

Medical Scanners

- 62. Med Diagnostic Scanner
- 62. Medscanner
- 62. Bioscan
- 62. Medisensor

Drugs

- 63. Signature Scent Synthesizer
- 63. Elixir of Infatuation
- 63. Orfite Scent Mask
- 63. Cyduct Chemical Booster
- 64. Ryll Spice
- 64. Andris White Spice
- 64. Carsunum Black Spice
- 64. Glitterstim Spice
- 64. Death Stick

Boosters

- 65. Emotion Suppressant
- 65. Orfite Power Harness
- 65. Servo Slippers
- 65. Grav Mill
- 65. Myostim Unit

Cybernetics

- 66. Replacement Prosthetics
- 66. Cybernetic Hand
- 66. Cybernetic Forearm
- 66. Cybernetic Arm
- 67. Cybernetic Knee
- 67. Cybernetic Leg
- 67. Cybernetic Legs Package
- 67. Skeletal Reinforcement
- 67. Cardio-Muscular Package
- 67. Response Improvement

Package

- 68. Hifold Sensory Package
- 68. Hi-Sense Enhanced Eyes
- 68. Cybernetic Eye
- 68. Motion Interface Package
- 69. Ultrasound Sight Enhancer
- 69. Tremor Sensor
- 69. Neimoidian Data Goggles
- 69. Cyborg Construct
- 70. Weapon Mount
- 70. Cybernetic Nexus Ring

Survival

- 71. Glow Rod
- 71. Luma Flare
- 71. Personal Strobe Locator
- 71. Anti-Insect Canister
- 71. Animal Excluder
- 72. Ration Concentrates
- 72. Dehydrated Food Pack
- 72. Water Purifier
- 72. Water Purifying Canteen
- 72. Micro Fusion Reactor
- 72. Energy Capacitor
- 72. Defel Heat Reducer
- 73. Heat Induction Staff
- 73. Portable Heater
- 73. Radiation Deflection Pin
- 73. Radiation Deflection Badge
- 73. Coolth Backpack
- 73. Survival Pack
- 74. Scout's Survival Pack
- 74. Coruscant Survival Kit
- 74. Jedi Utility Belt

Breathing Gear

- 75. Oxygen Extractor
- 75. Breather-1 Breath Mask
- 75. Roamer-6 Breath Mask
- 75. Oxidizer
- 75. Tasari Breath Mask
- 76. Tasari Oxygen Tank
- 76. Breath Mask
- 76. Emergency Life Support Module
- 76. Aquata Breather
- 76. Organic Gill
- 77. Gnullith
- 77. Lungworm
- 77. Kel Dor Antiox Breath Mask

Shelters

- 77. Shelter
- 77. ThinHut
- 78. Bubble Cloak
- 78. Emergency Inflation Shelter
- 78. Pressure Tent
- 78. Aqua Survival Shelter

Communications

Communicators

- 79. Gnullith-Villip
- 79. Husher Mike
- 79. Implant Communicator
- 79. PTP Link
- 80. Personal Comlink
- 80. C1 Personal Comlink
- 80. MultiNode Comlink
- 80. 3-Mal Personal Comlink
- 80. Hush-98 Comlink
- 80. Wrist Chronometer
- 80. Headset Comlink
- 80. Military-Grade Comlink
- 81. Military Comlink

81. Secure-A3 Comlink

- 81. Comset
- 81. Vehicle Comlink
- 81. Portable Message Transceiver
- 81. Visual Wrist Com
- 81. Holo Display Comlink
- 82. Holo Communicator
- 82. Hologram Projection Pod
- 82. Villip

Communication Disruptors

- 83. Alliance Communications Encrypter
- 83. Pocket Scrambler
- 83. Jammer Pack

Communication Aids

- 83. Anomid Vocalizer Mask
- 83. Qwohog Vocalizer Mask
- 84. AlienEnhancer Voicebox
- 84. Transliterator
- 84. Tizowyrn

Beacons

- 84. Landing Beacon
- 84. Distress Beacon
- 84. Portable Emergency Beacon

Information

Computers

- 85. Datapad
- 85. MicroThrust Portable Computer
- 85. Handheld Computer
- 86. Private Computer
- 86. Mainframe
- 86. Duros Bio-Computer
- 86. Mon Calamari Aquatic Computer
- 86. TerexComm DataSearch 9C
- 86. TerexComm DataSearch 12C-A
- 87. CFC-100 Corporate Watcher Computer
- 87. Galactic Currency Converter
- 87. Pocket Secretary
- 87. Tag Scanner Datapad
- 87. Permit Datapad
- 87. Dodonna's Battle Analysis Computer
- 87. Personal Combat Threat Analyzer
- 88. Spot-On Locator
- 88. Automap
- 88. Navigation/Direction Finder
- 88. Directional Transponder

Accessories

- 89. Dedicated Terminal
- 89. Master Command Unit
- 89. Universal Computer Interface
- 89. Datapad Remote Link Unit
- 89. Cyborg/Computer Systems Data-Link
- 89. Synoptic Teacher
- 90. Remote Text Data Scanner
- 90. Crate Tag Imprinter

Data Carriers

- 90. Electronic Identification Display
- 90. Mem-Stik
- 90. Cyborg Knowledge Cartridges
- 91. Vessel Courier System
- 91. Code Cylinder
- 91. Datadagger

- 91. Jedi Holocron
- 92. Sith Holocron
- 92. Sith Scroll
- 92. Marker Placard

Recorders & Projectors

- 92. Recording Rod
- 92. Treaty Recording System
- 92. Biorecorder
- 93. Chilab
- 93. Gorondin Holo Chronometer
- 93. Imagecaster
- 93. Hologram Projector

Information Security

- 94. AccuTronics Encryption Package
- 94. Analysis Encoding Computer
- 94. DCD-4800 Cryptographer Coder
- 94. Data Bio-Encryptor
- 94. Credit Chip Bio-Encoder

Slicing

- 95. Scomp Spiker
- 95. Computer Spikes
- 95. Unitech "Patch"

Surveillance

Binoculars

- 96. Dim Goggles
- 96. Macrolenses
- 96. Wide-Scan Binocs
- 96. Ziko 1000 Macrobinoculars
- 96. Macrobinoculars
- 97. Headstrap Macrobinoculars
- 97. Holorecording Macrobinoculars
- 97. Experimental Holorecording Macrobinoculars
- 97. Infra-Goggles
- 98. Snooper Goggles
- 98. Peer Snooper Goggles
- 98. Das'skar Hunting Mask
- 98. Kavaavik

Sensors

- 98. Hover-Cam
- 98. Eye In The Sky
- 99. General Purpose Scanner
- 99. Sensor Pack 9320/B
- 99. Surveillance Pod
- 99. Sensor Beacon
- 99. Motion Sensor Pack
- 99. Motion Sensor Array
- 100. Gotal Electromagnetic Scanner
- 100. Lifedetec Bioscanner
- 100. ILF-5000 Lifeform Scanner
- 100. Lifeform Scanner
- 100. Sensor Pack
- 100. Audio Pickup
- 101. "EAR" Eavesdropping Unit
- 101. Comm Scanner
- 101. Orbital Transmission Monitor
- 101. Energy Scanner
- 101. PX-7 Heat Sensor
- 102. Food Analyzer
- 102. ChaumScanner 5 Brooch
- 102. Tox Detector
- 102. Sniffer
- 102. BlasTech Sniffer Weapons Detector
- 102. CorSec Autoscan Weapon Detector

- 102. Search-Scan 4 Security Scanner
- 103. Veridicator
- 103. Force Detector
- 103. Measuring Scanner
- 103. Geological Scanner
- 103. Holographic Ore Scanner
- 103. Focused Uni-Direction Sensor Dish
- 104. Omni-Directional Sensor Globe
- 104. Omniprobe Sensor Array
- 104. Installation Sensor Array
- 104. Sensor Array

Tracking Devices

- 105. Personal Transponder
- 105. Tagger
- 105. Trailmaster Tracking Device
- 105. Observer Tracking Device
- 105. Rover Tracking Device
- 105. SureSnoop Tracking Device
- 105. Slave Tracking Device
- 105. "Keeper" Vec-Tech Subdermal Control System
- 106. Crab Tracer
- 106. ShipFinder
- 106. Imperial XX-23 S-Thread Tracker

Anti-Surveillance

- 106. Dalabar Surveillance Detector
- 106. Smoke Generator
- 107. Instamist Generator
- 107. Camo-Netting
- 107. View Masker
- 107. Voice Scrambler
- 107. Silence Bubble Generator
- 107. Sound Bubble
- 108. Disruption Bubble Generator
- 108. Heat Pod
- 108. Sensor No-Show
- 108. Sensor Jammer
- 108. Sensor Scrambler
- 108. Sensor Blind

Security

Sensor Trips

- 109. Pressure Plate Trip
- 109. Laser Detection Trip
- 109. Repulsorfield Trip
- 109. Motion Sensor Trip
- 110. Heat Sensor Trip
- 110. SoroSuub Heat Sensor Trip

Defense

- 110. Stun Steps
- 110. Monofilament Screen Guards

Locking Systems

- 111. Imperial Customs Holoseal
- 111. Magna Lock
- 111. Bith Computer Retinal Lock
- 111. Bith Vehicle Voice Lock
- 111. Key Card Ship's Lock
- 112. Electronic Combination Hatch Lock
- 112. Remote Control Hatch Lock
- 112. Console Lock Panel
- 112. Console Dead Lock

Storage Devices

- 112. Spacer's Chest
- 112. Sleight Box
- 112. Bith Hiding Cube
- 113. Chronometer with Hidden Compartment
- 113. Thermal Credit Belt

Restraining Devices

- 113. Binder Cuffs
- 113. Magnacuffs
- 114. Magnaharness
- 114. Biodegradable Binders
- 114. Stun Cuffs
- 114. SC-401 Stun Cuffs/Remote
- 114. Yuuzhan Vong Cuffs
- 114. Security Collar
- 114. Neural Control Collar
- 115. Slave Collar (and Director Unit)
- 115. Electro-Collar
- 115. Bio-Cocoon
- 115. Man Trap
- 115. Restraint Capsule
- 116. Force Cage
- 116. Universal Energy Cage

Anti-Security

- 116. Code Slicer
- 116. Security Kit
- 116. Lock Breaking Kit
- 116. Electronic Lock Breaker
- 117. Master Coder Chip
- 117. VoiceBox
- 117. Retinal Disguiser
- 117. Fingerprint Masquer
- 117. Shipjacking Kit
- 118. Tri-laser Engraver

Disguises

- 118. Disguise Kit
- 118. Flesh Camouflage
- 118. Oogith Masquer
- 118. Shadowcloak
- 119. DimSim
- 119. Holographic Image Disguiser
- 119. Doubler Suit

Droid Gear

- 120. Fine Work Grasper Arm
- 120. Heavy Grasper Arm
- 120. Cargo Winch
- 120. Line Caster
- 120. Digging Claws
- 120. Circular Saw
- 121. Welding Laser
- 121. Stun Field
- 121. Storage Compartment
- 121. Sensor-Shielded Storage Compartment
- 121. Internal Comlink
- 121. Subspace Tight-Beam Transmission Core
- 122. Astromech Voice Box
- 122. Modified Tranlang III Module
- 122. Holocam
- 122. Holoprojector
- 122. Intellex IV Internal Computer
- 123. Internal Automap
- 123. Astrogation Buffer
- 123. Scomp-Link

Owner Gear

- 123. CL-3 Droid Command Link
- 123. Cyborg/Droid Interface
- 124. Mk-11 Droid Diagnostic
- 124. Droid Customization Kit
- 125. Restraining Bolt
- 125. Droid Caller
- 125. Restraining Bolt & Owner

Ship & Vehicle Equipment

Onboard Computers

- 126. Vehicle Remote Activation Controller
- 126. Personal Vehicle Coordinator
- 126. CD-12a Autopilot Droid Brain
- 127. Imperial Neural Interface Device
- 127. System Diagnostic Filter
- 127. Archaic Atrogation Plotter
- 127. Alliance MasterNav
- 127. Nav Computer Bypass

Sensor Countermeasures

- 128. Comm Jammer
- 128. Sensor Jammer
- 128. Sensor Jamming Hardware
- 128. Sensor Mask
- 128. Sensor Baffling
- 128. "Mimic" Decoy
- 129. "Trickster" Sensor Decoys
- 129. Copycat Pod

Drives

- 129. SoroSuub Boav Ion Drive
- 129. Incom Starslinger Ion Drive
- 129. Corellian Evader-GT Ion Drive
- 129. Boshaa-C'hi Ion Drive
- 129. Starscream-9 Ion Drive
- 130. Baffled Drive
- 130. x5 Hyperdrive
- 130. x4 Hyperdrive
- 130. x3 Hyperdrive
- 130. x2 Hyperdrive
- 130. x1 Hyperdrive
- 130. Hyperdrive Booster

Tools

- 131. Cargo Netting
- 131. Loader's Gloves
- 131. Crate Hooks
- 131. Gear Bag
- 131. Corrosion Preventative
- 131. Tech Scanner
- 131. Power Scanner
- 131. Starship Tool Kit
- 131. Tasari Mining Kit
- 132. Hydrospanner
- 132. Servodriver
- 132. Laser Welder
- 132. Power Prybar
- 132. Squib Battering Ram
- 132. Fusion Cutter
- 132. Heavy Fusion Cutter
- 132. Portable Plasma Cutter
- 133. Plasma Punch

Miscellaneous

- 133. Plasma Torch Boarding Device
- 133. Cotterdam Universal Airlock

- 134. Universal Airlock
- 134. Givin Emergency Vacuum Seal
- 134. Personal Forcefield Generator
- 134. Deflector Shields
- 134. Cargo-Mover Tractor Beam
- 134. Tractor Beam
- 134. Backup Battery

Miscellaneous

Mystical Items

- 135. Kasha Meditation Crystal
- 135. Life Crystal
- 135. Kaiburr Crystal
- 135. Void Stone
- 136. The Codex
- 136. The Bracers of Najus
- 136. Sith Translation Talisman
- 136. Sith Force Mask Talisman
- 136. Sith Concentration Talisman
- 137. Sith Shield Talisman
- 137. Sith Healing Talisman
- 137. Sith Ensnarement Talisman
- 137. Sith Abattar
- 137. Sith Sarcophagus

Entertainment

- 138. Coruscant Cascader
- 138. Aqualish Bio-Light Panel
- 138. Synth-Harmonica
- 138. Kloo Horn
- 138. Chidinkalu
- 138. Spheroids Globe
- 139. Declination Mental Combat Game
- 139. Holomatic Dejarik Set
- 139. B'shingh
- 139. Imperial Command Combat Simulator

Household

- 140. Universal Power Adaptor
- 140. Cold Crate
- 140. Hot Box
- 140. Food Manager
- 140. Dispersion Canister
- 140. Refresher Booth
- 141. Repulsor Lounge Floater
- 141. Sun Room

Protective Gear

Protective Vests

Leather Jerkin

Model: Kamperdine Clothing Specialists Leather Jerkin
Type: Leather jerkin
Scale: Character
Cost: 300 (+150 for custom-fitting)
Availability: 1
Game Notes: Provides +1 to resist physical damage.
Source: Arms and Equipment Guide (page 42)

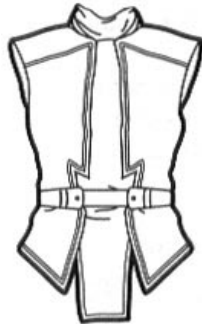

Tracker Utility Vest

Model: Ayelixe/Krongbing textiles Tracker Utility Vest
Type: Utility vest
Scale: Character
Cost: 300
Availability: 2
Game Notes: Provides +1 to resist physical damage. The vest can carry up to 28 objects of 1 kilogram or less, each in one of a series of pockets, pouches and straps.
Source: Arms and Equipment Guide (page 41)



CV14-B Concussion Vest

Model: Core World Arms CV14-B
Type: Personal armor
Scale: Character
Cost: 500
Availability: 1
Game Notes: Torso: +1D to front and back from physical (non-energy) attacks, including crash and falling damage.
Source: Gundark's Fantastic Technology (page 52), Tales of the Jedi Companion (page 124)

Blast Vest



Model: Typical blast vest
Type: Personal armor
Scale: Character
Cost: 300
Availability: 1
Game Notes: +1D physical, +1 energy (torso).
Source: Rulebook (page 234)

Koromondain Half-Vest

Model: Modified Koromondain PDS, Inc. Mk 45 Protective Vest
Type: Protective vest
Cost: 250
Availability: 1
Game Notes: +1D+2 from physical; +2 from energy attacks to torso front and back.
Source: Gundark's Fantastic Technology (page 56), Galaxy Guide 10: Bounty Hunters (page 87)

Corondexx Blast Vest

Model: Corondexx Blast Vest

Type: Protective vest

Cost: 3,000; 25 (power cells)

Availability: 2

Game Effects:

Protective Vest: The power cells project an ablative power screen that adds +1D for energy attacks; +2 physical attacks. Torso only.

Power Cell Storage: Vest can store six standard power cells. Cells are drained in 10 minutes of continuous operation.

Power Jacks: In place of power cells, the vest has power jacks allowing a small capacitor to be charged from a portable power generator. Requires one hour to charge and the capacitor can power the vest for two minutes of continuous operation.

Source: Galaxy Guide 10: Bounty Hunters (page 87), Gundark's Fantastic Technology (page 49)

Barabel Microbe Armor

Model: Creshaldyne Industries Barabel Microbe Armor

Type: Biological blast vest

Cost: 30,000

Availability: 4

Game Notes: vest initially gives +1D to resist damage from blaster attacks to front and back torso. With each subsequent hit by a blaster bolt, the vest goes up by one pip (+1D, +1D+1, +1D+2, +2D, etc.) up to a maximum of 3D. The vest drops by one pip for every three minutes the vest is not hit by a blast. If a blast penetrates the vest enough to allow the user to be wounded, the vest is destroyed. If exposed to below-zero temperatures for as little as 15 minutes, the vest is destroyed.

Source: Galladinium's Fantastic Technology (pages 85-86), Arms and Equipment Guide (pages 41-42)



Massassi Chest Shield

Model: Massassi Chest Shield

Type: Alchemically-treated body armor

Scale: Character

Cost: Not available for sale

Availability: 4, X

Game Notes: This is a Massassi warrior's primary body armor. It consists of an alchemically-treated shield strapped to the warrior's chest which allows increased freedom of movement. It provides +1D+1 to *Strength* rolls made to resist physical and energy damage to the chest only, and reduces the wearer's *Dexterity* by -1 pip.

Source: The Dark Side Sourcebook (page 114)

Armor Accessories

Rock Boots

Model: Malik Industries Rock Boots

Type: Survival boots

Cost: 50-200 (depending on species)

Availability: 2

Game Notes: Reinforced footwear designed to resist the harsh surface of volcanic badlands.

Source: Goroath, Slave of the Empire (page 86)

CT3 Concussion Helmet

Model: Core World Arms CT3

Type: Personal armor

Scale: Character

Cost: 375

Availability: 1

Game Notes: Head: +2 to front and back from physical (non-energy) attacks, including crash and falling damage.

Source: Gundark's Fantastic Technology (pages 51-52), Tales of the Jedi Companion (page 124)

Blast Helmet



Model: Typical blast helmet

Type: Personal armor

Scale: Character

Cost: 300

Availability: 1

Game Notes: +1D physical, +1 energy (head).

Source: Rulebook (page 234)

Sonic Dampening Helmet

Model: Pacnorval Sonic Dampening Helmet

Type: Sonic dampening helmet

Scale: Character

Cost: 600

Availability: 2

Game Notes: Provides +3D to resist sonic attacks.

Source: Arms and Equipment Guide (page 45)

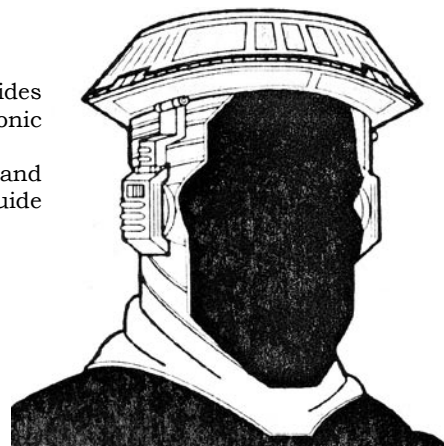

Camouflage Armor

Umbaran Shadowcloak

Type: Camouflage cloak

Scale: Character

Cost: 5,000

Availability: 4

Game Notes: Sensors sewn into the fabric allows an Umbaran who dons the cloak to alter its coloration, allowing the wearer to blend more easily into the surroundings (+1D to *hide*). Only Umbarans can control the color-shifting property of a shadowcloak.

Source: Ultimate Alien Anthology (page 176)

Camouflage Poncho

Model: A/KT Camouflage Poncho

Type: Cloth fatigues

Cost: 250

Availability: 1

Game Notes: Adds +1D to *sneak*, +2D at ranges of more than 35 meters.

Source: Rules of Engagement – The Rebel SpecForce Handbook (page 33), Arms and Equipment Guide (page 45), Ultimate Adversaries (page 154)



Camouflage Fatigue

Model: Typical camouflage fatigue

Type: Military fatigue

Availability: 3

Game Notes: +2D to *sneak* in forest at ranges of 35+

Source: Galaxy Guide 5: Return of the Jedi (page 62)



Shadowsuit

Model: Ayellixe/Krongbing Textiles Shadowsuit

Type: Anti-sensor suit

Cost: 600

Availability: 3

Game Notes: Adds +2D to *sneak*.

Source: Rules of Engagement – The Rebel SpecForce Handbook (page 34), Arms and Equipment Guide (page 40)

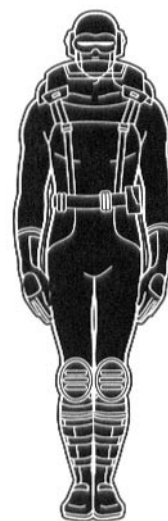

Camo Armor

Model: Creshaldyne Industries Scout Armor

Type: Light scout armor

Cost: 1,500

Availability: 2

Game Effects:

Basic Suit: +1D physical, +2 energy for torso, arms and legs.

Camo Field: +1D to difficulty of *search* or *Perception* rolls for those trying to spot the wearer if the wearer remains motionless.

Source: Galaxy Guide 10: Bounty Hunters (page 87), Gundark's Fantastic Technology (pages 49-50), Rules of Engagement – The Rebel SpecForce Handbook (page 34), Arms and Equipment Guide (page 43)

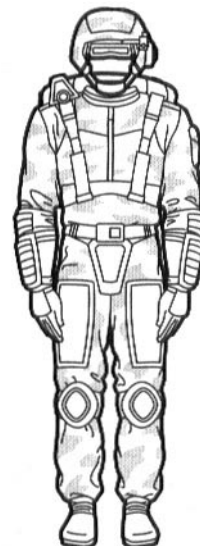

Thermoguard Jumpsuit

Model: Thermoguard Jumpsuit

Type: Anti-infrared sensor suit

Scale: Character

Cost: 2,500

Availability: 3

Game Notes: This jumpsuit makes the wearer invisible to infrared detection devices, and negates the benefits of "darkvision." Beings with normal sight or darkvision can still see the wearer, though they are subject to normal concealment penalties for darkness (if any). Beings and creatures that are blind without darkvision cannot see the wearer at all. This jumpsuit can be turned on and off, and it takes one full minute to reach the correct temperature. If turned off, its effects fade within thirty seconds. The jumpsuit uses standard power packs, and one power pack is good for two hours of use. The suit is confining, and wearers suffer a -1 penalty to *Dexterity*.

Source: Gamer Magazine

Environmental Suits

Shipsuit

Model: Ayelic/Krongbing Textiles Shipsuit

Type: General purpose shipsuit

Cost: 200

Availability: 1

Game Notes: Multi-pocketed coverall, fireproof and electrically nonconductive.

Source: Gundark's Fantastic Technology (page 76), Pirates & Privateers (page 47)



Body Glove

Model: Kamperdine Clothing Specialists CSC-5000

Type: Luxury temperature control suit

Cost: 700

Availability: 3

Game Notes: Upper torso to foot coverage. Normal wear adds +1 to any subsequent *survival* or *stamina* rolls in harsh environmental conditions.

Source: Galladinium's Fantastic Technology (page 42)



All-Temperature Cloak

Type: Typical weather cloak

Scale: Character

Cost: 100

Availability: 1

Game Notes: Provides a +2 bonus to *stamina* checks to resist severe weather.

Source: d20 Core Rulebook (page 140)



Morseerian Environmental Suit



Model: Morseerian Environmental Suit

Type: Methane survival suit

Cost: 1,500

Availability: 3

Game Notes: In addition to creating an artificial atmosphere capable of sustaining its wearer indefinitely, the suit and mask protect the wearer against harmful gases. It continues to function even when punctured by weapons and blaster fire.

Source: Ultimate Alien Anthology (page 100)

Thinsuit

Model: Karflo Corporation Thinsuit

Type: Insulation armor

Cost: 900

Availability: 2

Game Notes: +1 against physical attacks. Provides up to 18 hours of limited protection against chemical exposure in most known atmosphere types and temperature extremes from -30 to 100 degrees. Breath mask with extended filter (lasts up to 6 hours), storage room for up to 5 more filters. Can be worn in space, providing heat and protection for nearly one hour, however it does not contain air supply.

Source: Galaxy Guide 8: Scouts (page 45), Rules of Engagement – The Rebel SpecForce Handbook (page 33), Arms and Equipment Guide (page 42)



Ooglith Cloaker

Model: Yuuzhan Vong Ooglith Cloaker

Type: Organic environment suit

Scale: Character

Cost: Not available for sale

Availability: 4, X

Game Notes: The ooglith cloaker is an organic environment suit, and is typically used in conjunction with a gnullith. It is painful to wear, inflicting 2D damage to the wearer every time it is worn. It can be released by pressing a hidden organ. Anyone unaware of this organic switch can succeed at a Difficult *Knowledge* check to discover it.

Source: The New Jedi Order Sourcebook (pages 22-23)



Game Notes: Adds +1 to resist damage, +1D to *sneak* in natural terrain. Integrated equipment harness and helmet with breath mask (6-hour filter) and macrobinocular visor.

Source: Rules of Engagement – The Rebel SpecForce Handbook (pages 33-34)

Lightweight Armor



Type: Exploration armor

Availability: 2

Game Notes: +1 to *Strength* to resist damage; helmet contains a breath mask with extended filter (lasts up to 6 hours) and macrobinoculars fitted into the visor; utility belt with several pouches, usually worn with an integrated version of the Multipack; camouflage adds +1D to *sneak* while in natural terrain.

Source: Galaxy Guide 8: Scouts (page 45)

Light Scout Armor

Model: Voyage Enterprises Scout Armor

Type: Lightweight armor suit

Cost: 700

Availability: 2

Scout Armor

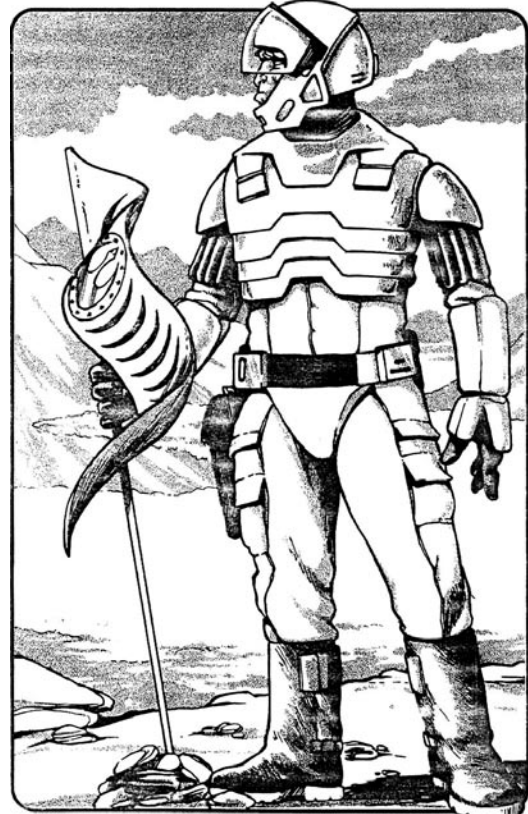

Type: Typical scout armor

Availability: 3

Game Notes: +2 to *Strength* to resist damage, no *Dexterity* penalties. Breather and heater units make it usable in areas with little or no atmosphere, but not the vacuum of space.

Source: Galaxy Guide 8: Scouts (page 45)

A-5 Envirosuit



Model: Malik Technologies A-5 Envirosuit

Type: Survival suit

Cost: 1,000

Availability: 2

Game Notes: Provides +2 to all physical attacks; +1 to all energy attacks for torso, arms, and legs. Provides +1 to all physical attacks for head (no protection from energy attacks); -1D penalty to all *Dexterity* attribute and skill checks due to bulk. Provides a full, sealed environment, protecting from radiation, environmental contaminants and extreme temperatures from -60° C to 150° C. Recycled air supply lasts 6 hours and backpack batteries last 10 hours (4 hours under extreme temperatures). Helmet is equipped with spotlight.

Source: Goroth, Slave of the Empire (pages 84-86)

SeaScape Diving Suit

Model: SeaScape Aquasuit (Hardshell model)

Type: Heavy diving suit

Scale: Character

Skill: Swimming

Cost: 400

Availability: 1 in coastal areas, 2 elsewhere

Game Notes: The reinforced ribbing adds 2 pips to *Strength* code for damage purposes only. Only reduces *Dexterity* codes on land. The flippers and on-board propulsion unit add +2D to the user's *swimming* skill and allow an underwater Move rate of 12. Air tanks contain enough air for six hours of continuous use, and ribbing plates allow dives to 200 meters. There is a comlink in the helmet with a range of two kilometers.

Source: The Best of the Adventure Journals – Issues 1-4 (page 67), Gundark's Fantastic Technology (page 60)

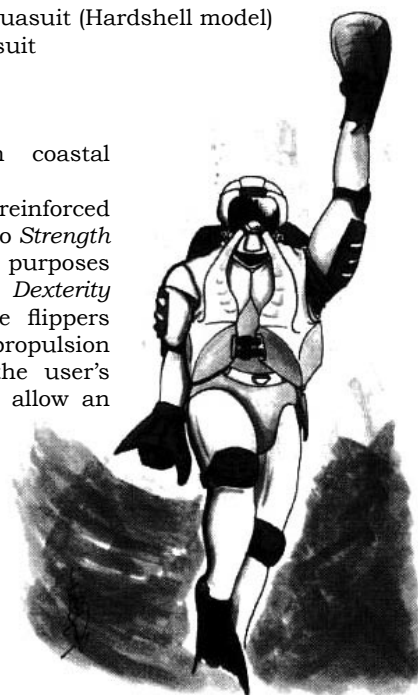

Skakoan Pressure Suit

Model: Skakoan Pressure Suit

Type: Environment suit

Scale: Character

Cost: 1,000 (light), 4,500 (medium), 11,000 (heavy)

Availability: 4 (available only on Skako or through the Techno Union)

Game Notes: The Skakoan designed three different types of pressure suits to protect them from the adverse effects of atmospheres other than the one found on their homeworld:

Light Pressure Suit: +1D physical, +1 energy.

Medium Pressure Suit: +1D+2 physical, +1D energy, -1 to *Dexterity*.

Heavy Pressure Suit: +2D+1 physical, +1D+1 energy, -1D to *Dexterity*.

All Skakoan pressure suits incorporate a vocalizer that distorts the wearer's speech patterns, making it difficult to tell one suited Skakoan from another. If an attack deals a

Wounded result on a suit's wearer, there's a 50% that the suit will rupture, exposing its wearer to hostile atmospheric conditions. Although not designed for it, the pressure suit can protect a non-Skakoan from the harmful effects of Skako's dense, oxygen-poor atmosphere.

Source: Ultimate Alien Anthology (page 143)



Versatex Survival Suit

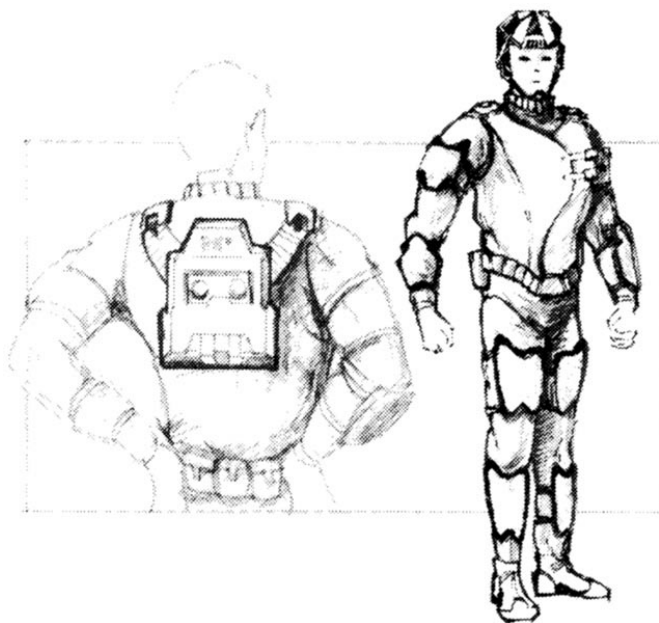

Model: Vectac Systems Inc. Versatex Survival Suit
Type: Personal survival suit
Cost: 900, 150 (armor plates), 5 (replacement dye concentrate capsules, 5 colors available)
Availability: 2

Game Notes: Suit is waterproof and tear and pressure resistant. Micro-capillared fabric's insulation fluids protect the wearer from temperature extremes from as low as -30° C to as high as 100° C. Suit's microcapillaries have a limited camouflage system. By exposing the belt color sensor to the environment's predominant color, custom tinted dyes will be injected into the micro-capillaries, altering the suit's color, granting a +1D bonus to *sneak* and *hide*. Helmet has a built-in comlink, breath mask and glowlamp. Optional strap-on armor provides +1D physical and +2 energy protection, retaining the same camouflage capabilities.
Source: Galladinium's Fantastic Technology (page 57)

Polarizing Field Insulator Suit

Model: VargeCorp Polarizing Field Insulator Suit
Type: Insulator suit
Scale: Character
Cost: 3,000
Availability: 2

Game Notes: +1 to resist damage, -2D to *Dexterity*. When the polarizing field is turned on it generates a 4-meter-diameter insulation field that has 8D resistance against electricity/ion energy. A generator can operate for 30 minutes on a standard power pack.

Source: Arms and Equipment Guide (page 43)

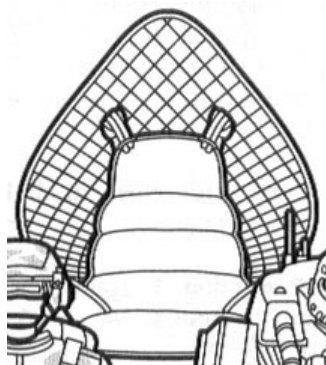

Spacesuits

Vacuum Oogloth

Model: Yuuzhan Vong Vacuum Oogloth
Type: Organic vacuum suit
Cost: Not available for sale
Availability: 4, X

Game Notes: The vacuum oogloth is a variant of the oogloth cloaker that works in the vacuum of space. The vacuum oogloth only protects the wearer against the rigors of space, and in no way does it provide the wearer with any oxygen supply. Typically used in conjunction with a lungworm.

Source: The New Jedi Order Sourcebook (pages 21-22)

Vacuum Suit

Model: Incom Military Vacuum Suit
Type: Personal vacuum suit
Cost: 1,100
Availability: 1

Game Notes: Incom developed this version of the military flight suit decades ago; it is in common usage throughout the galaxy. It contains 10 hours worth of atmosphere. A player character in space must make a Moderate *stamina* or *Strength* check every hour or he or she is exposed to vacuum or suffer a wound caused by the freezing cold of space.

Source: Rulebook (pages 227-228)

Tech Vacuum Suit

Model: LifeLine TechMaster II Vacuum Suit
Type: Tech vacuum suit
Cost: 1,000
Availability: 1

Game Notes: Since It's insulated, not heated, a character in space must make a Moderate *stamina* or *Strength* roll every hour or suffer a wound caused by the freezing cold.

Source: Platt's Smugglers Guide (pages 58-59)

LifeLine Space Suit

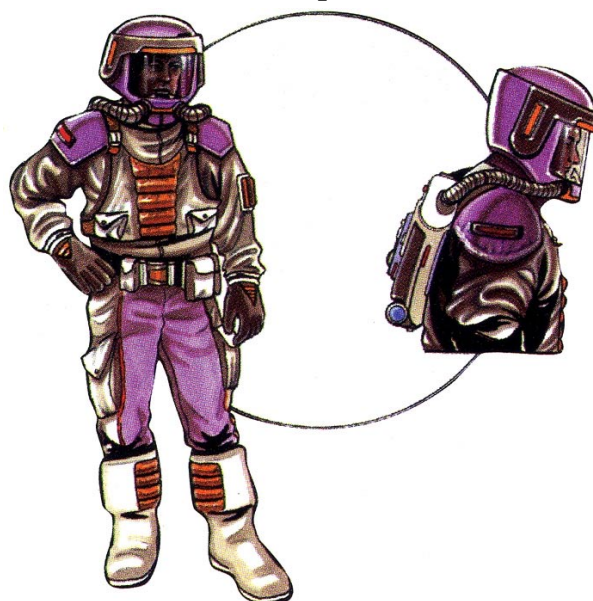

Model: LifeLine Technologies Model 11 Space Suit

Type: Personal space suit

Cost: 2,200

Availability: 2, F

Game Notes: The LifeLine Model 11 contains a heating unit, waste recycling and onboard food supply. The suit's power supply, atmosphere and food supply will support a character for 10 standard days. The wearer suffers a -2D to all *Dexterity* attribute and skill checks.

Source: Rulebook (pages 227-228)

Flight Suit



Type: Typical flight suit

Scale: Character

Cost: 250

Availability: 1

Game Notes: The flight suit is a one-piece coverall (plus helmet) that provides life support, protects the wearer from hostile environments, and prevents the wearer from succumbing to the adverse effects of high-velocity flying.

Source: d20 Core Rulebook (page 142)

Padded Flight Suit

Type: Typical padded flight suit

Scale: Character

Cost: 800

Availability: 1

Game Notes: Provides +1 to *Strength* to resist physical damage and additional protection against decompression, g-forces and harmful environments. Comes with a matching helmet and



gloves that seal around the wearer and provide up to 10 hours of life support in a hostile environment. It grants a +2 bonus to *stamina* to resist cold temperatures.

Source: d20 Core Rulebook (page 139)

Armored Flight Suit

Model: Corellian TX-3

Type: Armored flight suit

Scale: Character

Cost: 4,000

Availability: 2

Game Notes: Provides +2 to *Strength* to resist damage and additional protection against vacuum for limited periods. It grants a +1D+1 bonus to *stamina* to resist cold temperatures.

Source: d20 Core Rulebook (page 138)



Flitter Vacuum Suit

Model: Regallis Engineering Flitter Suit

Type: Tech rocket pack vacuum suit

Skill: Rocket pack operation

Cost: 1,500

Availability: 2

Game Notes: The suit's reinforced fabric and durable construction provides +2 bonus when resisting physical attacks. Unless a character in space executes a "heater burn", she must make a Moderate *stamina* or *Strength* check every hour or suffer a wound caused by the freezing cold.

Source: Platt's Smugglers Guide (page 59)

Vagabond Suit

Model: Customized Vagabond Space Suit

Type: Deep space powersuit

Scale: Character

Skill: Powersuit operation

Cost: 2,500

Availability: 3

Game Notes: Add +2D to *sensors* and *communications* rolls while suit is used independent of a base ship. Add +1D if linked to base ship. The suit's armor provides +2D against physical attacks. Booster jets provide a top speed equivalent of Space 1 with a maneuverability of 1D. The on-board sensor array has the following specifications:

Passive: 3/0D

Scan: 6/0D

Search: 9/1D

Focus: 1/2D

Source: Gundark's Fantastic Technology (page 62)



Bulk Exploratory Armor

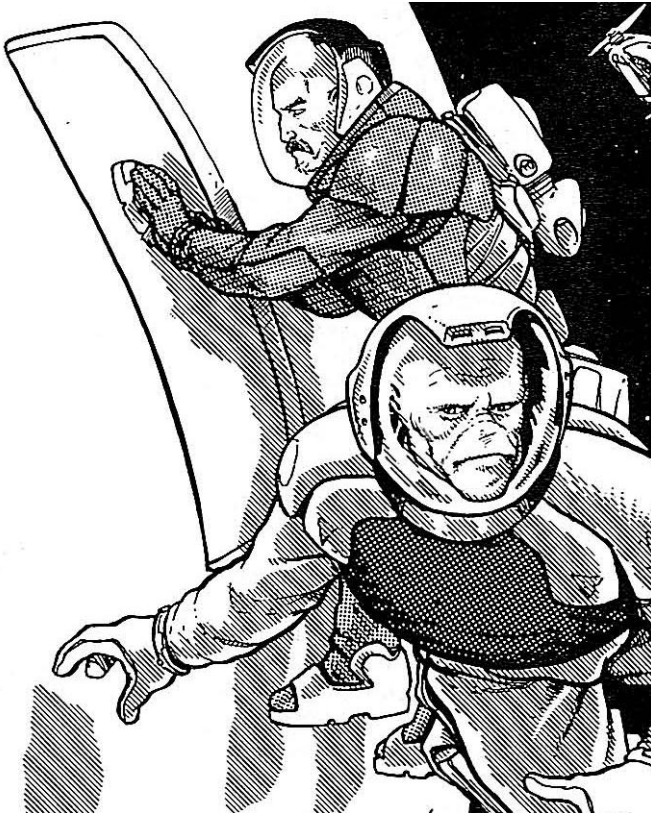

Type: Exploration armor

Availability: 3

Game Notes: +1D to resist damage, -1D to *Dexterity*. Sealed environment stands up to the harshest weather or atmospheres. Rebreather and oxygen cylinders. Removable weight boots with magnetic soles. Small tool and utility belt. Helmet is equipped with comlink and overhead flashlight.

Source: Galaxy Guide 8: Scouts (page 45)

Space Suit



Type: Typical space suit

Scale: Character

Game Notes: +1D to resist damage, -1D to *Dexterity* and related skills. Helmet has voice-activated comlink. Atmosphere pack can keep the user comfortably supplied with oxygen for six hours of vigorous activity. Fine

manipulation is not possible with the heavy gloves. Normal blasters can't be used, unless modifications involving the removal of trigger guards and addition of trigger extensions are made (an Easy *blaster repair* task that takes one hour). Characters firing jury-rigged weapons reduce their *blaster* skill by 1D.

Source: The Abduction of Crying Dawn Singer (page 28)

Armored Vacuum Suit

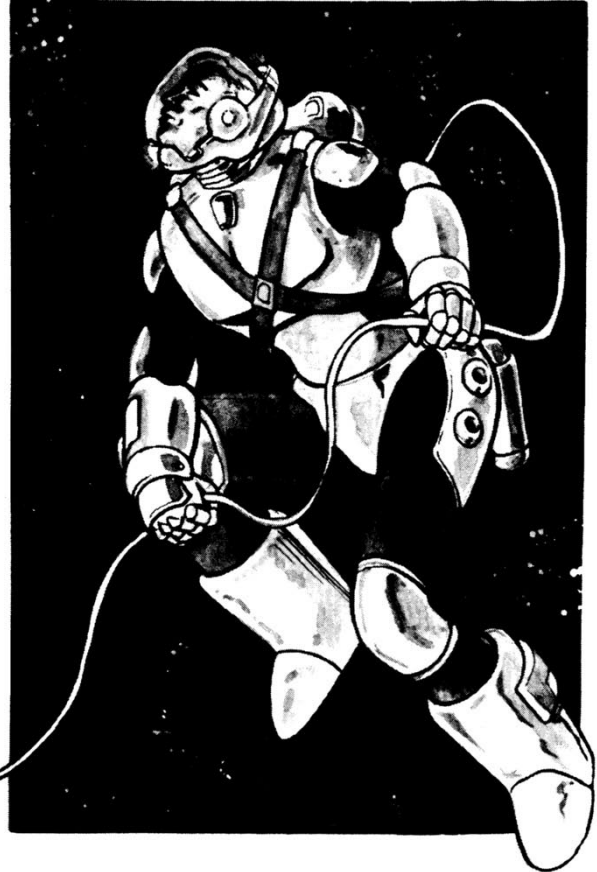

Model: Corellian Technologies Boarding Armor

Type: Armored vacuum suit

Cost: 4,000 credits

Availability: 2, R

Game Notes:

Armor: +1D versus physical and energy attacks.

Vacuum: Holds 10 hours of atmosphere; user must make Moderate *stamina* check every hour exposed to space or suffer a wound.

Source: Gundark's Fantastic Technology (pages 48-49), Pirates & Privateers (page 45)

Wrokix Works Armored Spacesuit

Model: Wrokix Works Deluxe Boarding Armor

Type: Armored spacesuit

Scale: Character

Cost: 8,500

Availability: 2

Game Notes: Body: space helmet and body armor +1D from all energy attacks, +2D from all physical attacks, -1D from *Dexterity* attribute and skills. Has life support for five hours and internal gyro stabilizer adding +1D to *Dexterity* for zero gravity situations.

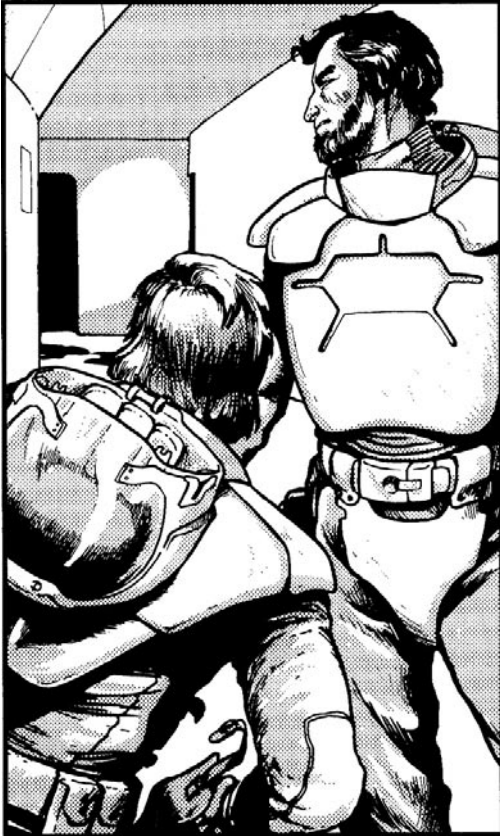

Source: Gundark's Fantastic Technology (page 63), Han Solo and the Corporate Sector Sourcebook (page 122)

Heavy Radiation Powersuit

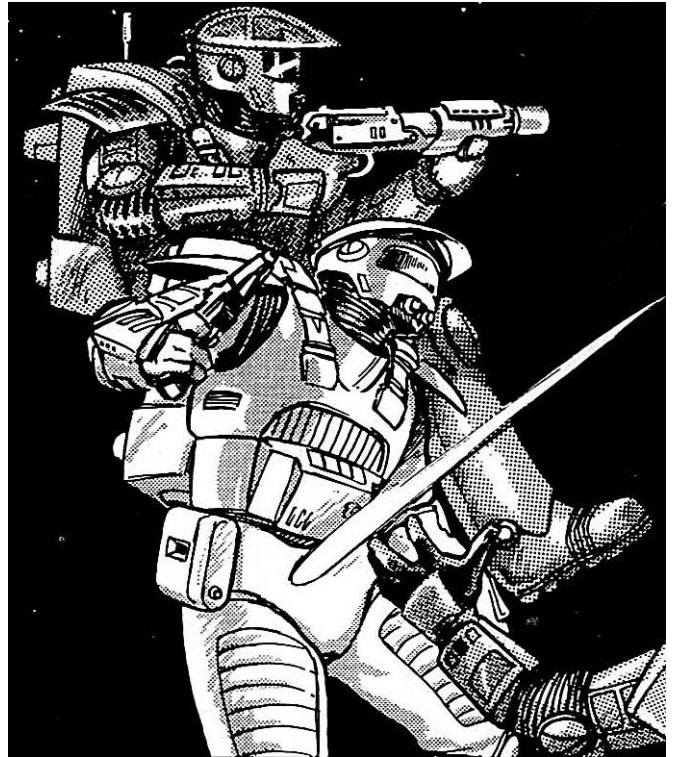

Model: Nova-Tech HR-211 Powersuit

Type: High radiation powersuit

Scale: Character

Skill: Powersuit operation

Cost: 3,000

Availability: 2

Game Notes:

Armor: Provides +2D physical and energy, -1D to *Dexterity* and related skills. Move: 3 (in gravity).

Booster Jets: Detachable booster jets have fuel for 10 bursts, with a speed of Space 1 and 1D maneuverability.

Sensors: The suit is equipped with a sensor pod with a maximum range of 100 meters; add +1D to the operator's *sensors* skill.

Equipment: Helmet-mounted comlink, 12 hours of oxygen, 6-hour power supply, utility pouches, 50 meter lifeline, shoulder-mounted beam light, fusion cutter (5D), and magnetic traction boots.

Source: Gundark's Fantastic Technology (page 55), Operation: Elrood (pages 106-107)

Merr-Sonn Armored Spacesuit

Model: Merr-Sonn Weapons Superior Boarding Armor

Type: Armored space suit

Cost: 10,000

Availability: 2, X

Game Notes:

Armor: Provides +2D versus energy, +1D versus physical damage; -1D from *Dexterity* and related skills. Holds 25 hours of atmosphere.

Rocket Pack: Suit includes a rocket pack; Space Move: 1, uses *rocket pack* operation.

Source: Gundark's Fantastic Technology (page 58), Pirates & Privateers (page 45)

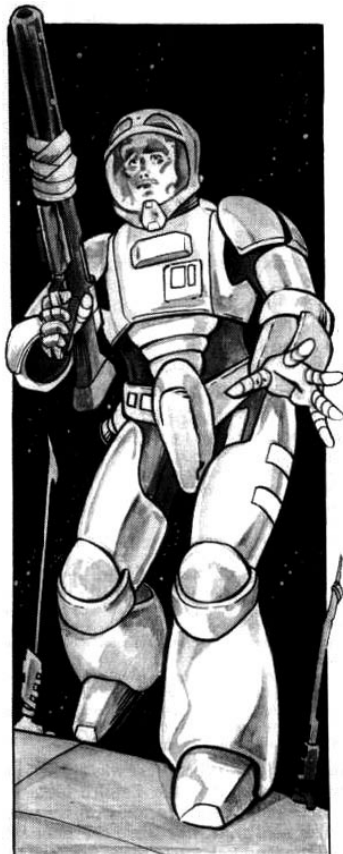

Nova-Tech Powersuit

Model: Nova-tech Powersuit

Type: Space powersuit

Scale: Character

Skill: Powersuit operation

Cost: 1,000

Availability: 2

Game Notes:

Armor: Suit provides +2D energy, +3D physical; maneuverability 1D, space 1.

Weapon: Blaster cannon (fire control 1D, damage 5D)

Source: Gundark's Fantastic Technology (page 59)

EVA Vacuum Pod

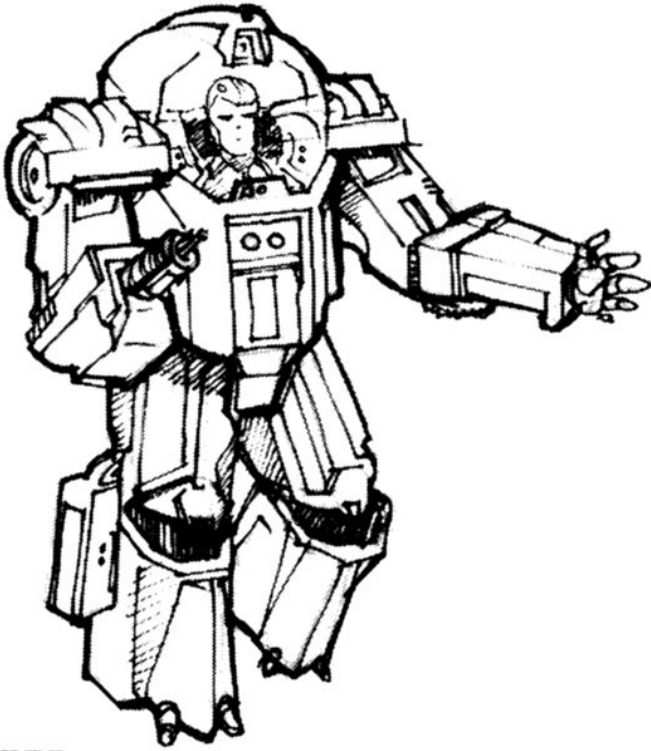

Model: Regallis Engineering EVA Vacuum Pod
Type: Droid-monitored space pod
Skill: Powersuit operation: repair pod
Crew: 1
Cover: Full
Cost: 15,000
Maneuverability: 1D
Move: 55; 160 kmh
Body Strength: 4D
Game Notes: Life support system capable of functioning for 2 hours. Has full comlink system and a number of attachments for the two forward arms, plus an exterior “storage pouch” of additional attachments. An annual maintenance overhaul of each pod (Easy *powersuit repair* total) is required.
Source: Galladinium’s *Fantastic Technology* (page 54), *Arms and Equipment Guide* (page 45)

Combat Armor

Primitive Armor

Type: Leather and hide armor
Scale: Character
Cost: 150
Availability: 2
Game Notes: +1 to resist physical attacks.
Source: *Ultimate Adversaries* (page 155)

Shockball Uniform



Type: Standard shockball uniform
Availability: 1
Game Notes: Padding provides +2 to *Strength* to resist physical damage, helmet provides +1. Insulated mit, scoop.
Source: *Cracken’s Rebel Operatives* (page 77)

Twilek Antistun Suit

Type: Antistun suit
Scale: Character
Cost: 1,000
Availability: 3
Game Notes: This grey mesh uniform grants a +1D bonus to *Strength* to resist stun attacks.
Source: *Ultimate Alien Anthology* (page 172)

Reflect Body Glove

Model: Synchronics ENVC-370 Glove

Type: Protective energy-displacement suit

Cost: 4,000

Availability: 3, X

Game Notes: This suit adds +1D to a character's *Strength* when resisting damage from blaster attacks as long as the person hit was at the weapons's medium or long range (blaster bolts disperse slightly over distance, and the minor dispersal at medium and long range makes blaster bolts much easier for the suit to affect). The suit can absorb five blasts before being destroyed. If the wearer of the suit is wounded (or worse) as the result of an energy blast, the suit is also destroyed.

Source: Galaxy Guide 10: Bounty Hunters (page 88), Gundark's Fantastic Technology (page 59)

Combat Jumpsuit



Model: A/KT Tuff1 Combat Jumpsuit

Type: Light combat armor

Cost: 500

Availability: 2

Game Notes: Provides +1D physical, +2 energy protection.

Source: Galladinium's Fantastic Technology (page 80), Rules of Engagement – The Rebel SpecForce Handbook (page 33), Arms and Equipment Guide (page 41)

Link Armor

Model: ProTech SupraLink

Type: Link armor

Scale: Character

Cost: 500

Availability: 1

Game Notes: Head, torso, arms, legs: +1D to all physical (non-energy) attacks; +2 to all energy attacks; -1D penalty to all *Dexterity* attribute and skill checks.

Possible Modifications: Character may opt to create twin-layer link armor by weaving two suits (one slightly larger

than the other) together. The modification changes the armor's statistics to the following: +1D+2 to all physical attacks; +1D to all energy attacks; -2D to all *Dexterity* attribute and skill checks. The alteration requires a Difficult *armor repair* roll, 550 credits, and one week of work.

Source: Gundark's Fantastic Technology (page 57), Tales of the Jedi Companion (page 124)



Glistaweb

Model: Glistaweb

Type: Yuuzhan Vong personal armor

Scale: Character

Cost: Not available for sale

Availability: 4, X

Game Notes: A robe of shimmering cloth that acts as armor. Grants a +1 pip bonus to *Strength* rolls to resist physical damage, +1D+1 bonus to *Strength* rolls to resist energy damage, and -1 pips to the wearer's *Dexterity* score.

Source: The New Jedi Order Sourcebook (page 22), Ultimate Alien Anthology (pages 192-193)

Blast-Dampening Armor



Model: Creshaldyne Industries Blast-Dampening Armor

Type: Personal armor

Scale: Character

Cost: 6,000

Availability: 2

Game Notes: +1D+1 energy, +1 physical.

Source: Arms and Equipment Guide (page 43)

Flex-Armor

Model: Drolan Plasteel TYI Flex-Armor
Type: Personal armor
Scale: Character
Cost: 2,000
Availability: 3
Game Notes: Head, torso, arms, legs: +1D to all physical and energy attacks; -1D penalty to all *Dexterity* attribute and skill checks.
Possible Modifications: Flex-armor can be reinforced with steel wire mesh, thereby increasing its protection to +2D against physical strikes. Defense against energy attacks, however, is forfeited in the process. This alteration requires a Moderate *armor repair* roll and one day of time.
Source: Gundark's Fantastic Technology (page 54), Tales of the Jedi Companion (page 124)

Castaan Staad Armor

Model: Castaan Staad Armor
Type: Custom-designed Twi'lek warrior armor
Cost: 750
Availability: 3
Game Notes: +1D to physical and +1D to energy, covers torso.
Source: Gundark's Fantastic Technology (page 50)

Electromesh Armor

Model: Nagai Electromesh Armor
Type: Powered armor
Scale: Character
Cost: 12,000
Availability: 4 (available only on Nagi)
Game Notes: +1D+2 energy, +1D physical, -1 to *Dexterity* and related skills. The lightweight, glossy-black, form-fitting suit incorporates an electrical field designed to absorb damage from energy weapons.
Source: Ultimate Alien Anthology (page 104)



Corellian 611 Combat Armor

Model: Corellian 611 Combat Armor
Type: Personal battle armor
Cost: 5,000
Availability: 3, F
Game Notes: provides +2D to *Strength* for physical attacks, +1D for energy attacks. Add +10 to the difficulty number of any *swimming* rolls made while wearing this armor.
Source: Gundark's Fantastic Technology (pages 50-51), Adventure Journal 3 (page 243)

Arelik Armor

Model: Stock Arelik Armor
Type: Personal battle armor
Cost: Not available for sale
Availability: 4, X
Game Notes:
Armor: provides +2D to *Strength* for physical attacks, +1D for energy attacks; -1D to *Dexterity* and related skills. Covers head, torso and arms.
Sensor Pod: +1D to *search*.
Infrared Sensor: Adds +1D to *Perception* in darkness.
Environmental Filter: Helmet filter system can prevent harmful molecules from entering the lungs.
Source: Gundark's Fantastic Technology (page 48)



Fenelar Armor

Model: Fenelar Armor
Type: Antique body armor
Scale: Character
Cost: 55,000 credits
Availability: 4, X
Game Notes: +2D to *Strength* rolls to resist damage from physical attacks, +1D from energy attacks. *Dexterity* is reduced by -1D. The armor's helmet contains motion and sound sensors (+1D bonus to all *search* skill rolls), a comlink, and an infrared imaging system (allows the user to see in the dark up to 30 meters). The forearm bracers contain concealed combat knives (Difficulty: Easy, Damage: STR+1D). Due to the armor's overall design, anyone wearing it gains a +1D bonus to all *intimidation* skill rolls.
Source: Gamer Magazine

Cresh Luck Armor

Model: Modified Creshaldyne Industries Riot Armor
Type: Personal battle armor
Cost: 500
Availability: 2
Game Effects:
Basic Suit: +2D physical; +1D energy for torso (front and back) and legs (front)
Infrared Motion Sensor Array: Has a range of 30 meters. An alarm is triggered when any mass over 10 kilograms is detected traveling in excess of 1 meter per second (this alarm can be audio or be run into a blast helmet for interior audio or visual).
Source: Galaxy Guide 10: Bounty Hunters (page 87), Gundark's Fantastic Technology (page 50)

Ubese Raider Armor

Model: Stock Ubese Raider Armor
Type: Battle armor
Cost: 1,000
Availability: 3
Game Notes:
Basic Suit: +2D to *Strength* for physical attacks, +1D for energy attacks. Covers torso and head only. No *Dexterity* penalties.
Sealed Enviro-Filter: Filter system maintains Type II



atmospheres within helmet, and filters out harmful molecules and odors.

Flash Guard Visor: Nullifies all stun damage from visual sources (for instance, flash canisters or grenades).

Source: Gundark's Fantastic Technology (pages 61-62), Alien Anthology (page 110), Ultimate Alien Anthology (page 174)

Gladiator Armor

Model: Min-Dal JX4 Gladiator Prototype

Type: Personal battle armor

Cost: Not available for sale

Availability: 4, X

Game Notes:

Armor: provides +2D to *Strength* for physical attacks, +1D for energy attacks. Covers head, torso and arms. No *Dexterity* penalties.

Conner Net Gun: Stun damage, damage 5D if electrical charge is released, uses *missile weapons* skill, ranges: 3-10/19/25, mounted on left forearm armor.

Vibro-Shiv: STR+1D damage, retracts into right gauntlet.

Jet Pack: Has Move of 100 meters horizontally, 70 meters vertically. Uses *jet pack operation* skill, base difficulty is Easy, modified by obstacles. Has 10 charges, can expend up to two per round.

Source: Gundark's Fantastic Technology (pages 54-55)

Dura-Armor

Model: Core World Arms Dura-Armor

Type: Impact-resistant molded armor

Scale: Character

Cost: 8,000

Availability: 3

Game Notes: Head, torso, arms, legs: +2D to all physical (non-energy) attacks; +2D to all energy attacks; -2D penalty to all *Dexterity* and *Perception* attribute and skill checks.

Source: Gundark's Fantastic Technology (page 53), Tales of the Jedi Companion (page 124)

Coynite Battle Armor

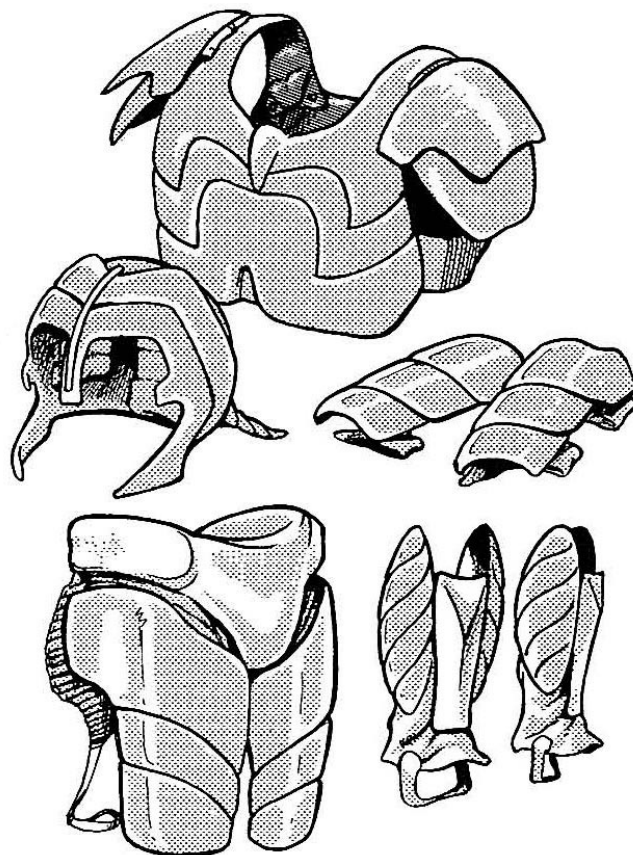

Model: Ekkar Arms Coynite Battle Armor

Type: Coynite personal battle armor

Cost: 150

Availability: 3

Game Notes: Add +2D protection from all physical and energy attacks. All *Dexterity* skills are penalized -1D.

Source: Gundark's Fantastic Technology (page 51), Planets Collection (page 141)

Stalker Armor

Model: Salus Corp Stalker Armor

Type: Personal body armor

Cost: 8,000

Availability: 3, R

Game Notes:

Armor: Provides +2D to *Strength* for physical attacks, +2D to energy attacks; -2D to *Dexterity* and related skills. Covers head, torso, arms and legs.

Heaviness: Due to this suit's weight, the skills *hide*, *sneak* and *swimming* cannot be used while wearing this armor.

Tangle Gun: 4D stun damage, uses *missile weapons* skill, ranges: 3-10/30/60, mounted on right arm.

Duo-Flechette Rifle: 5D damage, uses *armor weapons* skill, ranges: 3-10/30/60, mounted on right forearm armor.

Retractable Claws: STR+2D damage, concealed in right gauntlet.

Sensors: A sensor pod and targeting computer provides +1D to *search*, and +1D to weapons skill rolls.

Source: Gundark's Fantastic Technology (pages 60-61)

M'uhk'gfa Battle Plate

Model: Gamorrean M'uhk'gfa Battle Plate

Type: Gamorrean armor

Scale: Character

Cost: 8,000 (2,000 on Gamorr or Pzob)

Availability: 3

Game Notes: +3D physical, +1D energy, -1D+2 *Dexterity*.

A m'uhk'gfa consists of metal plates bound by thick leather straps. A high, segmented collar protects the neck, thick plates surround the torso, while the heaviest plates adorn the shoulders. Thinner sheets are strapped to the arms, and a heavy helmet, usually bearing oversized prongs that sheath the wearer's own horns, complete the set. Armor takes 4 rounds to put on and 2 rounds to remove (double that time if the wearer does not have assistance).

Source: Ultimate Alien Anthology (page 62)

A3AA Personal Defense Module

Model: Corellian Technologies A3AA

Type: Personal defense system

Ammo: 3

Cost: 8,500 (often much more on the black market)

Availability: 4, X

Game Notes: Generally available only to Imperial hunters. Micro-nozzle spray system generates a five meter diameter cloud that disperses charged energy beams. The cloud reduces the damage of all blaster bolts by -2D. Dependant on prevailing wind conditions, once triggered, the dissipation field remains in effect upwards of four minutes. Optional adjustment generates a continuous 30 degree forward-facing cone of dispersal, for rapid forward movement. The suit itself provides +2D physical, +1D energy protection, but also reduces *Dexterity* and related actions by -1D.

Source: Galaxy Guide 10: Bounty Hunters (page 87), Gundark's Fantastic Technology (page 48)

"Nullifier" Energy Diffusion Armor



Model: Unknown

Type: Energy diffusion armor

Scale: Character

Cost: Not available for sale

Availability: X (item is believed to be unique)

Game Notes: This ancient suit of powered armor consists of black, carapace-like plates, full cover helmet, and tactile gloves. When activated, the armor emits a powerful force field (5D to resist energy attacks; acts as cover) which is capable of nullifying nearly all energy attacks.

Source: Wretched Hives of Scum and Villainy (page 84)

Warrior's Armor



Model: Warrior's Vonduun Crab Armor

Type: Yuuzhan Vong personal armor

Scale: Character

Cost: Not available for sale

Availability: 4, X

Game Notes: Grants a +1D+1 bonus to *Strength* rolls to resist all forms of damage, but reduces the wearer's *Dexterity* score by -1D.

Source: The New Jedi Order Sourcebook (pages 21-22), d20 Core Rulebook (page 357), Ultimate Alien Anthology (pages 193)

Subaltern's Armor

Model: Subaltern's Vonduun Crab Armor

Type: Yuuzhan Vong personal armor

Scale: Character

Cost: Not available for sale

Availability: 4, X

Game Notes: Grants a +1D+2 bonus to *Strength* rolls to resist all forms of damage, but reduces the wearer's *Dexterity* score by -1D.

Source: The New Jedi Order Sourcebook (pages 21-22)

Subcommander's Armor

Model: Sub-Commander's Vonduun Crab Armor

Type: Yuuzhan Vong personal armor

Scale: Character

Cost: Not available for sale

Availability: 4, X

Game Notes: Grants a +2D bonus to *Strength* rolls to resist all forms of damage, but reduces the wearer's *Dexterity* score by -1D.

Source: The New Jedi Order Sourcebook (pages 21-22)

Commander's Armor

Model: Commander's Vonduun Crab Armor

Type: Yuuzhan Vong personal armor

Scale: Character

Cost: Not available for sale

Availability: 4, X

Game Notes: Grants a +2D+1 bonus to *Strength* rolls to resist all forms of damage, but reduces the wearer's *Dexterity* score by -2 pips.

Source: The New Jedi Order Sourcebook (pages 21-22)

Supreme Commander's Armor

Model: Supreme Commander's Vonduun Crab Armor

Type: Yuuzhan Vong personal armor

Scale: Character

Cost: Not available for sale

Availability: 4, X

Game Notes: Grants a +2D+2 bonus to *Strength* rolls to resist all forms of damage, but reduces the wearer's *Dexterity* score by -2 pips.

Source: The New Jedi Order Sourcebook (pages 21-22)

Warmaster's Armor

Model: Warmaster's Vonduun Crab Armor

Type: Yuuzhan Vong personal armor

Scale: Character

Cost: Not available for sale

Availability: 4, X

Game Notes: Grants a +3D bonus to *Strength* rolls to resist all forms of damage, but reduces the wearer's *Dexterity* score by -2 pips.

Source: The New Jedi Order Sourcebook (pages 21-22)

Dead Armor

Model: Dead Vonduun Crab Armor

Type: Yuuzhan Vong personal armor

Scale: Character

Cost: Not available for sale

Availability: 4, X

Game Notes: Apply the following modifiers to any suit of Vonduun crab armor that has died: -1 pip to the armor's bonus to *Strength* rolls made to resist damage, and -2 pips to *Dexterity*.

Source: The New Jedi Order Sourcebook (page 22)

Dark Combat Jumpsuit

Model: Dark Combat Jumpsuit

Type: Dark armor

Scale: Character

Cost: 16,500 & 1 Force Point

Availability: 4, X

Game Notes: A heavily-padded jumpsuit that incorporates Cortosis weave, a material that deactivates any lightsaber that damages the wearer. Grants +1D+2 to *Strength* rolls made to resist physical and energy damage. This armor also grants its wearer +1D to *Perception* or *Control* rolls made to resist the use of Projective and Receptive Telepathy, and increases the difficulty of Life Detection and Life Sense used against the wearer by +3.

Source: The Dark Side Sourcebook (page 61)

Dark Padded Battle Armor

Model: Dark Padded Battle Armor

Type: Dark armor

Scale: Character

Cost: 12,000 & 1 Force Point

Availability: 4, X

Game Notes: This armor provides the wearer with +2D to *Strength* rolls made to resist physical and energy damage. The armor is also imbued with Dark Side energy, granting the wearer a +1D bonus on rolls made to resist light side Force powers, or any Force power augmented by a light side Force Point.

Source: The Dark Side Sourcebook (page 61)



Dark Heavy Battle Armor

Model: Dark Heavy Battle Armor

Type: Dark armor

Scale: Character

Cost: 37,000 & 2 Force Points

Availability: 4, X

Game Notes: This heavily-plated armor conveys +3D to *Strength* rolls made to resist physical and energy damage. It is imbued with Dark Side stealth to keep the wearer hidden (+1D bonus to *Perception* or *Control* rolls made to resist the use of Projective and Receptive Telepathy, and increases the difficulty of Life Detection and Life Sense against the wearer by +3) and increases *Strength* (+2 pips to the wearer's *Strength* when making skill or attribute rolls, or when rolling melee damage).

Source: The Dark Side Sourcebook (page 61)



Orbalisk Armor



Type: Parasite armor
Scale: Character
Cost: Not for sale
Availability: 4

Game Notes: Orbalisk infestation will cover a small host in 13 days, a medium host in 17 days, and a large host in 21 days. The biochemical reaction created by the mixture of Dark Side energy and orbalisk venom can be reflected in a *Strength* increase of +1 pips for every 20% of coverage. Additionally, characters who are host to orbalisks can make natural healing rolls twice as often for every 20% of coverage (see below).

Orbalisk Coverage/Healing Rates		None	20%	40%	60%	80%	100%
Wound Level							
Wounded Once/ Twice		3 days	2 days	1 day	12 hrs	5 hrs	3 hrs
Incapacitated		14 days	7 days	4 days	2 days	1 day	6 hrs
Mortally Wounded		35 days	18 days	9 days	5 days	3 days	2 days

The armor bonus granted by orbalisks depends on the degree of coverage they have on the host.

% of Coverage	Bonus	vs. Lightsaber	Dexterity Penalty	Move Penalty
10%	+1 pip	+2 pips	-1 pip	-0
20%	+2 pips	+1D+1	-2 pips	-0
30%	+1D	+2D	-2 pips	-0
40%	+1D+1	+2D+2	-1D+1	-2
50%	+1D+2	+3D+1	-1D+1	-2
60%	+2D	+4D	-1D+1	-2
70%	+2D+1	+4D+2	-2D	-4
80%	+2D+2	+5D+1	-2D	-4
90%	+3D	+6D	-2D	-4
100%	+3D	+6D	-2D+2	-8

Source: The Dark Side Sourcebook (pages 67-68)

Powersuits

Galax Systems Powersuit

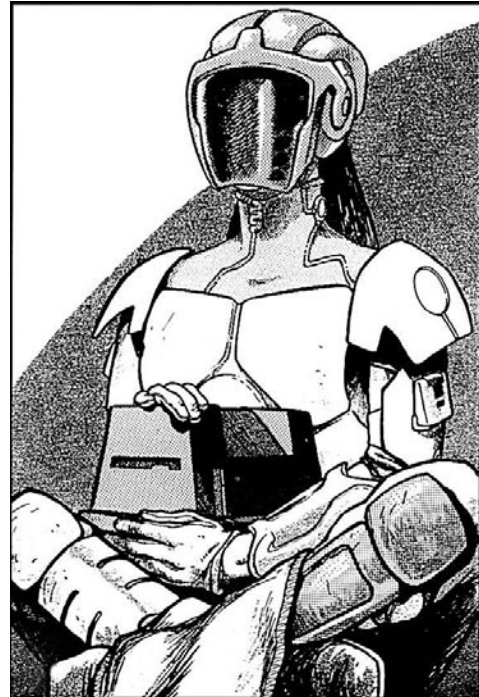

Model: Galax Systems Powersuit

Type: Powersuit

Skill: Powersuit operation

Game Notes: Adds +3D to *lifting* skill, and subtracts -1D from all *Dexterity* skills, but provides no protection from damage.

Source: Cracken's Rebel Field Guide (page 54)

Servo-Lifter

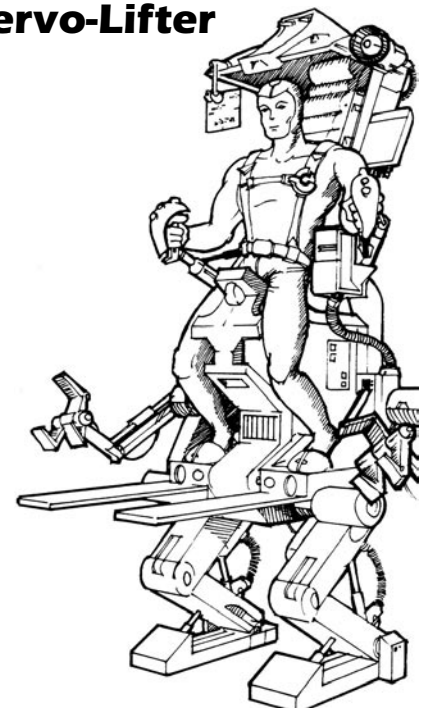

Model: Verekil Servo-Lifter V-2z
Type: Servo-enhanced exo-skeleton
Scale: Character
Length: 3 meters tall
Skill: Powersuit operation: servo-lifter
Crew: 1
Cost: 10,000 (new); 7,000 (used)
Availability: 3
Maneuverability: 1D
Move: 30; 90 kmh
Body Strength: 2D
Game Notes: Can lift up to 1.5 metric tons.
Source: Galladinium's Fantastic Technology (page 57), Platt's Smugglers Guide (page 50)

Bounty Hunter Armor



Model: Corellian PowerSuit
Type: Bounty hunter armor
Scale: Character
Skill: Powersuit operation
Cost: 2,500
Availability: 2, R
Game Notes: +2D physical, +1D energy.
Source: Rulebook (page 234)

Smasher Armor

Model: Modified Locris Syndicates personal Protection Suit
Type: Personal battle armor
Cost: 1,250
Availability: 3
Game Effects:
Basic Suit: +1D physical and energy.
Servo Enhancers: +2D to *brawling*, *climbing/jumping*, *lifting*, and damage in *Strength*-related attacks.
Source: Galaxy Guide 10: Bounty Hunters (page 87), Gundark's Fantastic Technology (page 60)

Corellian Powersuit

Model: Corellian powersuit
Type: Powersuit body armor
Scale: Character
Skill: Powersuit operation
Cost: 10,000
Availability: 2, R
Game Notes: +1D+2 physical, +1D energy, -1D *Dexterity* and related attributes. Servos in the armor provide +1D *Strength* bonus for *lifting* skill rolls and *melee* and *brawling* damage. If the wearer can't make an *Easy powersuit operation* roll, or if the armor is disabled or out of power, this bonus doesn't apply and the wearer suffers a further -1D penalty to *Strength* and *Dexterity*.
Source: d20 Core Rulebook (page 139)



Corellian HuntSuit

Model: Corellian HUNtSuit
Type: Personal battle armor
Cost: 2,900
Availability: 3, R
Game Effects:
Basic Suit: +2D physical; +1D energy for entire body; -1D to *Dexterity* and related skills.
Power Suit: +1D to *lifting* skill.
Sensor Pod: +1D to all *search* attempts made within 50 meters.
Source: Galaxy Guide 10: Bounty Hunters (page 87), Gundark's Fantastic Technology (page 51)

Charon Battle Armor



Type: Charoon battle armor suit

Scale: Character

Skill: Powersuit operation

Cost: Not available for sale

Availability: 4

Game Notes: Armor has *Dexterity* 4D+1, *dodge* 4D+2, *plasma cannon* 4D+2, *Strength* 5D, *brawling* 5D+2, *climbing/jumping* 5D+1 and *lifting* 6D. Armor can make no more than two attacks per round. Plasma cannon does 4D+1 damage, armor claws do 6D damage. Charon biosensing technology allows the battle armor to automatically acquire targets which are obscured by the environment, and to make a free 6D *search* roll against any hiding or sneaking character. Humanoids must make a Moderate *Dexterity* roll to twist into the battle armor and a Difficult *powersuit operation* roll to operate the suit. They also have +2 added to all difficulty numbers when using the suit to perform an action. A Moderate *stamina* roll must be made every 15 minutes, failure indicating exhaustion and heat prostration. Subtract 1D from all skills and attributes until the character has at least an hour's rest.

Source: Otherspace (page 29), Otherspace II (page 23)

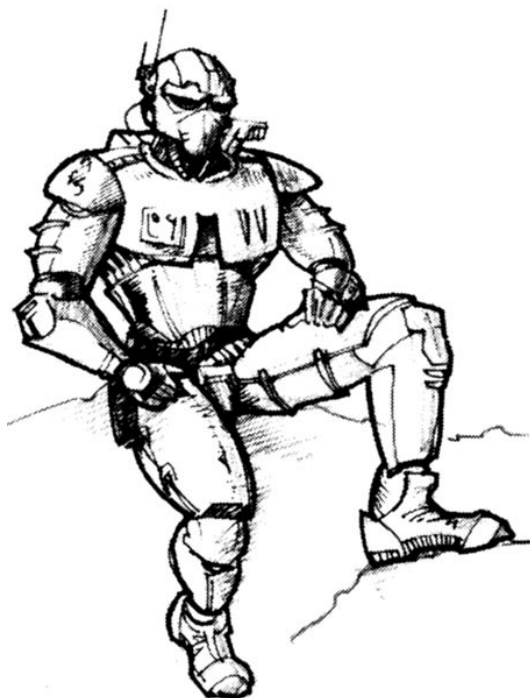

AV-1 Power Armor Damage Chart

Lightly Damaged Armor

Roll	Result
1	-1D from <i>Strength</i> enhancements
2	-5 from Move of repulsorlift engine
3	On board weapon hit and destroyed
4-6	Armor loses one pip of its effectiveness

Heavily Damaged Armor

Roll	Result
1	Power loss for 1D rounds
2-3	-2D from <i>Strength</i> enhancements
4-5	-2D to <i>Dexterity</i> and all related skills
6	Armor loses -1D of its effectiveness

Severely Damaged Armor

Roll	Result
1	Power loss for 2D rounds
2	Power overload or power generator destroyed; wearer suffers 5D damage in explosion
3	Overloaded power generator will explode in 1D rounds
4	All weapons disabled
5	Armor loses all protection bonus at location of hit (head, torso, arm, leg)
6	Armor toppled in assault, all power lost, suit non-functional

AV-1S (Scout)

Model: GTU AV-1S Armor

Type: Powersuit

Skill: Powersuit operation

Cost: 7,500

Availability: 3, F

Game Effect:

Basic Suit: +1D energy, +1D+1 physical protection, -1D *Dexterity* and all related skills.

Enhanced Strength: +1D to *Strength* for all skills, including melee and unarmed combat damage.

Repulsorlift Engine: Move of 20, flight ceiling of 100 meters. Maneuver rolls are made with the *powersuit operation* skill.

Infrared Imaging Module: Ranged up to 200 meters, allows

vision based on heat.

Starlight Imaging: Magnifies available light for excellent low-light vision (no penalties for darkness except in absolute darkness, but sudden flashes of light can cause 4D stun damage if the user does not make a Moderate *Perception* roll to close his or her eyes in time).

Power Lamp: 100 meter range.

Multi-channel Comm Unit: Includes comlink encoder, ranged up to 50 kilometers, and external amplifier.

Macrobinooculars: Standard rules as for macrobinooculars.

5 Sureseal Patches: Automatic patches against suit leaks.

Bio-Readout: Informs wearer of his/her physical condition.

Environment Scanner: Scans air for breathability and toxins and detects harmful radiation.

Game Notes: Can operate for 36 hours without replenishing supplies and takes 5 minutes to put on.

Source: Galladinium's Fantastic Technology (pages 80-81), Arms and Equipment Guide (pages 44-45)

AV-1C (Combat)

Model: GTU AV-1C Power Suit

Type: Powersuit

Skill: Powersuit operation

Cost: 12,000

Availability: 4, X

Game Effect:

Battle Suit: +2D physical and energy, -1D to *Dexterity* and all related skills.

Strength Enhancement: +2D to *Strength* and related skills, but any failed *Strength* or related roll strips the servos, causing a full malfunction of the suit for 1D rounds; also roll 1D, if the result is 1-2, the wearer suffers 4D stun damage from arcing electricity.

Repulsorlift Engine: Move of 20, flight ceiling of 100 meters. Maneuver rolls are made with the *powersuit operation* skill.

Infrared Imaging Module: Ranged up to 200 meters, allows vision based on heat.

Starlight Imaging: Magnifies available light for excellent low-light vision (no penalties for darkness except in absolute darkness, but sudden flashes of light can cause 4D stun damage if the user does not make a Moderate *Perception*

roll to close his or her eyes in time).

Power Lamp: 100 meter range.

Multi-channel Comm Unit: Includes comlink encoder, ranged up to 50 kilometers, and external amplifier.

Macrobinoculars: Standard rules as for macrobinoculars.

5 Sureseal Patches: Automatic patches against suit leaks.

Bio-Readout: Informs wearer of his/her physical condition.

WITS: Allows the wearer to link two weapons into the suit's battle computer, getting +1D to hit for each weapon.

Game Notes: Can operate for 24 hours without replenishing supplies and takes 10 minutes to put on.

Source: Galladinium's Fantastic Technology (page 81), Arms and Equipment Guide (page 44)

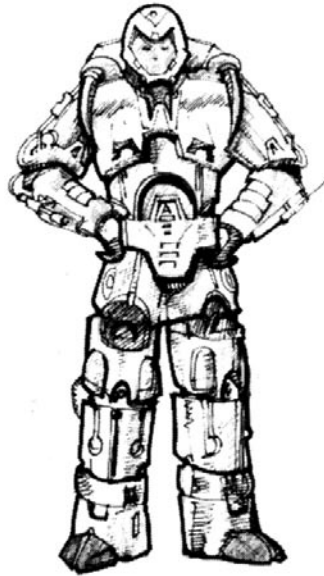

Bio-Readout: Informs wearer of his/her physical condition.

WITS: Allows the wearer to link two weapons into the suit's battle computer, getting +2D+2 to hit for each weapon.

Integrated Medpac System: Has *first aid* skill at 4D.

Rocket Ejection System: Ejects occupant if suit suffers heavy damage on a roll of 1-2 on 1D.

Game Notes: Can operate for 12 hours without replenishing supplies and takes 15 minutes to put on.

Source: Galladinium's Fantastic Technology (page 81), Arms and Equipment Guide (pages 43-44)

Telgorn Corp. Mark II Powersuit

Model: Telgorn Corp. Mark II Powersuit

Type: High pressure power armor

Scale: Character

Skill: Powersuit operation: Mark VI

Crew: 1

Cover: Full

Cargo Capacity: 10 kilograms

Consumables: 2 days

Cost: 30,000

Availability: 2, F

Maneuverability: 1D

Atmosphere: 21; 60 kmh

Body: 4D

Weapons:

Cutting Laser

Fire arc: Front or right (mounted on arm)

Skill: Vehicle blasters

Fire Control: 2D

Range: 1 meter

Damage: 4D

Source: Supernova (page 78)

AV-1A (Assault)

Model: GTU AV-1A Power Suit

Type: Powersuit

Skill: Powersuit operation

Cost: 50,000

Availability: 4, X

Game Effect:

Battle Suit: Provides +2D+2 physical and energy, -2D to *Dexterity* and all related skills.

Strength Enhancement: +3D to *Strength* and related skills, but any failed *Strength* or related roll strips the servos, causing a full malfunction of the suit for 1D rounds; also roll 1D, if the result is 1-2, the wearer suffers 4D stun damage from arcing electricity.

Repulsorlift Engine: Move of 20, flight ceiling of 100 meters. Maneuver rolls are made with the *powersuit operation* skill.

Infrared Imaging Module: Ranged up to 200 meters, allows vision based on heat.

Starlight Imaging: Magnifies available light for excellent low-light vision (no penalties for darkness except in absolute darkness, but sudden flashes of light can cause 4D stun damage if the user does not make a Moderate *Perception* roll to close his or her eyes in time).

Power Lamp: 100 meter range.

Multi-channel Comm Unit: Includes comlink encoder, ranged up to 50 kilometers, and external amplifier.

Macrobinoculars: Standard rules as for macrobinoculars.

5 Sureseal Patches: Automatic patches against suit leaks.

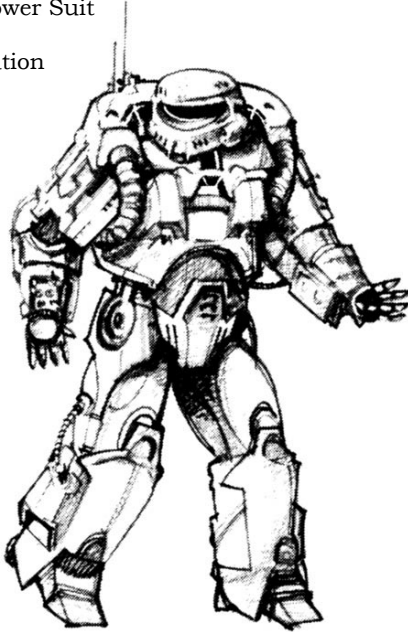

Telgorn Corp. Mark III Powersuit

Model: Telgorn Corp. Mark III Powersuit

Type: High pressure power armor

Scale: Character

Skill: Powersuit operation: Mark VI

Crew: 1

Cover: Full

Cargo Capacity: 10 kilograms

Consumables: 2 days

Cost: 30,000

Availability: 2, F

Maneuverability: 1D

Atmosphere: 21; 60 kmh

Body: 5D

Weapons:

Blaster Cannon

Fire arc: Front

Skill: Vehicle blasters

Fire Control: 1D

Range: 3-25/50/100

Damage: 5D

Mini-Proton Torpedoes

Fire arc: Front

Skill: Missile weapons

Fire Control: 1D

Range: 3-5/10/20

Damage: 6D

Source: Supernova (page 78)

Telgorn Corp. Mark IV Powersuit

Model: Telgorn Corp. Mark IV Powersuit

Type: High pressure power armor

Scale: Character

Skill: Powersuit operation: Mark VI

Crew: 1

Cover: Full

Cargo Capacity: 10 kilograms

Consumables: 2 days

Cost: 30,000

Availability: 2, F

Maneuverability: 1D

Atmosphere: 25; 70 kmh

Body: 6D

Weapons:

Laser Cannon

Fire arc: Front

Skill: Vehicle blasters

Fire Control: 1D

Range: 3-20/40/80

Damage: 4D

Game Notes: This rapid escape version is built for speed and easy access. It is one difficulty easier to get this powersuit going rapidly.

Source: Supernova (page 78)

Telgorn Corp. Mark V Powersuit

Model: Telgorn Corp. Mark V Powersuit

Type: High pressure power armor

Scale: Character

Skill: Powersuit operation: Mark VI

Crew: 1

Cover: Full

Cargo Capacity: 10 kilograms

Consumables: 2 days

Cost: 30,000

Availability: 2, F

Maneuverability: 1D

Atmosphere: 28; 80 kmh

Body: 4D

Weapons:

Laser Cannon

Fire arc: Front

Skill: Vehicle blasters

Fire Control: 1D

Range: 3-20/40/80

Damage: 4D

Game Notes: This repair model has a plethora of tools, making it the ideal choice for any maintenance function.

Source: Supernova (page 78)

Telgorn Corp. Mark VI Powersuit

Model: Telgorn Corp. Mark VI Powersuit

Type: High pressure power armor

Scale: Character

Skill: Powersuit operation: Mark VI

Crew: 1

Cover: Full

Cargo Capacity: 10 kilograms

Consumables: 2 days

Cost: 30,000

Availability: 2, F

Maneuverability: 1D

Atmosphere: 35; 100 kmh

Body: 6D

Weapons:

Blaster Cannon

Fire arc: Front or right (mounted on arm)

Skill: Vehicle blasters

Fire Control: 2D

Range: 3-25/50/100

Damage: 6D

Source: Supernova (pages 74-75)

Malgon Armor

Model: Modified X5 Malgon Armor

Type: Light power armor

Skill: Powersuit operation

Cost: Not available for sale

Availability: 4, X

Game Notes:

Armor: Provides +2D to *Strength* for physical attacks, +2D for energy attacks; -2D to *Dexterity* and related skills. Covers head, torso, arms and legs.

Heaviness: Due to the suit's weight, the skills *hide*, *sneak* and *swimming* cannot be used while wearing this armor.

Strength: Servos in the arms and torso provide a +1D *Strength* bonus for *lifting* and melee and brawling damage.

Sensors: The helmet is equipped with a sensor pod which provides a +1D bonus to *search*.

Flame Projectors: 5D damage, uses *armor weapons* skill, creates a cone one meter wide, variable one to five meters long. One projector is mounted on each arm.

Source: Gundark's Fantastic Technology (pages 57-58)

Nemesis Armor

Model: Mili-Corp DZ 17X Nemesis

Type: Medium power armor

Skill: Powersuit operation

Cost: Not available for sale

Availability: 4, X

Game Notes:

Armor: Provides +3D to *Strength* for physical attacks, +2D to energy attacks; -2D to *Dexterity* and related skills. Covers head, torso, arms and legs.

Heaviness: Due to this suit's weight, the skills *hide*, *sneak* and *swimming* cannot be used while wearing this armor.

Strength: Servos in the armor provide a +1D *Strength* bonus for *lifting* skill rolls and melee and brawling damage.

Speed: Due to the bulk of the armor, the wearer's *Speed* is reduced to 7.

Sensors: Provides 180-degree vision, macrobinocular vision and mini-targeting computer. Provides +2D to *Perception* and *search* rolls. Contains a multi-frequency targeting and acquisition system (MFTAS) which gives +1D to all ranged weapons skill rolls against targets at medium and long ranges.

DEMP Gun: 3D ionization damage, uses *armor weapons* skill, ranges: 3-4/8/12, mounted on left forearm armor.

Light Repeating Blaster: 6D damage, uses *armor weapons* skill, ranges: 3-50/120/300, mounted on right forearm armor.

Body Glove: A climate-controlled body glove incorporates additional heating and cooling elements to allow comfortable operation in moderately hot and extremely cold climates.

Source: Gundark's Fantastic Technology (pages 58-59)

Krail 210 Personal Armor

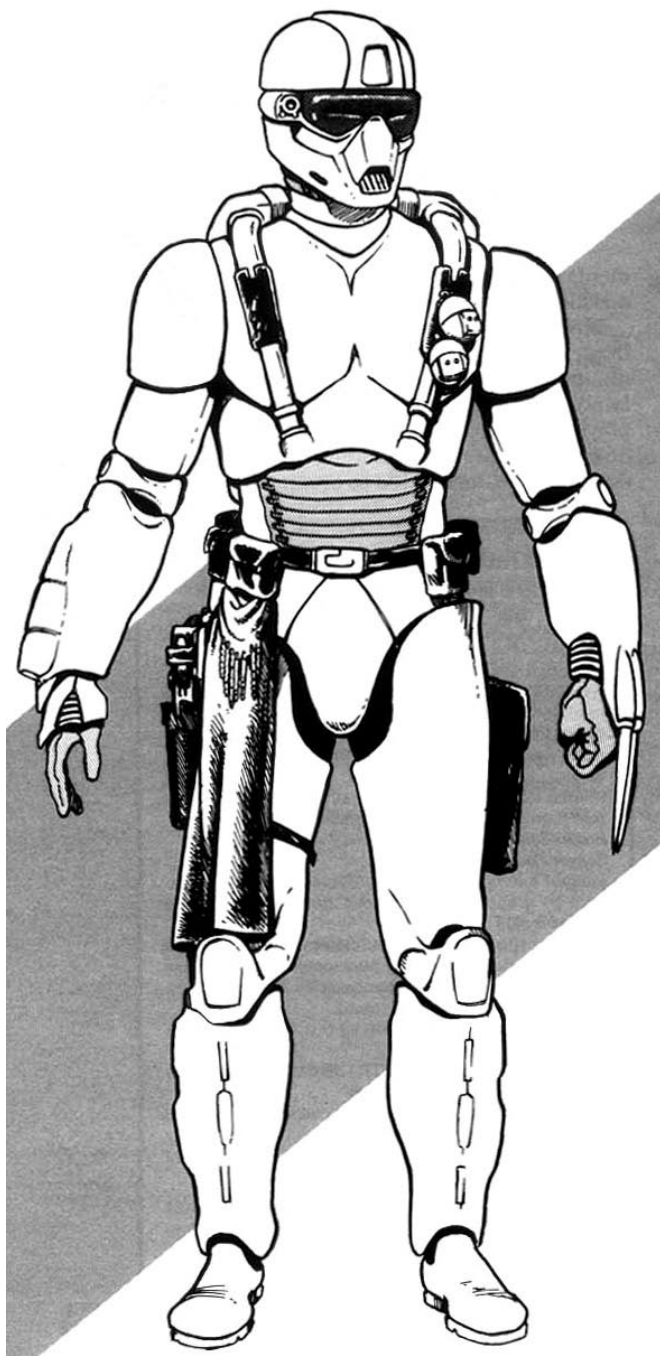

Model: Modified Krail Armory Model 210 Personal Armor
Type: Modified personal battle armor
Skill: Powersuit operation: Krail 210 armor
Cost: (with all modifications) 26,000
Availability: Basic suit is "X" on most planets; modified suit is unique
Game Effect:
Basic Suit: +2D to *Strength* for energy attacks, +3D to physical attacks; -1D to *Dexterity* and related skills. Suit has a Move of 16, with movement rolled on *powersuit operation* skill
Power Suit: +1D to *lifting*.
Sensor Pod: +1D to *search*.
Integral Internal Line Slinger: 20-meter range. Can attach to grappling or magnetic hooks. Uses *missile weapons* skill.

Jet Pack: Has a Move of 100 meters horizontally, 70 meters vertically. Uses *jet pack operation* skill, base difficulty is Ease, modified by obstacles. Has 20 charges, can expend up to two per round.

Winch: Capable of lifting 100 kg

Internal Dual Force Blades: STR+3D damage, Moderate *melee combat* difficulty.

Sealed Enviro Filter: Filter system can block out harmful molecules, or in case of insufficient or deadly atmosphere, the suit can completely seal, drawing upon a two-hour internal supply of oxygen.

Source: Galaxy Guide 9: Fragments from the Rim (page 31)

Dragon Armor

Model: SoroSuub NLZ5-11 Dragon

Type: Medium power armor

Skill: Powersuit operation

Cost: Not available for sale

Availability: 4, X

Game Notes:

Armor: +3D to *Strength* for physical attacks, +2D for energy attacks, -2D to *Dexterity* and all related skills. Covers head, torso, arms and legs.

Heaviness: Due to this suit's weight, the skills *hide*, *sneak* and *swimming* cannot be used while wearing armor.

Strength: Servos in the armor provide +1D *Strength* bonus for *lifting* skill rolls and *melee* and *brawling* damage.

Speed: Due to the bulk of the armor, the wearer's *Speed* is reduced to 7.

Sensors: Provides 180-degree vision, macrobinocular vision and mini-targeting computer. Provides +2D to *Perception* and *search* rolls. Contains a multi-frequency targeting and acquisition system (MFTAS) which gives +1D to all ranged weapons skill rolls for targeting at medium and long ranges.

Body Glove: A climate-controlled body glove incorporates additional heating elements to allow comfortable operation in moderately hot and extremely cold climates.

Defensive Blaster: 3D damage, uses *armor weapons* skill, ranges: 3-4/8/12, mounted alongside helmet.

Twin Flamers: 5D damage (fire-linked), used *armor weapons* skill, creates cone one meter wide, variable one to five meters long, mounted on left forearm armor.

Mini-Missile Launcher: 5D damage, uses *missile weapons* skill, ranges: 3-40/120/400, mounted on shoulder armor.

Sealed Enviro-Filter: Filter system can block out harmful molecules, or the suit can completely seal, drawing upon a two-hour internal supply of oxygen.

Source: Gundark's Fantastic Technology (pages 52-53)



Sunder 9

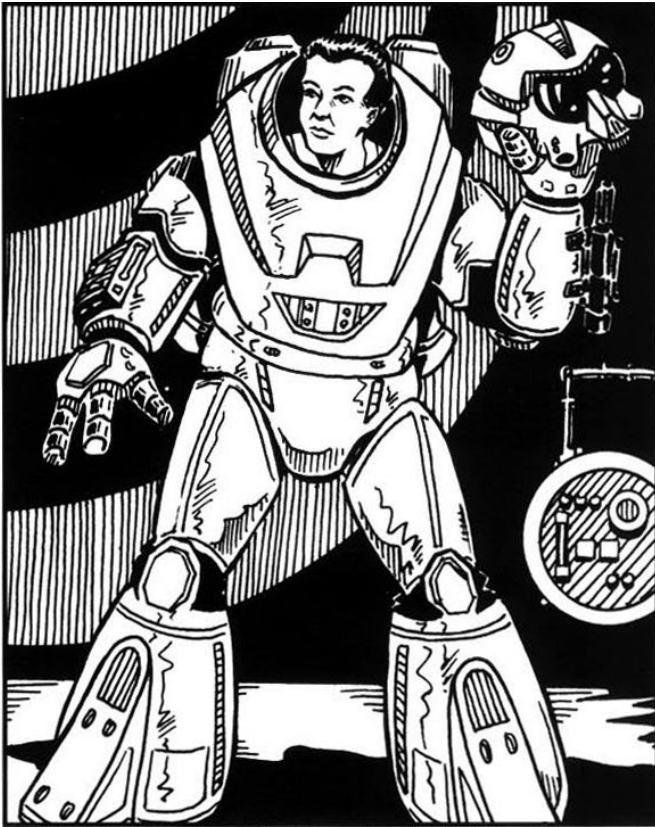

Model: Llalik Designs Sunder 9 Armor Prototype (Incomplete)

Type: Multi-environmental personal battlesuit

Skill: Powersuit operation: Sunder 9

Cost: Not available for sale

Availability: 4, X

Game Effects:

Armor: Provides +3D to *Strength* for physical attacks, +2D for energy attacks, -1D+2 to *Dexterity* and related skills. Full cover.

Strength: Servos in the upper portion of the armor add +1D+2 to *Strength* for *lifting*, *brawling* and *melee* damage.

Blaster Cannon: Cannon on left arm (usually right, but Dr. Llalik is left-handed). 6D damage, uses *blaster* skill, ranges 10-50/100/500

Flame Projector: 5D damage, uses *armor weapons* skill, projects up to three meters. Right arm.

Rocket Pack: Has *Move* of 90 meters horizontally, 50 meters vertically. Uses *rocket pack operation* skill, base difficulty is Easy, modified by terrain conditions. Has 12 charges, can expend up to three per round.

Sensors: Provides 270 degree vision and macrobinocular vision. Gives wearer +1D to *Perception* rolls, +2D to *search*. Includes specialized sonar and infrared sensor packages for dark environment or aquatic depths where light is not available.

Aquatic Propulsion System: Increases *swimming* skill by +2D; gives wearer and underwater *Move* of 14.

Body Glove: A climate-controlled body glove provides heating and cooling systems to allow operation in extreme environments.

Sealed Enviro-Filters: System prevents entry of foreign substances, can also be sealed completely when in hostile environments or during submersion. Has four hours of

power and 6 hours of oxygen.

Source: Alliance Intelligence Reports (page 88), Gundark's Fantastic Technology (page 61)

Hutt Battle Armor



Model: Hutt Battle Armor

Type: Ancient Hutt powersuit

Scale: Character

Skill: Powersuit operation

Cost: Not available for sale

Availability: 4, X

Game Notes:

Basic Suit: Overlapping plates provide +3D+2 against physical attacks, +2D+1 against energy, -2D to *Dexterity* and related skills.

Microrepulsors: Allow silent movement (+1D to *sneak*) at an enhanced *Move* of 12.

Servos: Increase wearer's *Strength* by +1D+1 and *Dexterity* by +2.

Camouflage: Plates are capable of changing color to match the surroundings, providing +1D to *hide*.

Helmet Sensors: Allow user to see in the dark for 50 meters and grant a +1D bonus to *search*.

Onboard Computer: Includes a datapad and comlink, and is capable of acting as a translator unit with *languages* 10D.

2 Built-In Hold-Out Blasters: Mounted on each arm (3D damage).

E-Web Repeating Blaster: Mounted onto right shoulder (8D damage).

Source: Tempest Feud (page 128), Ultimate Alien Anthology (page 75)

Juggernaut Armor

Model: Cozzell Juggernaut 510 Combat Power Armor

Type: Assault power armor

Skill: Powersuit operation

Cost: Not available for sale

Availability: 4, X

Game Notes:

Armor: Provides +3D to *Strength* for physical attacks, +3D to energy attacks; -3D to *Dexterity* and related skills. Covers head, torso, arms and legs.

Heaviness: Due to this suit's weight, the skills *hide*, *sneak* and *swimming* cannot be used while wearing this armor.

Strength: Servos in the armor provide +3D *Strength* bonus for *lifting* skill rolls and *melee* and *brawling* damage.

Speed: Due to the bulk of the armor, the wearer's Speed is reduced to 5.

Sensors: Provides 180-degree vision, macrobinocular vision and mini-targeting computer. Provides +2D to *Perception* and *search* rolls. Contains a multi-frequency targeting and acquisition system (MFTAS) which gives +1D to all ranged weapons skill rolls at medium and long ranges.

Body Glove: A climate-controlled body glove incorporates additional heating and cooling elements to allow comfortable operation in moderately hot and extremely cold climates.

Medium Repeating Blaster: 7D damage, uses *armor weapons* skill, ranges: 3-50/120/300, hand held with braces and targeting computer interface along right forearm armor.

Grenade Launcher: 5D damage, uses *missile weapons* skill, ranges: 1-250/350/500, mounted on left shoulder.

Retractable Claws: STR+2D damage, mounted in left gauntlet.

Source: Gundark's Fantastic Technology (pages 55-56)



Mini-Torpedo Launcher: 5D damage, uses *missile weapons* skill, ranges: 3-10/120/350, mounted in shoulder armor.

Source: Gundark's Fantastic Technology (pages 55-56)

Leviathan Armor

Model: Mon Calamari Leviathan Armor

Type: Assault power armor

Skill: Powersuit operation

Cost: Not available for sale

Availability: 4, X

Game Notes:

Armor: Provides +3D to *Strength* for physical attacks, +3D to energy attacks; -1D to *Dexterity* and related skills underwater, -3D to *Dexterity* and related skills on land. Covers head, torso, arms and legs.

Customized: If worn by someone other than its owner add an additional -1D to the *Dexterity* penalty.

Heaviness: Due to this suit's weight, the skills *hide*, *sneak* and *running* cannot be used while wearing it on land.

Strength: Servos in the armor provide +3D *Strength* bonus for *lifting* skill rolls and melee and brawling damage.

Speed: Due to the bulk of the armor, the wearer's Speed is reduced to 5 while on land. Special underwater propulsion units in leg armor gives the wearer a Speed of 15 while swimming underwater.

Sensors: Provides 180-degree vision, macrobinocular vision and mini-targeting computer. Provides +2D to *Perception* and *search* rolls. Contains a multi-frequency targeting and acquisition system (MFTAS) which gives +1D to all ranged weapons skill rolls against targets at medium and long ranges. The targeting system also allows torpedoes to lock on and adjust course to follow moving targets. Includes special sonar gear. Thus this armor is designed to deal with deep waters where light is absent.

Body Glove: A climate-controlled body glove incorporates additional heating and cooling elements to allow comfortable operation in moderately hot and extremely cold climates.

Duo-Flechette Rifle: 5D damage, uses *armor weapons* skill, ranges: 3-10/30/60, mounted on right forearm armor.

Military Unit Armor

Espo Armor

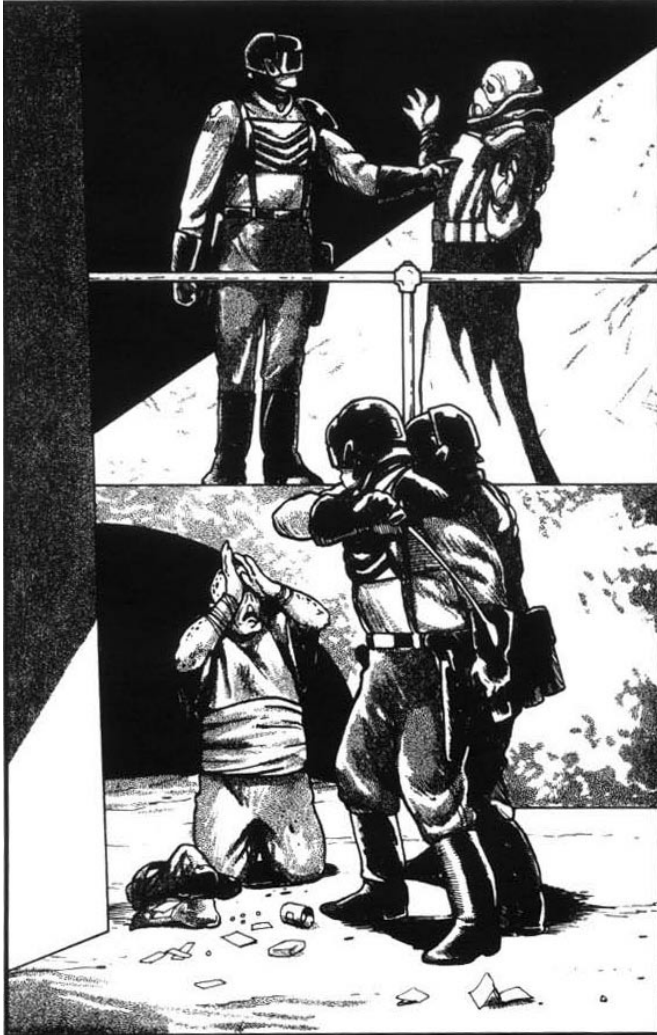

Model: Ayelixe/Krongbing Textiles blast vest and blast helmet

Type: Personal armor

Scale: Character

Cost: 200 (vest), 200 (helmet)

Availability: Not for sale

Game Notes: Blast helmet (+1 energy, +1D physical), blast vest (+1 energy, +1D physical, -1 *Dexterity* and related skills).

Source: Gundark's Fantastic Technology (pages 53-54), Han Solo and the Corporate Sector Sourcebook (pages 116-117)

Espo Riot Armor

Model: Authority Riot Armor

Type: Blast armor

Cost: Not available for sale

Availability: X

Game Notes: Helmet: blast helmet with visor +1D from all energy attacks, +2D from all physical attacks; all other areas: +2 from energy attacks, +1D+2 from physical attacks,



Jedi Battle Armor

Model: Jedi Battle Armor

Type: Personal armor

Scale: Character

Cost: 6,000

Availability: 4, X

Game Notes: Jedi battle armor adds +2D to all *Strength* rolls made by the wearer to resist all forms of damage, but subtracts 1D+1 from the wearer's *Dexterity* score and -2 from his *Move* score due to its bulk.

Source: Power of the Jedi Sourcebook (pages 55-56)



-2 from *Dexterity* and all *Dexterity*-related actions.

Source: Gundark's Fantastic Technology (page 54), Han Solo and the Corporate Sector Sourcebook (page 117)

Rodian Protector Armor



Model: Chattza Protector Armor
Type: Rodian personal battle armor
Scale: Character
Cost: Not for sale
Availability: 3, X (on Rodia)
Game Notes: +2D physical, +1D energy for entire body, -1D to all *Dexterity* related skills.
Source: Shadows of the Empire Planets Guide (page 12)

Iotran Braceman Armor



Model: Standard Iotran Braceman Armor
Type: Braceman armor
Scale: Character
Cost: 8,000
Availability: 4, X
Game Notes:
Basic Suit: +2D physical, +1D energy, -1D to *Dexterity* and related skills.
Sensor System: Built into the helmet, provides a +1 bonus to attack rolls made with the armor's built-in weapons.
Retractable Blade: Concealed in the right gauntlet. Does STR+1D (max: 6D) damage.
Tangler Gun: Shoots a triple strand of durawire weighed at each end of the threads that entangles its target with a *Strength* of 5D (range: 3-8/20/60; ammo: 5; arm-mounted).
Mini Flechette Gun: Releases a spray of needles that deal 2D+2 damage. If the weapon deals damage, target must make a *Difficult stamina* roll or suffer a -1D *Dexterity* penalty (range: 3-10/30/120; ammo: 10; arm-mounted).
Source: Ultimate Alien Anthology (page 77)

Goroth Planetary Police Armor

Model: Goroth Planetary Police Armor
Type: Specialized personal defense armor
Cost: Not available for sale
Availability: 3, X
Game Notes:
Basic Suit: +2D physical, +1D+1 energy to *Strength* to resist damage. -1D to all *Dexterity* attribute and skill checks. Sealed environment with 10 hours of air supply.
Heating/Cooling Unit: Keeps the wearer comfortable in ambient temperatures ranging from -75° to 170° C.
Comlink: Helmet contains tongue-toggled comlink for instant communication with other units.
Targeting System: Contains a Multi-Frequency targeting and Acquisition System (MTAS) which gives +2D to all *Perception* checks in darkness, smoke and other visibility-obscuring conditions. Also gives +2D to ranged weapon skill used (such as *blaster*) when the user aims for more than one round (in addition to the normal bonus for "preparing", as described in the Rulebook).
Emergency Survival Kit: Incorporated into backpack, including two additional dylinium hydride power packs which last 12 hours (8 hours in extreme temperatures).
Dedicated Emergency Locator: 150 kilometer range.
Source: Goroth, Slave of the Empire (pages 86-87)

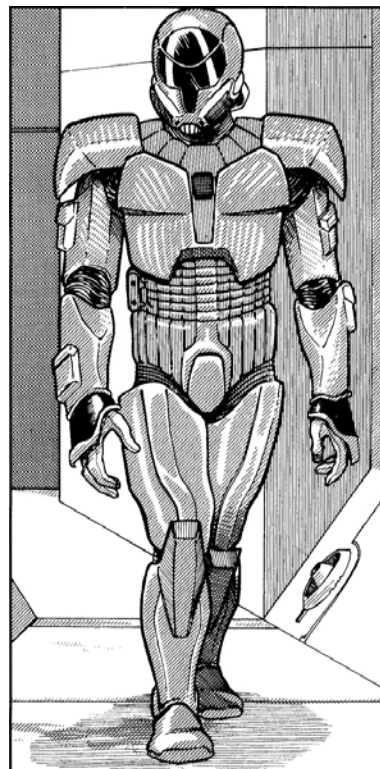

Clone Trooper Armor, Mark I



Model: Republic Clone Trooper Armor, Mark I

Type: Military armor

Scale: Character

Cost: Not available for sale

Availability: 3, X

Game Notes:

Armor Protection: +2D physical, +1D energy, -1D *Dexterity* and related skills.

Comlink: Tongue-activated helmet comlink.

Body Glove: Climate controlled body glove allows operation in uncomfortably cold or warm climates.

MFTAS: Multi-Frequency Targeting Acquisition System; adds +1 to *Perception* checks in low-visibility situations, +1 to ranged weapon skill uses against targets moving more than 10 meters per round; polarized lenses prevent flash-blinding.

Utility Belt: High-tension wire, grappling hooks, spare blaster power packs, ion flares, concentrated rations, spare comlink, water packs, 2 medpacs.

Clone SCUBA Trooper Armor

Model: Republic Aquatic Assault Trooper Armor

Type: Underwater military armor

Scale: Character

Cost: Not available for sale

Availability: 3, X

Game Notes:

Armor Protection: +1D physical and energy, +2D *swimming* skill.

Comlink: Tongue-activated helmet comlink.

Sealed Body Glove: Climate controlled body glove allows operation in uncomfortably cold or warm climates. Miniaturized scrubbers built into the breathing unit are able to extract oxygen from water environments, and allow for attachment of oxygen tanks.

Aquatic Propulsion Pack: Has an underwater Move of 20. Maneuverability jets incorporated into the shin guards add an extra +1D to *swimming*.

MFTAS: Multi-Frequency Targeting Acquisition System;

adds +1D to *Perception* checks in low-visibility situations, +1D to ranged weapon skill uses against targets moving more than 10 meters per round; polarized lenses prevent flash-blinding.

Utility Belt: High-tension wire, grappling hooks, spare blaster power packs, ion flares, concentrated rations, spare comlink, water packs, 2 medpacs, spare breather.

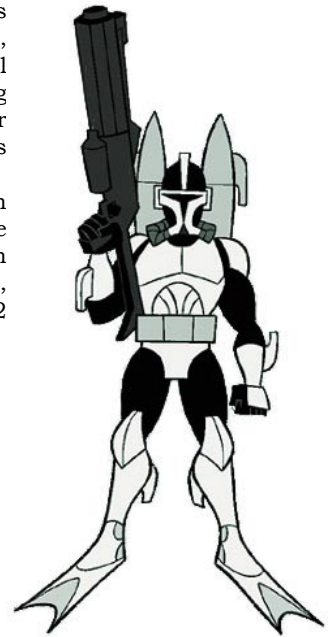

ARC Trooper Armor



Model: Republic Advanced Recon Commando Armor

Type: Military armor

Scale: Character

Cost: Not available for sale

Availability: 4, X

Game Notes:

Armor Protection: +1D physical and energy.

Comlink: Tongue-activated helmet comlink.

Body Glove: Climate controlled body glove allows operation in uncomfortably cold or warm climates.

MFTAS: Multi-Frequency Targeting Acquisition System; adds +1D to *search* checks, +1D to ranged weapon skill uses against targets moving more than 10 meters per round; polarized lenses prevent flash-blinding.

Utility Belt: High-tension wire, grappling hooks, spare blaster power packs, ion flares, concentrated rations, spare comlink, water packs, 2 medpacs.

Source: Geonosis and the Outer Rim Worlds (pages 80-81)

Katarn Armor



Model: Katarn-class Republic Commando Body Armor

Type: Commando armor

Scale: Character

Cost: Not available for sale

Availability: 4, X

Game Notes:

Armor Protection: +2D physical and energy, -1D *Dexterity* and related skills.

Comlink: Tongue-activated helmet comlink.

Retractable Vibroblade: Concealed in right gauntlet, does STR+1D+2 damage, uses *melee combat* skill. May be set to automatically spring out every time the user punches something, in which case it uses the *brawling* skill.

Sealed Body Glove: Climate controlled body glove and breath filter allows operation in uncomfortably cold or warm climates and limited protection in toxic-air environments. Sealed suit allows up to five minutes exposure to the vacuum of space.

Auto-Bacta Injectors: When the wearer suffers a Wounded or worse injury, the system automatically injects bacta on the affected area. This does not actually heal the wound, but reduces the injury penalty by 1D (and keeps an Incapacitated character awake, as if he was only Wounded Twice). Unit has a single charge; multiple bacta injections grant no further benefits.

MFTAS: Multi-Frequency Targeting Acquisition System; adds +2D to *Perception* and *search* checks in low-visibility situations, +1D to ranged weapon skill uses against targets moving more than 10 meters per round; polarized lenses prevent flash-blinding.

Viewplate: Macrobinocular imaging set (50-100/200/500 meters range) with UV nightvision (See MFTAS, above).

Utility Belt: High-tension wire, grappling hooks, spare blaster power packs, ion flares, concentrated rations, spare comlink, water packs, 2 medpacs, additional supplies pouches.

Clone Trooper Armor, Mark II



Model: Republic Clone Trooper Armor, Mark II

Type: Military armor

Scale: Character

Cost: Not available for sale

Availability: 3, X

Game Notes:

Armor Protection: +2D physical, +1D energy, -1D *Dexterity* and related skills.

Comlink: Tongue-activated helmet comlink.

Sealed Body Glove: Climate controlled body glove and breath mask allows operation in uncomfortably cold or warm climates and toxic-air environments.

MFTAS: Multi-Frequency Targeting Acquisition System; adds +1D to *Perception* checks in low-visibility situations, +1D to ranged weapon skill uses against targets moving more than 10 meters per round; polarized lenses prevent flash-blinding.

Utility Belt: High-tension wire, grappling hooks, spare blaster power packs, ion flares, concentrated rations, spare comlink, water packs, 2 medpacs.

Royal Guard Armor

Model: Standard Royal Guard Armor

Type: Military armor

Scale: Character

Cost: Not available for sale

Availability: 3, X

Game Notes:

Armor Protection: +2D physical, +1D energy, -1D *Dexterity* and related skills.

Comlink: Tongue-activated top-security scrambler helmet comlink.

Sealed Body Glove: Climate controlled body glove and breath mask allows operation in extremely cold or warm climates and toxic-air environments.

MFTAS: Multi-Frequency Targeting Acquisition System; adds +3D to *Perception* and *search* checks in low-visibility situations, +2D to ranged weapon skill uses against targets moving more than 10 meters per round; polarized lenses prevent flash-blinding.



Utility Belt: High-tension wire, grappling hooks, spare blaster power packs, ion flares, concentrated rations, spare comlink, water packs, 2 medpacs.

Source: Rules of Engagement – The Rebel SpecForce Handbook (page 103), Galaxy Guide 5: Return of the Jedi (page 46)

Coruscant Guard Armor



Model: Standard Coruscant Guard Armor

Type: Personal battle armor

Scale: Character

Cost: Not available for sale

Availability: X

Game Notes:

Basic Suit: Provides +2D physical, +1D energy, -1D *Dexterity* and related skills.

Optic Sensors: Allows user to operate in complete darkness

with no penalty.

Filter: Self-sealing filter system screens out all dangerous particulates. Unlike stormtrooper armor, this armor lacks an oxygen supply; there must be a potentially breathable (but polluted) atmosphere to filter or the user will suffocate.

Comlink Scrambler: Comlink is linked to other Coruscant Guard units and Coruscant Guard command, allowing units to disperse yet still be in full communication. Optional tracking beacon software adds a tracking beacon to that unit commander knows positions of other troops at all times; unit commander's helmet has verbally activated internal "heads-up display" to show trooper positions.

Climate Control Body Glove: Allows user to operate comfortably in exceptionally hot or cold climates for periods of up to several hours.

Source: Shadows of the Empire Sourcebook (page 113), Rules of Engagement – The Rebel SpecForce Handbook (pages 102-103)

Imperial Sentinel Armor



Type: Special guard armor

Scale: Character

Cost: Not available for sale

Availability: X

Game Notes: +2D physical, +1D energy, -1D to *Dexterity* and all related skills.

Source: Dark Empire Sourcebook (page 71)

Imperial Dungeoneer Armor

Type: Dungeoneer armor

Scale: Character

Cost: Not available for sale

Availability: X

Game Notes: Light duty (+1D to all attacks, breath filters) or heavy duty (+3D to physical, +2D to energy, internal comlink with life function information and continuous broadcast of audio and video pickups, motion sensor with 10 meter range (+1D to *search*), independent air supply).



Both armor types feature a unique buckle feature on the armor fasteners, requiring an electronic key to remove the armor.

Source: Dark Empire Sourcebook (pages 41-42)

Imperial Sovereign Protector Armor



Type: Military bodyguard armor
Scale: Character
Cost: Not available for sale
Availability: X
Game Notes: +3D physical, +2D energy, sensor suite adds +1D to *search* or *Perception*.
Source: Dark Empire Sourcebook (page 70)

Imperial Field Armor



Type: Army field armor
Scale: Character
Cost: Not available for sale
Availability: X
Game Notes: +1D physical and energy.
Source: Galaxy Guide 3: The Empire Strikes Back (page 40)

Imperial Gunner Armor

Type: Gunner armor
Scale: Character
Cost: Not available for sale
Availability: X
Game Notes: +1D physical, +2 energy, targeting computer linkup helmet (+2D to *capital ship gunnery*)
Source: Galaxy Guide 1: A New Hope (page 55)



CompForce Trooper Armor

Model: Standard CompForce Trooper Armor
Type: Combat armor
Scale: Character
Cost: Not available for sale
Availability: 4, X
Game Notes: +2 energy, +1D physical.
Source: Rules of Engagement – The Rebel SpecForce Handbook (pages 96-97)

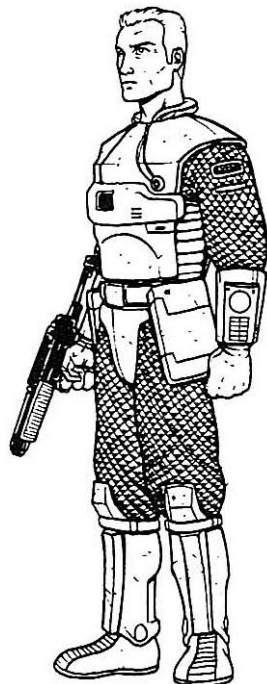

Stormtrooper Armor



Model: Standard Stormtrooper Armor

Type: Military armor

Scale: Character

Cost: Not available for sale

Availability: 3, X

Game Notes:

Armor Protection: +2D physical, +1D energy, -1D *Dexterity* and related skills.

Comlink: Tongue-activated helmet comlink.

Sealed Body Glove: Climate controlled body glove and breath mask allows operation in uncomfortably cold or warm climates and toxic-air environments.

MFTAS: Multi-Frequency Targeting Acquisition System; adds +2D to *Perception* checks in low-visibility situations, +2D to ranged weapon skill uses against targets moving more than 10 meters per round; polarized lenses prevent flash-blinding.

Utility Belt: High-tension wire, grappling hooks, spare blaster power packs, ion flares, concentrated rations, spare comlink, water packs, 2 medpacs.

Source: Rulebook (page 234), Imperial Sourcebook (page 46), Rules of Engagement – The Rebel SpecForce Handbook (pages 97-99), The Far Orbit Project (page 143)

Sandtrooper Armor

Model: Standard Desert Assault Trooper Armor

Type: Hot terrain military armor

Scale: Character

Cost: Not available for sale

Availability: 3, X

Game Notes:

Armor Protection: +1D physical and energy, -1D *Dexterity* and related skills.

Long-Range Comlink: Tongue-activated helmet comlink, surface to orbit range.

Sealed Body Glove: Climate controlled body glove and breath mask allows operation in extremely hot climates and toxic-air environments.

Body glove is supplemented with backpack cooling/moisture exchange unit. *MFTAS:* Multi-Frequency Targeting Acquisition System; adds +2D to *Perception* checks in low-visibility situations, +2D to ranged weapon skill uses against targets moving more than 10 meters per round; polarized lenses prevent flash-blinding.

Utility Belt: High-tension wire, grappling hooks, spare blaster power packs, ion flares, concentrated rations, spare comlink, water packs, 2 medpacs, and coolant tent.

Source: Rules of Engagement – The Rebel SpecForce Handbook (pages 99-100), Galaxy Guide 1: A New Hope (pages 19-20)



AT-AT Operator Armor



Type: Imperial walker operator armor
Scale: Character
Cost: Not available for sale
Availability: X
Game Notes: +1D physical and energy, -2 to *Dexterity* and all related skills, internal comlink.
Source: Galaxy Guide 3: The Empire Strikes Back (page 38), Star Wars Trilogy Sourcebook SE (page 51)

Imperial Pilot Flight Suit

Model: Standard Imperial Flight Suit
Type: Armored military flight suit
Scale: Character
Cost: Not available for sale
Availability: 3, X
Game Notes:
Flight Suit: Provides +2 to *Strength* to resist damage and additional protection against vacuum for limited periods. It grants a +1D+1 bonus to *stamina* to resist cold temperatures.
Helmet: Contains an internal comlink and navigation computer linkup (+1D to sensors).
Utility Belt: Ion flares, one week concentrated rations, spare comlink, water packs, 1 medpac.
Source: The Movie Trilogy Sourcebook (page 52), d20 Core Rulebook (page 138)



Scout Trooper Armor

Model: Stormtrooper Scout Armor
Type: Military scout armor
Scale: Character
Cost: Not available for sale
Availability: 3, X
Game Notes:
Armor Protection: +2 physical and energy.
Comlink: Tongue-activated helmet comlink.
Sealed Body Glove: Climate controlled body glove and breath mask allows operation in uncomfortably cold or warm climates and toxic-air environments.
MFTAS: Multi-Frequency Targeting Acquisition System; adds +2D to *Perception* checks in low-visibility situations, +2D to ranged weapon skill uses against targets moving more than 10 meters per round; polarized lenses prevent flash-blinding.
Viewplate: Macrobinocular imaging set (100-250/500/1,000 meter range) with sensor relay.
Sensor Pack: Enables user to make passive sensor scans (no bonus); in forward focus the scanner patches into the rider's viewplate to provide navigation aid (+2D to *repulsorlift* operation)
Utility Belt: High-tension wire, grappling hooks, spare blaster power packs, ion flares, concentrated rations,



spare comlink, water packs, 2 medpacs, camo-tent, water purifier.
Source: Rules of Engagement – The Rebel SpecForce Handbook (pages 100-101), Galaxy Guide 5: Return of the Jedi (page 65), Imperial Sourcebook (page 48)

Snowtrooper Armor

Model: Standard Cold Assault Trooper Armor
Type: Cold-terrain military armor
Scale: Character
Cost: Not available for sale
Availability: 3, X
Game Notes:
Armor Protection: +1D physical and energy, -1D *Dexterity* and related skills.
Comlink: Tongue-activated helmet comlink.
Sealed Body Glove: Climate controlled body glove and breath mask allows operation in extremely cold climates and toxic-air environments.
MFTAS: Multi-Frequency Targeting Acquisition System; adds +2D to *Perception* checks in low-visibility situations, +2D to ranged weapon skill uses against targets moving more than 10 meters per round; polarized lenses prevent flash-blinding.
Utility Belt: High-tension wire, grappling hooks, spare blaster power packs, ion flares, concentrated rations, spare comlink, water packs, 2 medpacs, plus a thermal tent and attachment points for snowboot slippers.
Source: Rules of Engagement – The Rebel SpecForce Handbook (page 99), Galaxy Guide 3: The Empire Strikes Back (pages 35-37), Imperial Sourcebook (pages 46-47)



Swamp Trooper Armor

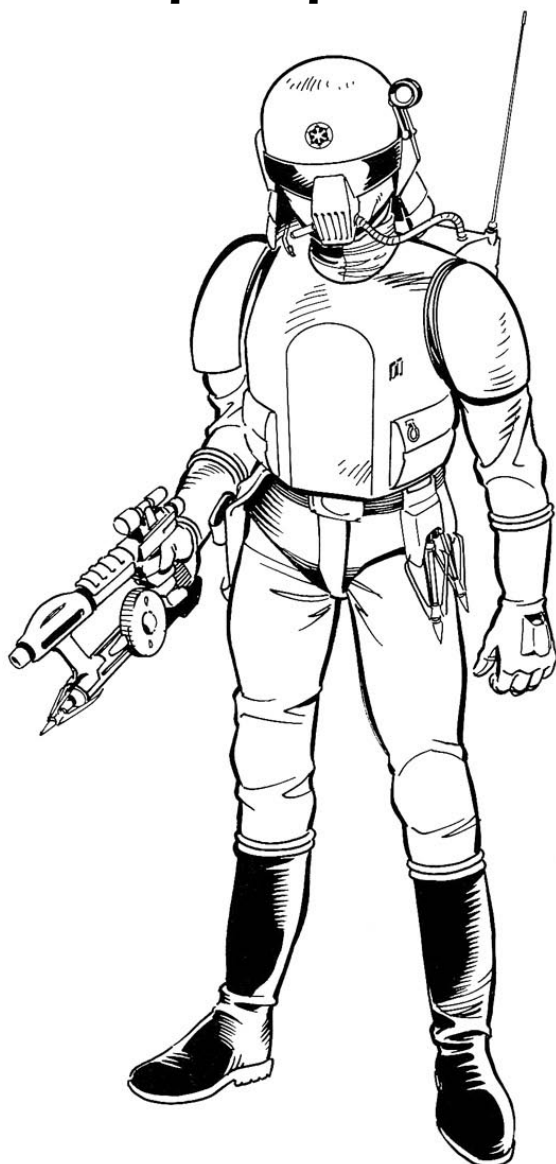

Model: Imperial Swamp Trooper Armor

Type: Military scout armor

Scale: Character

Cost: Not available for sale

Availability: 3, X

Game Notes:

Armor Protection: +1D physical and energy, -1D *Dexterity* and related skills.

Comlink: Tongue-activated helmet comlink.

Sealed Body Glove: Climate controlled body glove and breath mask allows operation in uncomfortably cold or warm climates and toxic-air environments.

Viewplate: Telescopic sight (moves target up one range level or gives +1D to *Perception*-based skills) with infrared vision, allowing full vision up to 100 meters regardless of light.

Utility Belt: High-tension wire, spare blaster power packs, ion flares, concentrated rations, spare comlink, water packs, 2 medpacs, two spare grappling hook/cords.

Source: Planet of the Mists (pages 18-20)

Raptor Commando Armor

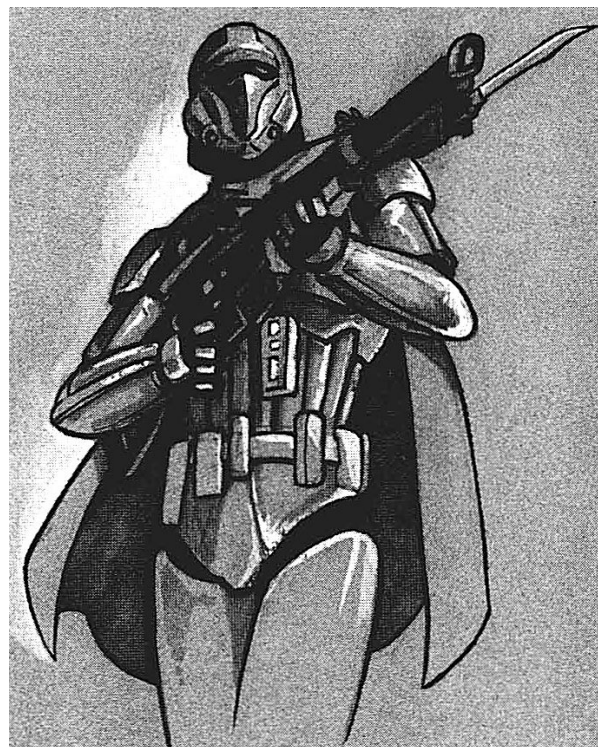

Model: Raptor Commando Armor

Type: Combat armor

Cost: Not available for sale

Availability: X

Game Notes: +1D to *Strength* to resist physical and energy damage, all locations, no *Dexterity* penalty.

Source: Cracken's Threat Dossier (page 37)

Storm Commando Armor

Model: Imperial Munitions Storm Commando Armor

Type: Lightweight personal battle armor

Cost: Not for sale*

Availability: 3, X

Armor Protection: +1D physical and energy.

Comlink: Tongue-activated helmet comlink.

Sealed Body Glove: Climate controlled body glove and breath mask allows operation in uncomfortably cold or warm climates and toxic-air environments.

MFTAS: Multi-Frequency Targeting Acquisition System; adds +3D to *Perception* and *search* checks in low-visibility situations, +2D to ranged weapon skill uses against targets moving more than 10 meters per round; polarized lenses prevent flash-blinding.

Viewplate: Macrobinoocular imaging set (100-250/500/1,000 meters range) with UV nightvision (See MFTAS, above)

Utility Belt: High-tension wire, grappling hooks, spare blaster power packs, ion flares, concentrated rations, spare comlink, water packs, 2 medpacs, additional supplies pouches.

Stealth Coating: Special black *reflec* polymer coating hides wearer from sensor scans; +1D to *hide* and *sneak*.

*Storm Commando armor is classified as a military secret and carries the same penalty as possession of rastrooper armor. On the black market, Storm Commando armor is believed to cost upwards of 10,000 credits.

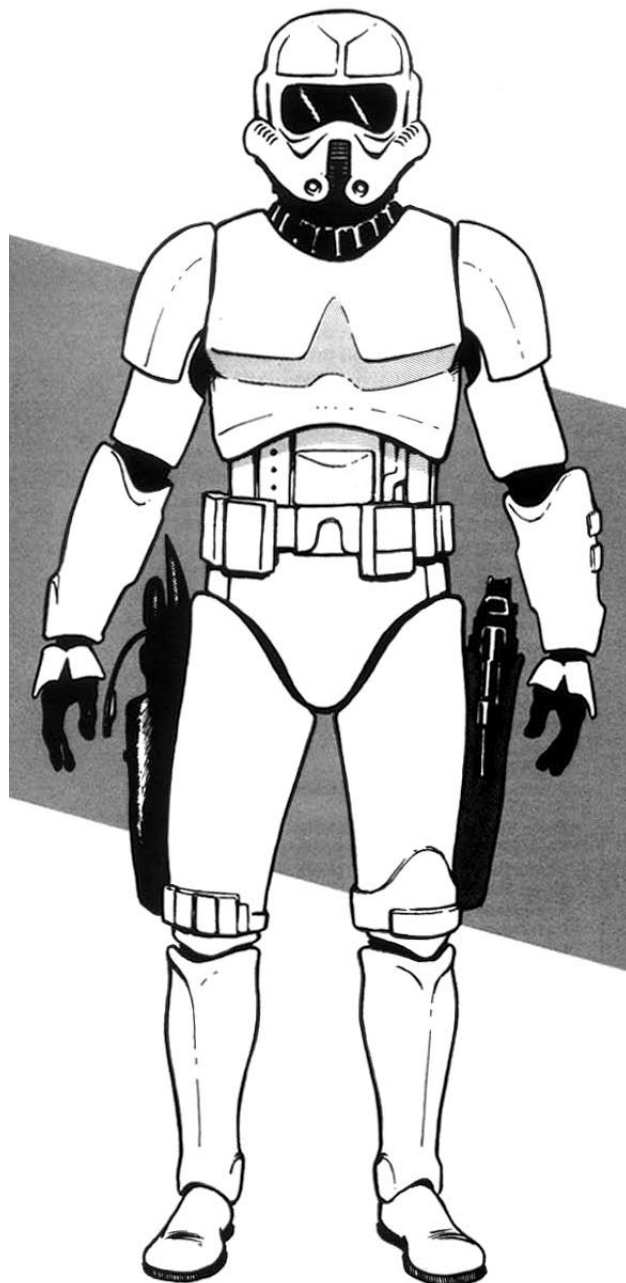
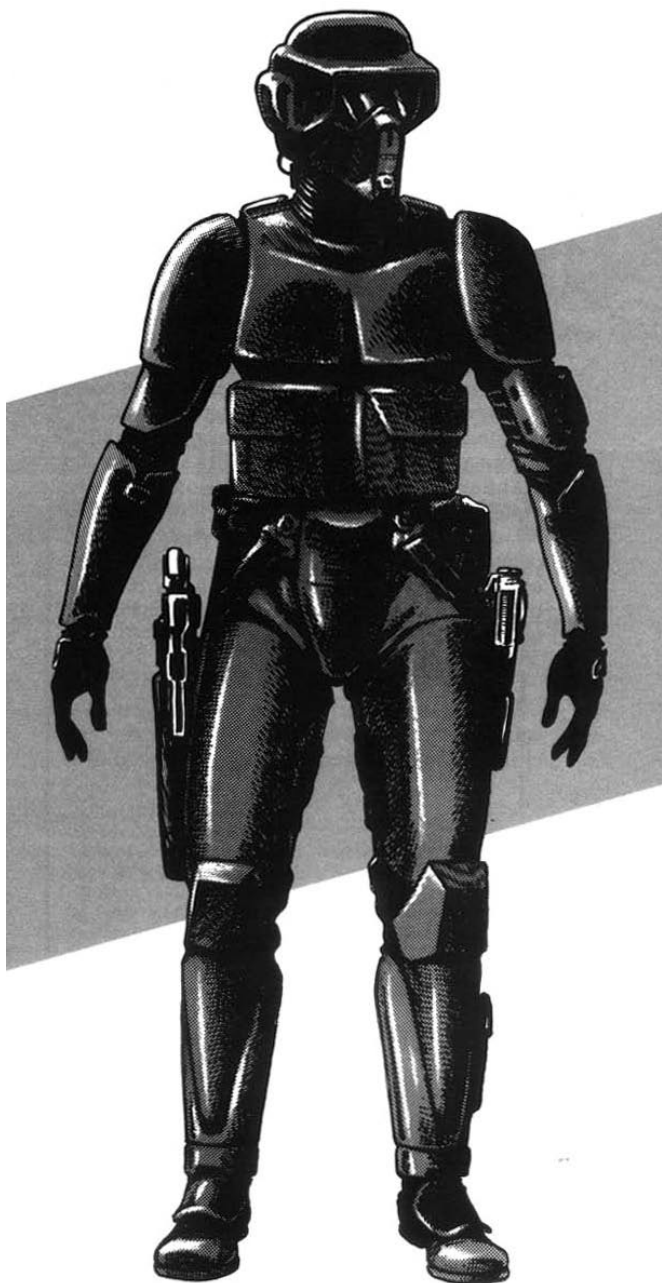

Source: Galaxy Guide 9: Fragments from the Rim (page 29), Rules of Engagement – The Rebel SpecForce Handbook (page 102), The Far Orbit Project (page 144)

Raddtrooper Armor

Model: Imperial Munitions Radiation Zone Trooper Armor

Type: Radiation-zone personal battle armor

Cost: Not for sale*

Availability: X

Armor Protection: +3D physical, +1D energy, -1D *Dexterity* and related skills.

Comlink: Tongue-activated helmet comlink.

Sealed Body Glove: Climate controlled anti-radiation body glove and breath mask allows operation in uncomfortably cold or warm climates, toxic-air environments, and light radiation zones.

MFTAS: Multi-Frequency Targeting Acquisition System; adds +2D to *Perception* checks in low-visibility situations, +2D to ranged weapon skill uses against targets moving

more than 10 meters per round; polarized lenses prevent flash-blinding.

Utility Belt: High-tension wire, grappling hooks, spare blaster power packs, ion flares, concentrated rations, spare comlink, water packs, 2 medpacs, plus anti-radiation pills, two additional detox hypos, radiation tent, water purifier, extra breathing filters, and radiation meter.

Anti-Radiation: The armor is treated with a radiation reflective coating, which insulates the wearer against heavy radiation zones. A heat and radiation backpack colling unit supplements the body glove in heavy radiation.

*Raddtrooper armor is classified as a military secret, so possession of such armor is punishable by life imprisonment or execution. Those few sets of armor that have reached the black market are believed to have sold for over 50,000 credits. It is believed that this highly specialized armor costs the Empire over 25,000 credits per suit.

Source: Galaxy Guide 9: Fragments from the Rim (page 28), Rules of Engagement – The Rebel SpecForce Handbook (page 101)

Seatrooper Armor

Model: Standard Aquatic Assault Trooper Armor

Type: Underwater military armor

Scale: Character

Cost: Not available for sale

Availability: 3, X

Game Notes:

Armor Protection: +1D physical and energy, +2D swimming skill.

Comlink: Tongue-activated helmet comlink.

Sealed Body Glove: Climate controlled body glove and breath mask allows operation in uncomfortably cold or warm climates and toxic-air environments. Helmet draws air from tank, and has a one-hour emergency r e b r e a t h e r attachment.

MFTAS: Multi-Frequency Targeting Acquisition System; adds +2D to *Perception* checks in low-visibility situations, +2D to ranged weapon skill uses against targets moving more than 10 meters per round; polarized lenses prevent flash-blinding.

Utility Belt: High-tension wire, grappling hooks, spare blaster power packs, ion flares, concentrated rations, spare comlink, water packs, 2 medpacs, spare breather, and compressed-air inflated bubble tent.

Source: Rules of Engagement – The Rebel SpecForce Handbook (page 99), Imperial Sourcebook (page 47)

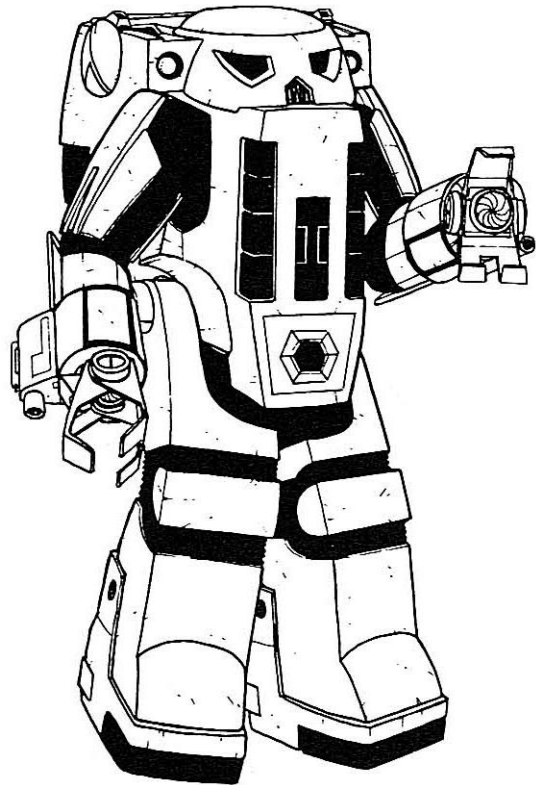

Ammo: 30

Blast Radius: 0-2/4/6/8

Damage: 5D/4D/3D/2D (stun),

Mini-Proton Torpedo Launcher

Scale: Character

Skill: Starship gunnery

Range: 25-100/300/700 (space: 1/3/7)

Ammo: 6

Damage: 6D

Blaster Cannon

Scale: Character

Skill: Blaster

Range: 10-50/100/150

Damage: 6D

Laser Cutters

Scale: Starfighter

Skill: Blaster

Range: 0.3 meters

Damage: 3D

Game Notes:

Basic Suit: Four hours of power and 10 hours of oxygen. Has a Space Move of 1; in normal gravity, Move is only 8.

Armor Protection: +4D physical, +3D energy to resist damage, reduces *Dexterity* and related skills by -1D.

Magnetic couplers: Allow adherence to any metal surface.

Internal Environment: Climate-controlled powersuit allows operation in uncomfortably cold or warm climates.

MFTAS: Multi-Frequency Targeting Acquisition System; adds +2D to *Perception* checks in low-visibility situations, +2D to ranged weapon skill uses against targets moving more than 10 meters per round; polarized lenses prevent flash-blinding.

Source: Rules of Engagement – The Rebel SpecForce Handbook (page 100), Imperial Sourcebook (pages 47-48), Heir to the Empire Sourcebook (page 55), The DarkStryder Campaign – The Kathol Rift (page 69), The Star Wars Sourcebook (page 107)

Spacetrooper Armor

Model: Standard Zergo-G Assault Stormtrooper Armor Mark I

Type: Zero-g military power armor

Scale: Character

Skill: Powersuit operation: spacetrooper armor

Cost: Not available for sale

Availability: 3, X

Weapons:

Grenade Launcher

Scale: Character

Skill: missile weapons

Range: 5-50/100/200 (space: 0/1/2)

Game Notes: Fires concussion grenades and gas/stun grenades.

Concussion Grenades

Ammo: 30

Blast Radius: 0-2/4/6/10

Damage: 5D/4D/3D/2D

Gas/Stun Grenades

Individual Armor

Beylyssa's Armor

Model: Modified Arelik Armor
Type: Modified personal battle armor

Cost: Not for sale
Availability: Unique

Game Notes:

Basic suit: +2D to Strength for physical attacks, +1D for energy attacks. Covers head, torso and arms. *Dexterity* and related skills are -1D.

Sensor pod: +1D to search.

Infrared Sensor: Adds +1D to Perception in darkness

Turbo Projected Grappling Hook: 20 meter lanyard, uses *missile weapon* skill (ranges 0-3/10/20), spring-barbed hook (3D+2 damage if used on a live target).

Winch: capable of lifting 100 kilograms.

Environment filter: Helmet filter system can prevent harmful molecules from entering the lungs.

Source: Adventure Journal 3 (page 286)



Model: Modified Mandalorian battle armor

Type: Modified personal battle armor

Cost: Not for sale

Availability: Unique

Game Effect:

Basic Suit: Provides +4D to Strength for physical attacks, +3D for energy attacks. Covers head, torso and arms. No *Dexterity* penalties.

Wrist Lasers: 5D damage, uses *armor weapons* skill, ranges: 3-5/25/50.

Rocket Dart launcher: 6D damage, uses *missile weapons* skill, ranges: 3-5/25/50, poison tipped (causes 5D damage for five rounds). Can use alternative poisons and stun serums.

Turbo Projected Grappling Hook: 20 meter lanyard. Uses *missile weapons* skill (ranges (1-3/10/20), magnetic grappling "hook."

Flame Projector: 5D damage, uses *armor weapons* skill, creates cone 1 meter wide, variable one to five meters long.

Concussion Grenade Launcher: Grenades cause 6D damage over a five meter blast radius. Uses *missile weapons* skill, ranges are 1-250/350/500, magazine carries 20 grenades.

Jet Pack: Has a Move of 100 meters horizontally. 70 meters vertically. Uses *jet pack operation* skill, base difficulty is Easy, modified by obstacles. Has 20 charges, can expend up to two per round.

Sensor Pod: +2D to search.

Infrared/Motion Sensor: Integrated infrared and motion sensor that adds +1D to Perception in darkness or with moving objects ahead and to both sides.

Macrobinooculars: Add +3D to Perception or search for objects 100-500 meters away. Scomp-linked into blaster rifle: reduces range two levels (for example, long range becomes short range).

Sound Sensor: Adds +1D to Perception or search. This bonus only applies in quiet situations.

Internal Comlink: Can be linked into *Slave II's* control system (with beckon call), adjusted to other standard frequencies. Also has external speaker.

Broad-band Antenna: Can intercept and decode most communications made on standard frequencies. As a result, Boba Fett can patch into shipboard communications.

Winch: Capable of lifting 100 kilograms (Fett and his equipment only).

Sealed Enviro Filter: Filter system can block out harmful molecules, or in case of insufficient or deadly atmosphere, the suit can completely seal, drawing upon a two hour internal supply of oxygen.

Source: Dark Empire Sourcebook (page 32), Galaxy Guide 3: The Empire Strikes Back (pages 52-53), Galaxy Guide 5: Return of the Jedi (page 28), Star Wars Trilogy Sourcebook SE (pages 65-66), The Movie Trilogy Sourcebook (page 90), The Star Wars Sourcebook (page 141)

Boba Fett's Battle Armor



Boushh's Armor

Model: Modified Ubese Raider Armor

Type: Modified battle armor

Cost: Not for sale

Availability: Unique

Game Notes:

Basic Suit: +2D to Strength for physical attacks, +1D for energy attacks. Covers torso and head only. No *Dexterity* penalties.

Sealed Enviro-Filter: Filter system maintains Type II atmospheres within helmet, and filters out harmful molecules and odors.

Flash Guard Visor: Nullifies all stun damage from visual sources (for instance, flash canisters or grenades).

Infrared Sensors: Adds +1D to *Perception* in darkness.

Macrobinooculars: Add +3D to *Perception* or *search* for objects 100-500 meters away.

Sound Sensors: Adds +1D to *Perception* or *search* in quiet situations only.

Spiked Knuckle Guards: STR+1 damage when brawling.

Source: Shadows of the Empire Sourcebook (page 65), No Disintegrations (page 80)



Darth Vader's Armor



Type: Unique dark armor

Scale: Character

Cost: Not for sale

Availability: Unique

Game Notes: +1D to *Strength* to resist physical and energy damage. Respiratory life-support system is necessary to keep Vader alive.

Source: The Star Wars Trilogy Sourcebook SE (page 49), The Dark Side Sourcebook (page 93), Rebellion Era Sourcebook (page 34)

Dej Vennor's Armor

Model: Modified Imperial Scout Armor

Type: Bounty hunter armor

Scale: Character

Skill: Powersuit operation

Cost: Not available for sale

Availability: Unique

Game Notes:

Basic Suit: Vennor's armor provides +1D protection versus physical and energy attacks, with no *Dexterity* penalty. Suit has a move of 20 (rolled on *powersuit operation*).

Power Suit: +1D to *climbing/jumping* and *lifting*.

Sensor Pod: +1D to *search*.

Internal Line Slinger: 20-meter range. Standard line is tipped with a magnetic or claw grappler. Roll *missile weapons* to fire.

Jet Pack: Can move 100 meters horizontally or 30 meters vertically in a single round. Has 20 charges and can expend 2 per round until exhausted.

Sealed Enviro Filter: Filter system can block out harmful gasses or toxins for up to two hours. Provides protection in vacuum.

Motion Sensor: Neuro-Saav MacroMotionMonitor. Adds +1D to *search* rolls involving motion up to 50 meters away.

Reflec Coating: Vennor's armor has been coated with the sensor absorbing compound, *reflec*. If he is not being actively scanned for, he adds +1D to his *hide* and *sneak* rolls.

Wrist Lasers: Hold 15 shots per unit, and inflict 4D damage to targets within 3 meters.

Source: The Far Orbit Project (page 97)

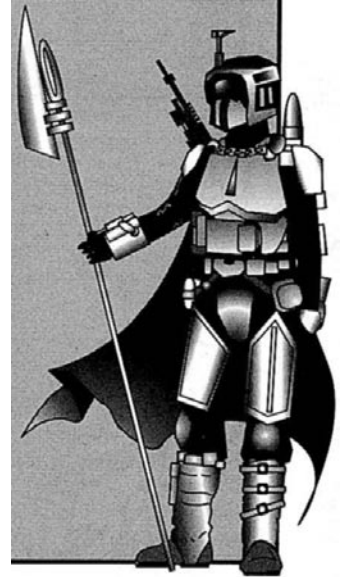

Dengar's Blast Armor



Type: Modified blast armor

Cost: Not for sale

Availability: Unique

Game Notes: +2D+2 physical, +1D+2 energy to torso, arms and legs, chest-mounted comlink.

Source: Galaxy Guide 3: The Empire Strikes Back (page 55), Galaxy Guide 10: Bounty Hunters (page 68), Star Wars Trilogy Sourcebook SE (page 63)

Jango Fett's Battle Armor



Model: Modified Mandalorian battle armor

Type: Modified personal battle armor

Cost: Not for sale

Availability: Unique

Game Effect:

Basic Suit: Provides +4D to *Strength* for physical attacks, +3D+1 for energy attacks. Covers head, torso and arms. -1 penalty to *Dexterity* and related skills.

Saberdart Launcher: Uses Kamino Saberdart with Kouhun venom: Victim must make a Moderate *stamina* roll or die. Succeeding the roll mean victim only suffers a -2D *Strength* penalty. Uses *missile weapons* skill, ranges are 3-10/30/120. Carries 4 darts.

Wrist Rocket Launcher: 3D damage over a 2 meters blast radius. Uses *missile weapons* skill, ranges are 1-3-10/30/120.

Missile Launcher: 6D damage over a five meter blast radius. Uses *missile weapons* skill, ranges are 1-250/350/500.

Rocket Dart launcher: 6D damage, uses *missile weapons* skill, ranges: 3-5/25/50, poison tipped (causes 5D damage for five rounds). Can use alternative poisons and stun serums.

Turbo Projected Grappling Hook: 20 meter lanyard. Uses *missile weapons* skill (ranges (1-3/10/20), magnetic grappling "hook."

Flame Projector: 5D damage, uses *armor weapons* skill, creates cone 1 meter wide, variable one to five meters long.

Wrist Blades: retractable blades do STR+1D damage, uses *melee combat* skill.

Jet Pack: Has a Move of 100 meters horizontally. 70 meters vertically. Uses *jet pack operation* skill, base difficulty is Easy, modified by obstacles. Has 20 charges, can expend up to two per round.

Sensor Pod: +2D to *search*.

Infrared/Motion Sensor: Integrated infrared and motion

sensor that adds +1D to *Perception* in darkness or with moving objects ahead and to both sides.

Macrobinoculars: Add +3D to *Perception* or *search* for objects 100-500 meters away. Scomp-linked into blaster rifle: reduces range two levels (for example, long range becomes short range).

Sound Sensor: Adds +1D to *Perception* or *search*. This bonus only applies in quiet situations.

Internal Comlink: Can be linked into *Slave 1's* control system (with beckon call), adjusted to other standard frequencies. Also has external speaker.

Broad-band Antenna: Can intercept and decode most communications made on standard frequencies. As a result, Boba Fett can patch into shipboard communications.

Sealed Enviro Filter: Filter system can block out harmful molecules, or in case of insufficient or deadly atmosphere, the suit can completely seal, drawing upon a two hour internal supply of oxygen.

Source: d20 Core Rulebook (page 316)

Jodo Kast's Battle Armor



Model: Modified Mandalorian battle armor

Type: Modified personal battle armor

Cost: Not for sale

Availability: Unique

Game Effect:

Basic Suit: Provides +2D to *Strength* for physical attacks, +1D for energy attacks. Covers head, torso and arms. No *Dexterity* penalties.

Wrist Lasers: 5D damage, uses *armor weapons* skill, ranges: 3-5/25/35.

Flame Projector: 5D damage, uses *armor weapons* skill, creates cone 1 meter wide, variable 1-5 meters long.

Sensor Pod: +2D to *search*.

Infrared/Motion Sensor: Integrated sensor adds +1D to *Perception* in darkness or with moving objects forward and to both sides.

Macrobinoculars: Add +2D to *Perception* or *search* for objects 100-300 meters away. Scomp-linked into blaster rifle, reduces range two levels (for example, long range becomes short range).

Broad-band Antenna: Can intercept and decode most communications made on standard frequencies.

Source: Galaxy Guide 10: Bounty Hunters (page 62)

Mist's Bounty Hunter Armor

Model: Modified Krail Armory Model 1010 Photo-reactive Personal Armor

Type: Modified personal battle armor

Skill: Powersuit operation: Krail 1010 armor

Cost: (with all modifications) 80,000

Availability: Basic suit is X on most planets; modified suit in unique

Game Effects:

Basic Suit: Protection +2D to *Strength* for energy attacks, +2D+1 to physical attacks; -1D to *Dexterity* and related skills. Suit has a Move of 15, with movement rolled on *powersuit operations* skill.

Power Suit: +1D to *lifting*.

Sensor Pod: +1D+1 to *search*.

Integral Flechette Launcher: 20-meter range, rolled on *blaster* skill (causes 3D stun damage).

Jet Pack: Move of 100 meters horizontally, 65 meters vertically. Uses *jet pack operation* skill, base difficulty is Easy, modified by obstacles. Has 16 charges, two of which can be expended per round.

Sealed Enviro Filter: Filter system blocks out harmful molecules, or in case of insufficient or deadly air supply, the unit can completely seal, drawing on three hour oxygen supply. In addition, the helmet's filter contains a voice disguiser, rendering attempts at voiceprint identifications futile.

Photo-reactive Coating: The armor has a coating of photosensitive microscopic crystals that reflect the ambient colors in a given area, making the armor difficult to see in virtually any situation. This adds +2D to *sneak*.

Reflec Plating: In addition to enhanced camouflage, the armor is covered in a fine mesh of *reflec*, a sensor absorbing material favored by the Imperial Storm Commandos, adding an additional +1D to *sneak*.

Source: The DarkStryder Campaign – The Kathol Outback (page 20), – The Kathol Rift (page 67), – Endgame (page 115)

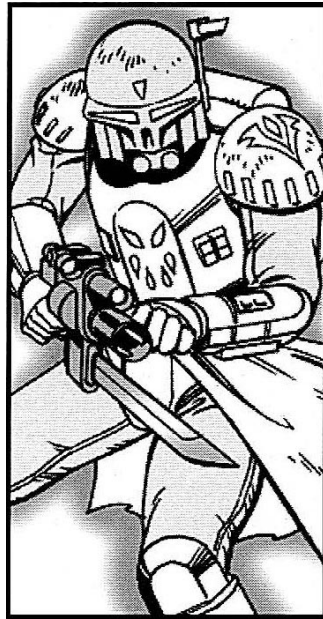

Source: Gamer Magazine

Stormtrooper X's Modified Stormtrooper Helmet

Model: Modified Stormtrooper Helmet

Type: Military Armor

Scale: Character

Cost: Not available for sale

Availability: 3, X

Game Notes: Provides +2D physical and +1D energy protection (head). This stormtrooper helmet is similar to the one described in the Rulebook, but with the following modifications: the helmet's comlink has a broadband antenna that increases its range to 400 kilometers. In addition, it is equipped with a signal interceptor that allows the wearer to eavesdrop on encrypted communications with a Very Difficult *communications* skill roll.

Shields

Dampener Aerosol

Model: Zemphyr Defenders, Incorporated Passive Defender PD-0943
Type: Blaster dispersion system
Cost: 600
Availability: 4, F or R
Game Notes: The PD Canister is a cylinder 10 centimeters long by 4 centimeters in diameter; it has three charges. Each charge produces a visible cloud that covers a one meter cubic area. Any blaster bolt entering the cloud loses -1D of damage. The cloud lasts for one minute (barring heavy winds or precipitation). Additional charges in the same area have no additional benefit.
Source: Galladinium's Fantastic Technology (page 80), Arms and Equipment Guide (page 45)

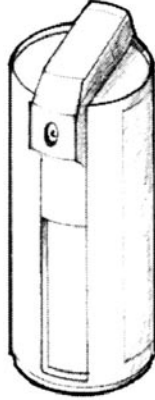

Shield Gauntlet

Model: Kilian Shield Gauntlet
Type: Energy shield
Scale: Character
Skill: Melee parry
Cost: Not available for sale
Availability: 4, X
Game Notes: An activated shield gauntlet can be used to parry incoming brawling and melee attacks. In addition, the activated gauntlet provides a +1 pip bonus to all *Strength* rolls made to resist damage.
Source: Rebellion Era Sourcebook (page 49)



Primitive Shield

Type: Wood or hide shield
Scale: Character
Skill: Melee parry: shield
Cost: 50
Availability: 2
Game Notes: Blocks brawling, melee or ranged attacks on a successful *melee parry* roll. The shield has a *Strength* of 3D.
Source: Ultimate Adversaries (page 155)

Beastwarden's Shield

Model: Geonosian Beastwarden's Shield
Type: Spike-rimmed shield
Scale: Character
Skill: Melee parry: shield/Thrown weapons
Cost: 200
Availability: 3

Range: 3-4/8/12
Damage: STR+2
Game Notes: Blocks brawling, melee or ranged attacks on a successful *melee parry* roll. The shield has a *Strength* of 4D. This bronze disc with sharp spikes along its rim can be hurled as a thrown weapon.
Source: Geonosis and the Outer Rim Worlds (page 61)

Riot Shield

Model: Drearian Defense Activv1 Riot Shield
Type: Riot shield
Scale: Character
Skill: Melee parry
Cost: 500
Availability: 2, R
Difficulty: Easy
Damage: 4D (stun)
Game Notes: If the character makes the skill roll, the user has used the shield to block incoming attacks on one facing. The shield has a *Strength* of 4D. If used as a melee weapon, it causes STR+2 damage as well as 4D stun damage. Using the firing notch adds one level to the difficulty of firing blasters, but the character is protected by the shield. The stun charge lasts for one hour of consecutive use.
Source: Gundark's Fantastic Technology (page 59), Han Solo and the Corporate Sector Sourcebook (page 116), Ultimate Adversaries (page 155)

Magnaforce Security Shield

Model: Simcronics MagnaForce Security Shield
Type: Personal defensive field generator
Skill: Melee parry
Cost: 25,000 pair, 2,500 (custom power cells)
Availability: 4, F, R or X
Game Notes: This unit is used much like starship shields, except that it is character scale. Initial activation requires an Easy *melee parry* roll, which generates a round shield 50 centimeters in diameter. A character may make a *melee parry* roll – if the roll is higher than the firer's *blaster* roll (as per normal shield rolls), the wearer has placed the force shield in the way. If the roll is lower than the attacker's *blaster* roll, the character didn't get the shield in place in time and was hit by the blast. If the defender got the shield in place, the blaster bolt must roll against the shield's defensive field of 4D to see if it penetrates the field (use the protection rules). Any further damage affects the target as indicated in the chart "Cover Modifiers". The power cell will work for two minutes before being drained.
Source: Galladinium's Fantastic Technology (page 92)

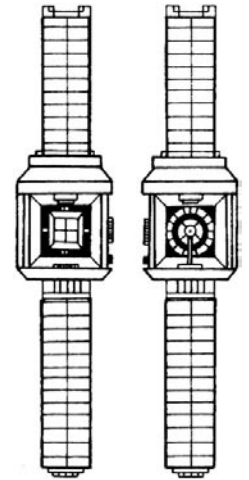

Personal Energy Shield

Model: Otoh Gunga Defense League Standard Issue Energy Shield
Type: Personal energy shield
Scale: Character
Skill: Melee parry: personal energy shield
Cost: Not available for sale



Availability: 3

Game Notes: This personal energy shield is held and wielded much like a normal shield. The user makes a *melee parry* skill roll to deflect incoming attacks, be they from melee weapons or blasters. Success indicates that the shield takes the damage. The shield has a *Strength* of 5D. If the damage roll is greater than the shield's *Strength* roll, excess damage affects the shield bearer. Every time the shield is compromised, the protection value is reduced by 1D.

Source: Secrets of Naboo (pages 49-50)

“Hardpoint” Heavy Weapons Armor

Model: Imperial Munitions “Rampart” Blast Armor

Type: Portable heavy armor

Scale: Character

Cost: 10,000

Availability: X

Game Notes: Provides +3D protection against physical attacks, +2D against energy attacks. These emplacements take 10 hours to set up and properly anchor, requiring a Moderate *Technical* roll to successfully install them. The armor has been formed to provide ample cover for an E-Web blaster, two gunners and a power generator.

Source: The DarkStryder Campaign - Endgame (page 101)

Portable Shield Generator

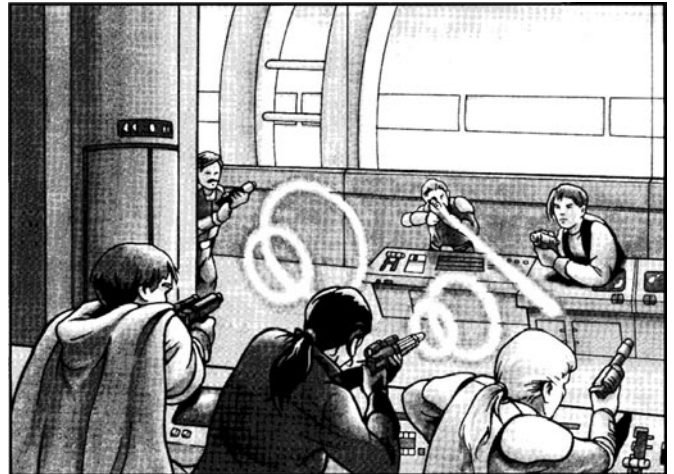

Model: Imperial Munitions Rampart II Shield Generator

Type: Portable shield generator

Scale: Character

Skill: Computer programming/repair

Crew: 1

Game Notes: Provides 6D character-scale protection to those behind the shield. These shields are currently configured to one of two settings, either closing off an entire corridor, or standing roughly 1.5 meters high, and stretching 6 meters wide, allowing ample protection while permitting return fire. When the shield is struck, roll 6D versus the damage code of the weapon fired. If this total is lower than the weapon's damage roll, the generator's protection drops -1D; when the shield reaches 0D, it is destroyed.

Source: The DarkStryder Campaign - The Kathol Rift (page 50)

Gungan Portable Shield Generator

Model: Otoh Gunga Stock Shield Generator Units

Type: Portable blast shield

Scale: Speeder

Cost: Not available for sale

Crew: 2 operators (one for the capacitor, one for the

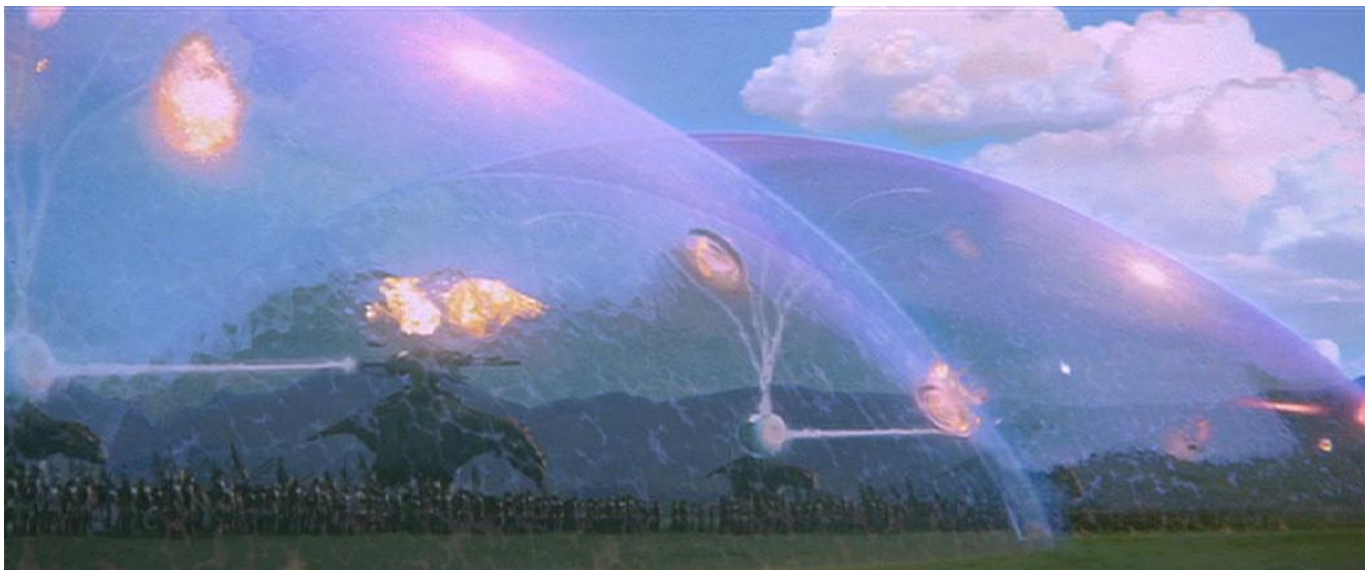



generator), 2 fambaas, plus any fambaa handlers

Availability: 3

Game Notes: This is a portable shield generator used by Gungans. It projects a circular shield canopy that provides protection for everything within a 75-meter radius of the capacitor. Multiple shields can be positioned so that their effects overlap. A shield provides 5D of protection from small, fast-moving objects that produce extreme heat (such as projectiles from weapons fire, as well as lasers and blasters), and restricts the movement of large, slow-moving objects (such as troop transports and tanks). It will not stop the passage of small, slow-moving object, such as foot soldiers, nor will it protect against small projectiles that generate no energy signatures or only miniscule amounts of heat (such as arrows). Each time damage penetrates the force field, it loses 1D from its rating.

Source: Secrets of Naboo (page 50)

Base Shield Generator

Model: Merr-Sonn Guardian-class Shield Generator

Type: Base shield generator

Scale: Capital

Skill: Shields

Crew: 2

Cost: 60,000

Availability: 3, R

Game Notes: Includes both particle and energy shields. For each unit installed, 6D of protection can be called upon for up to 4 fire arcs.

Source: Hideouts & Strongholds (page 13)



WorldArmor 4 Shield Generator

Model: WorldArmor 4 Defensive Shield

Type: Planetary defense shield

Scale: Capital

Skill: Planetary shields

Crew: 25

Cover: Full

Ammo: Power generator

Cost: 80 millions

Body: 3D

Shield: 5D

Range: 1/3/5

Difficulty: Easy (short range or half-planet), Moderate (medium range or full planet), Difficult (long range or orbital station)

Source: Hideouts & Strongholds (page 64)

DefenStar Nyalsan II Planetary Shield

Model: Nyalsan II Planetary Shield

Type: Planetary defense shield

Scale: Capital

Skill: Planetary shields

Crew: 18

Cover: Full

Ammo: Power generator or power grid

Cost: 500 million credits

Body: 3D

Shield: 10D

Range: 1/2/3

Difficulty: Easy (short range or half planet), Moderate (medium range or full planet), Difficult (long range)

Game Notes: A ship may attempt to evade the shield using its sensors to determine where the shields are and move around them. Flying through shutter shields is a Moderate to Heroic task even if no attempt is being made to block the approaching ship. If the shields are being actively used to block approaching ships the difficulty is the operator's planetary shields

skill (typically 4D-5D) against the starship dodge, including scale and other modifiers.

Source: Hideouts & Strongholds (page 14)

MerrWeapons WorldArmor 9 Planetary Shield

Model: WorldArmor 9 Planetary Shield

Type: Planetary defense shield

Scale: Death Star

Crew: 25

Cover: Full

Ammo: Power generator

Cost: 12 billions

Body: 3D (capital scale)

Shield: 3D

Range: 1/3/5

Difficulty: Easy (short range or half-planet), Moderate (medium range or full planet), Difficult (long range or orbital station)

Game Notes: Planetary shields disrupt sensors and ship's power systems. Add the generator's shield dice to all sensor difficulties when attempting to sense inside the shield (including any attempt to fire through the shield using fire control), including scale modifier. For power systems, roll the shield dice against the ship's hull as damage (ship's shields don't apply), including scale modifiers.

Source: Hideouts & Strongholds (page 14)

Planetary Shield



Model: Hibomehrt-Wyrrgex DefenStar 5000

Type: Planetary shield relay system

Scale: Death Star

Skill: Planetary shields

Crew: 150, skeleton: 50/+15

Crew Skill: Planetary shields 6D

Cost: 500,000 per shield

Availability: X

Game Notes: Each shield protects a 100 square kilometer area. The shield provides 6D Death Star scale protection. Anything that hits the shield suffers 6D damage; energy bolts hitting the shields make opposed damage rolls, if the planetary shield's roll is higher the energy bolt is snuffed. If the energy bolt's roll is higher, for every 6 points by which the bolt exceeds the shield roll, 1D of damage passes through: additionally, the shield system takes damage as per normal combat results. If the shield system is damaged, the system has 5D of backup shields that can be brought on-line with a Moderate *planetary shields* roll. The shield system has a fire control of 3D. Each shield must have its own power generator.

Source: Dark Empire Sourcebook (pages 129-130)

Conveyances

Climbing Gear

Fibra-Rope

Model: Standard fibra-rope

Cost: 10 per 25 meters

Availability: 1

Game Notes: Can resist up to 750 kilograms of force before breaking.

Source: Gundark's Fantastic Technology (page 76), Tales of the Jedi Companion (page 122)

Kashyy Vine

Type: Organic rope

Cost: Not available for sale

Availability: 2

Game Notes: These vines are used as ropes and cables. They are generally 1 to 4 centimeters thick, and take damage like any living thing (in other words, they have wound levels like characters do). A Kashyy vine has a *Strength* dice rating equal to its thickness in centimeters plus one (for example, a vine three centimeters thick has a *Strength* rating of 4D). This rating is used to resist damage that is applied to the vine. If left attached to a tree, or if soaked in the proper nutrients for at least 8 hours a day, the vines will heal one wound level a day. If a cut vine is not soaked for longer than a week, its *Strength* dice drop by half and it will no longer be capable of healing naturally.

Syntherope

Model: SureGrip Climbing Syntherope

Type: Synthetic fiber line

Cost: 5

Availability: 2

Game Notes: 20 meters. Can support 500 kilograms. Using rope adds +1D to *climbing* (+2D to *climbing* if treated with FrictionGrip).

Source: Rules of Engagement – The Rebel SpecForce Handbook (page 36), Arms and Equipment Guide (page 96)

Syntherope Dispensor

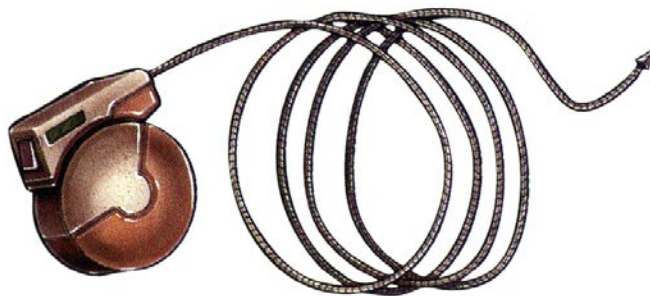

Type: Standard syntherope dispensor

Cost: 2

Availability: 1

Game Notes: Supports up to 500 kilograms of weight.

Source: Rulebook (page 228)

Gyro-Grapppler

Type: Standard gyro-grapppler

Cost: 15

Availability: 1

Game Notes: The gyro-grapppler has built-in microthrusters that activate upon throwing, propelling the device forward in the intended direction. All *climbing* skill rolls have a bonus of +1D for characters employing a gyro-grapppler in their ascent.

Source: Gundark's Fantastic Technology (page 81), Tales of the Jedi Companion (page 122)

Line Master TLG

Model: Line Master Tube-Launched Grapple (TLG)

Type: Grappling device

Scale: Character

Skill: Missile weapons

Cost: 800

Availability: 2, R

Game Notes: An easy *missile weapons* roll is required to fire the grapple on target. When the handgrip is used to freeslide down the line, the motorized winch can pull a full load up the line with a move of 2.

Source: Gundark's Fantastic Technology (page 81), Operation: Elrood (pages 85-86)

Verti-Go Line Thrower



Model: Susuax Verti-Go Climbing System

Type: Line thrower and climber

Scale: Character

Skill: Missile weapons

Ammo: 1 projectile rod, addorted grappler heads, 150-meters length of line

Cost: 400

Availability: 2

Range: 10-150 meters

Damage: 4D+2

Game Notes: The normal rate of ascent for the climbing motor is six meters per second for a normal human with gear. The secondary switch climbs at 12 meters per second but is three times as noisy (reduce *Perception* difficulty to spot climber by two levels).

Source: Gundark's Fantastic Technology (page 83)

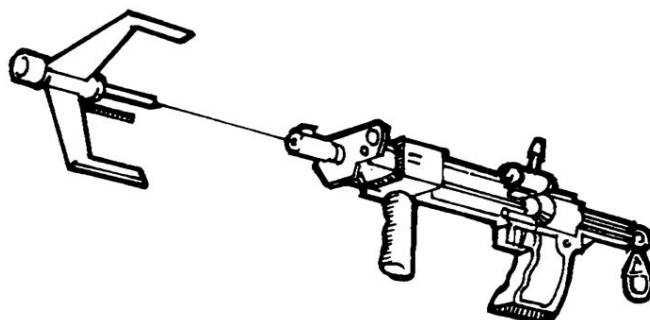

Availability: 2

Game Notes: Can be operated as a normal grappling gun, or operator can fire the gun normally, and then control the rate of ascent and direction of the repulsor-grappling hook via a thumb-operated joystick built into the gun. Hook's charge will only last 30 seconds. Gun version makes 10 launchings on a standard blaster power pack, and stores 200 meters of molecularly reinforced line. Automatic winch pulls the owner at 20 meters per second and supports 200 kilograms. Wrist version makes 5 launchings on a hold-out blaster power pack, and stores 100 meters of line. Ascends at 10 meters per second and supports 150 kilograms.

Source: Galladinium's Fantastic Technology (page 55)

Climbing Boots and Gloves



Model: SureGrip Climbing Boot and Glove Set

Type: Friction coated hand and footwear

Cost: 80

Availability: 2

Game Notes: Use of boots and gloves together enhances *climbing* by +1D. If used separately, they enhance *climbing* by +1.

Source: Rules of Engagement - The Rebel SpecForce Handbook (page 35)

Grappling Gun

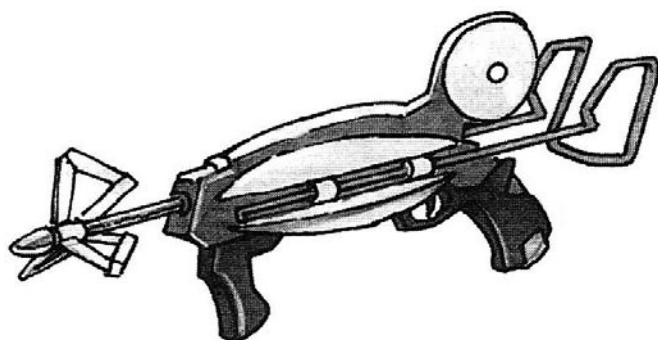

Model: Zone Control Grappling Gun

Type: Grappling gun

Scale: Character

Skill: Firearms

Cost: 1,000

Availability: 2

Range: 3-25/50/200

Damage: 3D+1

Game Notes: Moderate *firearms* difficulty to grapple a suitable support, Difficult to grapple a specific support. Winch can reel the user up at a rate of 20 meters per round.

Source: Rules of Engagement - The Rebel SpecForce Handbook (page 36)

Repulsorlift Grappling Gun

Model: Zone Control Repulsor Grappling Gun

Type: Repulsor grappling gun

Scale: Character

Skill: Firearms

Cost: 1,200 (gun), 1,000 (wrist)

Tree-Claw

Model: Nosaurian Tree-Claw

Type: Climbing claw

Scale: Character

Skill: Climbing

Cost: 100 (pair)

Availability: 2

Game Notes: A pair of tree-claws grant their wearer a +1D bonus to *climbing* rolls.

Source: Coruscant and the Core Worlds (pages 115-116)

Power Pitons

Model: MTS 56T

Type: Climbing aid

Skill: Dexterity

Cost: 300

Availability: 2

Game Notes: Using a set of power pitons (all four) adds a +2D bonus to *climbing* rolls with an Easy *Dexterity* roll. If only two pitons are used (just foot or hand pitons), the bonus is reduced to +1D.

Source: Lord of the Expanse – Sector Guide (pages 47-48)

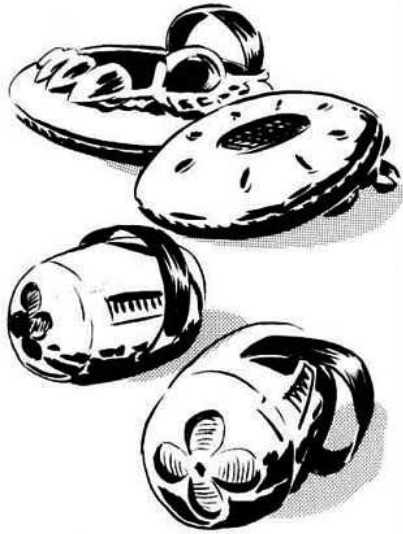

Adhesion Disc



Model: Alliance Adhesion Disc

Type: Climbing discs

Cost: Not for sale

Availability: 3

Game Notes: Enhances *climbing* by +2D.

Source: Rules of Engagement – The Rebel SpecForce Handbook (page 36)

Climbsuit

Model: Ayellixe/Krongbing Textiles Climbsuit

Type: Climbing suit

Cost: 350

Availability: 2

Game Notes: Adds +2D to *climbing*.

Source: Rules of Engagement – The Rebel SpecForce Handbook (page 35), Arms and Equipment Guide (page 40)



Repulsors

Iyra Gravity Belt

Model: Iyranis Gravitics Limited Gravity Belt

Type: Gravity belt
Skill: Repulsorlift operation

Cost: 500

Availability: 3

Game Notes: Slows free-fall velocity to a gentle landing.

Source: Galladinium's Fantastic Technology (page 44)

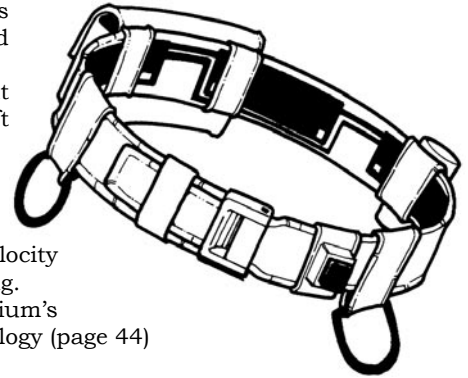

Cloud Jumper

Type: Repulsorlift personal jump pack

Scale: Character

Skill: Repulsorlift operation

Cost: Not available for sale

Availability: 3, R

Game Notes: The pack is not a true rocket pack in the sense that the wearer can "fly". Instead, the pack allows the wearer to make incredible leaps, over 200 meters at a time, from point to point. The pack can also be used to slow the descent of a person who is free-falling, allowing a soft landing in most cases.

Source: The DarkStryder Campaign – The Kathol Outback (page 77)

Grav Boots

Model: Corgorlath Leisure Articles Master-Grav 1000

Type: Grav boots

Skill: Powersuit operation

Cost: 550 (pair)

Availability: 2

Game Notes: Move is up to 20 meters per round and maximum altitude is 150 meters. The unit is relatively quiet. Various difficulty maneuvers may be attempted, using the *powersuit operation* skill.

Source: Galladinium's Fantastic Technology (pages 50-51)



Aratech R82 Jump Boots

Model: Aratech R82 Jump Boots

Type: Repulsor boots

Skill: Repulsorlift operation (repulsor engine), rocket pack operation (rockets)

Cost: 150, 25 (fuel)

Availability: 2

Game Notes:

Repulsorlift Engine: Can operate up to one hour before power packs must be replaced. Has a flight ceiling of 35 meters and a Move of 18.

Rocket Jets: Holds enough fuel for five blasts, which can move the wearer up to 25 meters vertically or 50 meters horizontally.

Source: Galladinium's Fantastic Technology (pages 62-63), Rules of Engagement – The Rebel SpecForce Handbook (page 51)

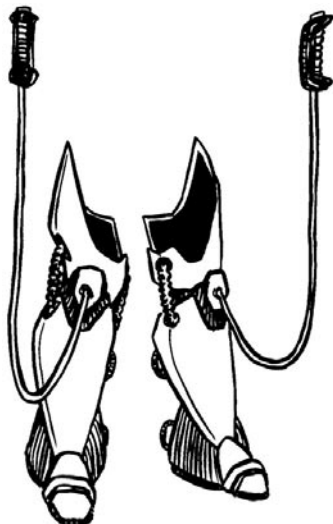

Repulsorlift Cart

Model: Ubrikkian Model 8 Cargo Platform

Type: Repulsor cart

Cost: 100

Availability: 2

Game Notes: Cart is 2 meters long and 1.5 meters wide. Raised railings at each end have clips for straps and nets to restrain cargo. Cart has fixed altitude of 0.35 meters.

Source: Platt's Smugglers Guide (pages 49-50)

Repulsorlift Baggage Cart

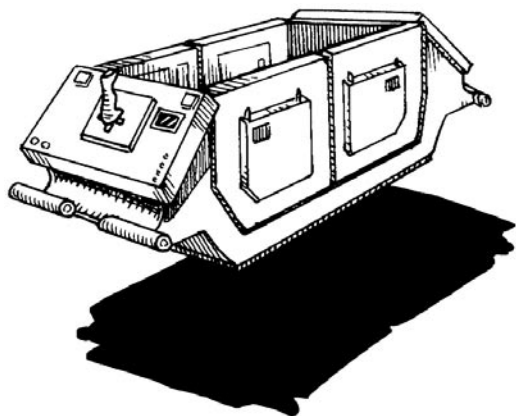

Model: Falkenharn Repulsors Mark V14 Baggage Handler

Type: Personal repulsor conveyor

Cost: 250, 50 (infrared guide stick)

Availability: 2

Game Notes: When fully extended and locked into place, the carrier is 1.75 meters long, 80 centimeters wide and 65 centimeters tall. Left and right sections are hinged and can be folded back for storage. Manual steering handle (removable) and lift control studs are located at each end. Three miniaturized repulsor inducers and inertia dampeners are located along bottom surface layers and covered by a protective grill. When fully charged, this carrier provides continuous lift for 100 standard hours. Flotation height distance is adjustable to 1.8 meters. An optional infrared guide stick allows for hands-off control of the carrier within an effective range of 10 meters.

Source: Galladinium's Fantastic Technology (page 64)

Flotation Lifter

Model: Haileycraft MaxMode Lifter

Type: Underwater flotation lifter

Skill: Repulsorlift operation

Cost: 1,000

Availability: 3 in coastal areas, 4 elsewhere

Game Notes: The lifter is an underwater mechanical device used by divers to lift light loads to the surface. It is not an industrial lifter and cannot lift extremely heavy loads. It can handle supply crates and three divers hanging on to straps on the sides, in addition to the "driver".

Source: Adventure Journal 1 (page 70)

Jet Packs

Leaper Jet Pack

Model: Merr-Sonn Leaper Jet Pack

Type: Personal jet pack

Scale: Character

Skill: Jet pack operation

Cost: 300

Availability: 3, F

Weight: 25 kilograms

Game Notes: Carries single passenger plus 25 kilograms of cargo, 100 meters horizontally or 30 meters vertically. Fuel capacity for 10 bursts.

Source: Galladinium's Fantastic Technology (page 13)

Jumper Jet Pack

Model: Aratech Jumper Jet Pack

Type: Personal jet pack

Scale: Character

Skill: Jet pack operation

Cost: 200

Availability: 2, R

Weight: 40 kilograms

Game Notes: Fuel capacity for 8 bursts. Carries single passenger 100 meters horizontally or 65 meters vertically. May carry up to 100 kilograms total.

Source: Galladinium's Fantastic Technology (page 13)

NJP-433 Jet Pack

Model: Nanogar NJP-433 Jet Pack

Type: Personal jet pack

Skill: Jet pack operation

Cost: 400

Availability: 2, R

Weight: 20 kilograms

Game Notes: Capable of lifting up to 250 kilograms (total). It moves vertically 50 meters per charge, horizontally up to 150 meters per charge. A fully charged unit has 5 charges.

Source: Galladinium's Fantastic Technology (page 13)

Screamer Jumper Jet Pack



Model: Aratech Screamer Jumper Jet Pack

Type: Personal jet pack

Scale: Character

Skill: Jet pack operation

Cost: 250 (fuel 50)

Availability: 1

Weight: 45 kilograms

Game Notes: Fuel capacity for 10 bursts. Carries single passenger 100 meters horizontally or 70 meters vertically. Can slow descent to prevent injury from falling, requiring one burst per 200 meters fallen. After each burst the engines must be allowed to cool for one round. Requires *Easy jet pack operation* to use. May carry up to 75 kilograms of cargo, or another passenger, but distance traveled is halved.

Source: Cracken's Rebel Field Guide (page 43)

Swiftsure Jet Pack

Model: Moreldahl Swiftsure Jet Pack

Type: Personal jet pack

Skill: Jet pack operation

Cost: 300

Availability: 2, R

Weight: 40 kilograms

Game Notes: Capable of lifting up to 90 kilograms (total). It moves vertically 70 meters per charge, horizontally up to 100 meters per charge. A fully charged unit has 20 charges.

Source: Galladinium's Fantastic Technology (page 13)

Whisper Jet Pack

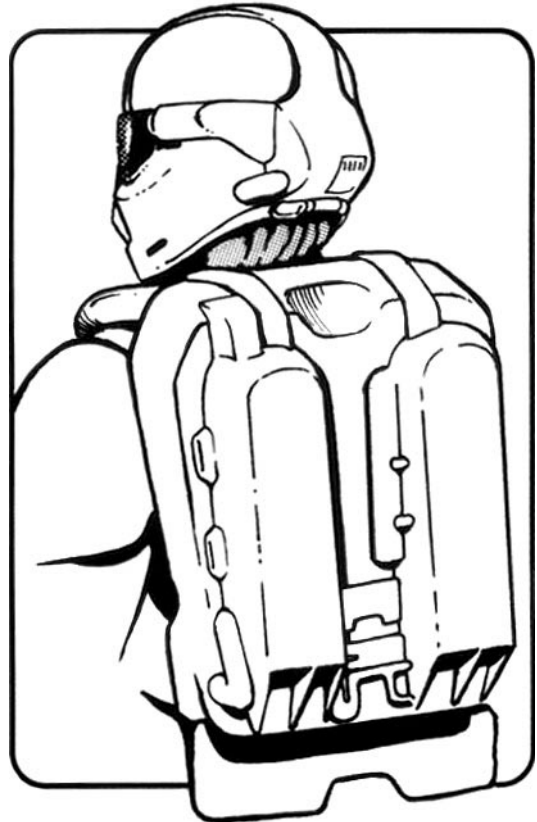

Model: Arakyd Aerodynes Inc. Whisper

Type: Personal jet pack

Skill: Jet pack operation

Cost: 400

Availability: 3, F

Weight: 30 kilograms

Body Strength: 2D

Game Notes: The Arakyd Whisper is capable of lifting up to 150 kilograms (total). It moves vertically 70 meters per charge, horizontally up to 100 meters per charge. A fully charged unit has 20 charges.

Source: Galaxy Guide 9: Fragments from the Rim (pages 31-32), Galladinium's Fantastic Technology (pages 11-12), Rules of Engagement – The Rebel SpecForce Handbook (page 51)

Z-6 Jet Pack



Model: Mitrinomom Z-6
Type: Personal jet pack
Skill: Jet pack operation
Cost: 300

Availability: 4, F or R
Weight: 30 kilograms

Game Notes: Has a Move of 100 meters horizontally, 70 meters vertically. Base difficulty is Easy, modified by obstacles. Has 20 charges, can expend up to two per round. May carry an extra 100 kilograms of cargo, besides the operator, but movement is halved.

Source: Galladinium's Fantastic Technology (page 13)

Hush-About Jet Pack

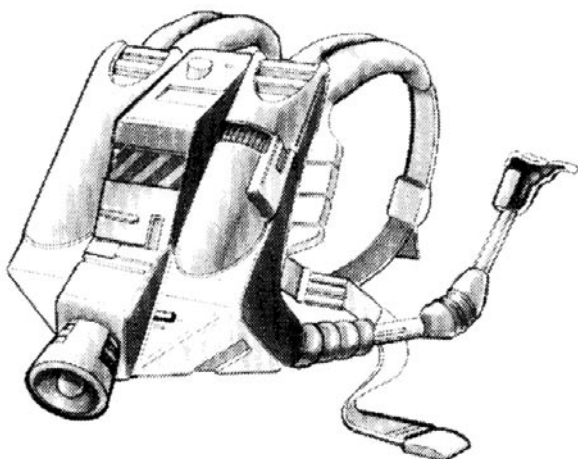

Model: Arakyd Aerodynes Inc. Hush-About AJP-400

Type: Personal jet pack

Skill: Jet pack operation

Cost: 1,800, 150 (power pack recharge), 150 (portable carrying case)

Availability: 3, F or R

Weight: 15 kilograms

Game Notes: The Arakyd Hush-About AJP-400 is capable of lifting up to 300 kilograms (total). It moves vertically 200 meters per charge, horizontally up to 500 meters per charge. A fully charged unit has 10 charges and can be run on continuous charge-feed. During normal operation this unit produces very little noise. Any attempt to locate a Hush-About using auditory pickups requires a successful *search* roll at a +10 penalty to the difficulty.

Source: Rulebook (page 226), Galladinium's Fantastic Technology (pages 11-12)

Flutter Pack

Model: Yinchorri Flutter Pack

Type: Winged thrust pack

Scale: Character

Skill: Flutter pack operation

Cost: 1,800

Availability: 4 (available only in the Yinchorr system)

Game Notes: A flutter pack contains a powerful engine attached to four lightweight, insectlike wings. Activating the pack causes the wings to flutter rapidly, providing lift and thrust. The wearer controls direction and speed using a small console built into a bracer or gauntlet. Flutter pack can lift 200 kilograms to an altitude of up to 1 kilometer, with a Move of 50. Operates for 1 hour before recharging (takes 8 hours). Comes with a set of goggles.

Source: Ultimate Alien Anthology (page 143)

Rocket Packs

Zim Systems Rocket Pack

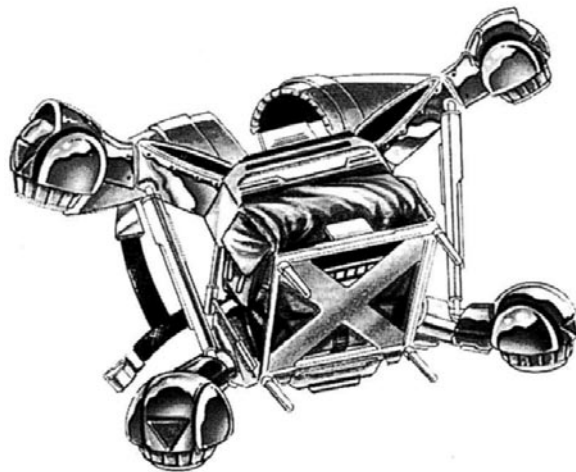

Model: Zim Systems ROCKET

Type: Personal rocket pack

Skill: Rocket pack operation

Cost: 750

Availability: 2, 3

Game Notes: The ROCKET can carry 80 kilograms up to 40 meters vertically and 120 meters horizontally on a single charge. The pack has 10 charges.

Source: Gundark's Fantastic Technology (page 68), Tales of the Jedi Companion (page 123)

Whisper Jumper Jet Pack

Model: Aratech Whisper Jumper

Type: Personal rocket pack

Skill: Rocket pack operation

Cost: 450

Availability: 3, F

Weight: 35 kilograms

Game Notes: Carries single passenger 100 meters horizontally or 70 meters vertically per jump. Fuel capacity for 5 jumps, must cool for one round after each jump.

Source: Galaxy Guide 9: Fragments from the Rim (page 9), Galladinium's Fantastic Technology (page 13)

DSP-5 Rocket Pack

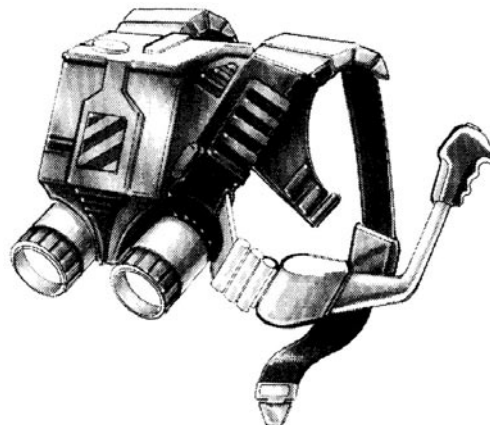

Model: Zandraman DSP-5 rocket pack

Type: Personal rocket pack

Skill: Rocket pack operation

Cost: 400

Availability: 2, R

Weight: 45 kilograms

Game Notes: The DSP-5 rocket pack can carry up to 60 kilograms and can move up to 70 meters vertically or 160 meters horizontally in a single charge. The unit has 12 charges.

Source: Rulebook (page 227)

PRP-100 Rocket Pack

Model: Presentian PRP-100

Type: Personal rocket pack

Skill: Rocket pack operation

Cost: 350

Availability: 2, R

Weight: 50 kilograms

Game Notes: Can carry up to 65 kilograms and can move up to 75 meters vertically or 170 meters horizontally in a single charge. The unit has 8 charges.

Source: Galladinium's Fantastic Technology (page 13)

RP1 Carrier Rocket Pack

Model: Fersherid RP1 Carrier

Type: Personal rocket pack

Skill: Rocket pack operation

Cost: 450

Availability: 2, R

Weight: 55 kilograms

Game Notes: Can carry up to 65 kilograms and can move up to 80 meters vertically or 180 meters horizontally in a single charge. The unit has 8 charges.

Source: Galladinium's Fantastic Technology (page 13)

HSS Thruster Pack

Model: Greshnohr

DRPV-78 Rocket Pack

Type: Rocket pack

Skill: Rocket pack operation

Cost: 600

Availability: 2, R

Weight: 65 kilograms

Game Notes: Each operation burst permits horizontal flight up to 500 meters and vertical lift up to 300 meters. Has fuel for 12 bursts, but the pack must cool for one round after each burst. Can carry 30 kilograms of cargo besides the operator. The repulsorlift generator allows the pack to hover and has a Move of 15 (cannot be used in conjunction with the rocket blast). The repulsor unit can operate continuously for a maximum of 10 minutes; it must coll for twice as long as it was operating.

Source: Galaxy Guide 10: Bounty Hunters (pages 90-91), Gundark's Fantastic Technology (pages 67-68)

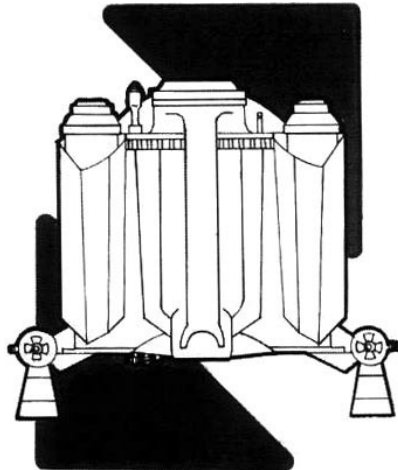

Animal Gear

Coiling Tack



Model: Swokes Swokes Coiling Tack

Type: Schinga riding saddle

Skill: beast riding

Cost: 1,000

Availability: 3

Game Notes: Provides a +1D bonus to *beast riding* when dealing with any rideable shinga or +2D if the mount is a schinga shikou. Normally used in conjunction with a Schinga Electropole.

Source: Geonosis and the Outer Rim Worlds (page 92)

Tranthebar Racing Harness

Model: leisure mechanicals

TRHA-300 Control Harness

Type: Cybernetic avian

symbiotic control harness

Skill: Beast riding:

tranthebar

Cost: 12,500; the thrantobar,

training fees, and registration

fees are separate

Availability: 4, F

Game Notes: Adds +2D to

the user's *beast riding* skill.

The TRHA control harness

is a series of external

cyber-attachments that links the

minds of the tranthebar

mountain ripper and the rider,

allowing them to share

emotions and exchange thoughts.

Source: Galladinium's Fantastic Technology (pages 90-91)

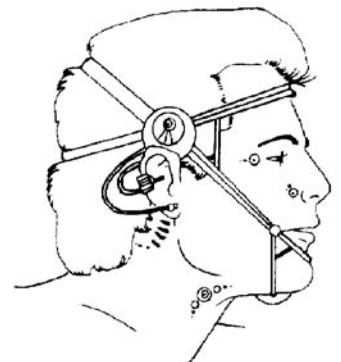

Live Organism Comfort Conveyor

Model: Kolocast Consumer Goods T-P-C4 Live Organism Comfort Conveyor

Type: Animal transport and containment system

Cost: 300 (25 kilogram size), 500 (60 kilogram size), 800 (100 kilograms size)

Availability: 2

Game Notes: Three different sizes available: small accommodates creatures up to 25 kilograms, medium up to 60 kilograms, and large up to 100 kilograms. Special orders can be made for larger needs.

Source: Galladinium's Fantastic Technology (page 14)

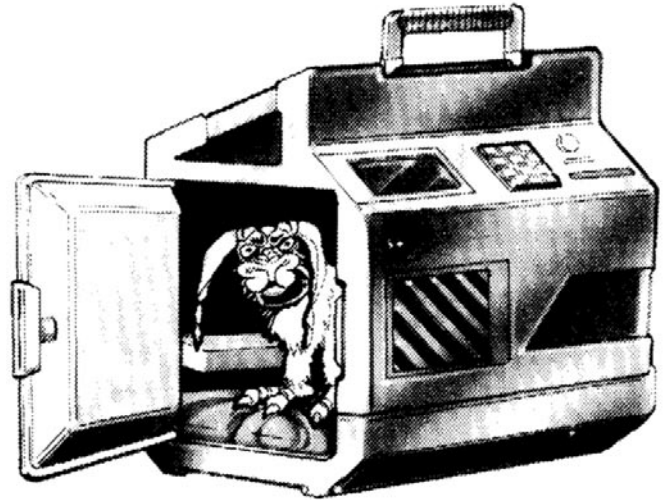

Medical

Containment Box

Model: Synthetic Medtech Corporation Irradiator Box

Type: Containment box

Cost: 500

Availability: 2

Game Notes: Containment units use a combination of broad-spectrum radiation, ultrasonics and other means to kill bacteria, viruses and microscopic nasties which might find their way onto tools or other objects.

Source: Platt's Smugglers Guide (pages 51-52)

Containment Booth

Model: Synthetic Medtech Corporation Irradiator Booth

Type: Containment booth

Cost: 2,500

Availability: 2, F

Game Notes: Containment units use a combination of broad-spectrum radiation, ultrasonics and other means to kill bacteria, viruses and microscopic nasties which might find their way onto tools or other objects.

Source: Platt's Smugglers Guide (pages 51-52)

Healing

Plasma Protein Replicator

Model: Hadrassi
Emergency Medicals
Systems Technologies
PFG-700

Type: Emergency
blood synthesizer

Skill: First aid

Cost: 5,500

Availability: 3

Game Notes: A
Difficult *first aid*
roll is required to
properly prepare
tissue and blood
sample and match it
up with local organic
samples for synthesis.

A successful operation can replicate up to 2 liters of blood substitute in one hour.

Source: Galladinium's Fantastic Technology (page 39)

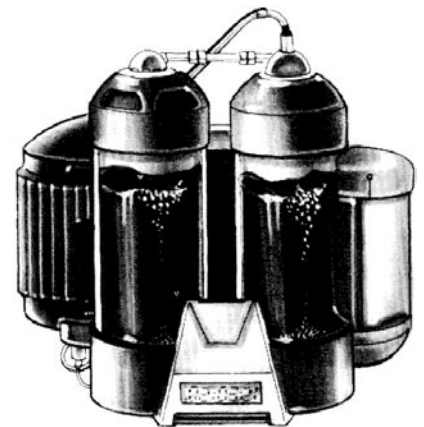

Paravacc

Model: Uukablian MedCorp Paravacc 1.X

Type: Parasite-repelling vaccine

Skill: Medicine

Cost: 1,000

Availability: 2

Game Notes: Use of the paravacc requires an Easy *medicine* roll. If successful, the vaccinated character's *Strength* is treated as 1D higher for rolls to resist diseases caused by parasites for the next 20 hours. Each paravacc holds enough medicine for 10 vaccinations. Characters using the vaccine for more than three days begin to suffer from what seems like utter exhaustion, losing one pip from each attribute for each day thereafter until the paravacc's use is ended. Each day without injection returns one pip to each attribute.

Source: The DarkStryder Campaign – The Kathol Outback (page 54)

Enzymer

Model: BioTech Mark 16 Enzymer
Type: Bio-Identification unit and counter agent producer
Skill: First Aid
Availability: 1
Game Notes: An enzymer is a device that grows and identifies biological residues and produces a counter agent to known bacteria and viruses. The enzymer can only produce counter agents to diseases and certain parasites.
Source: Adventure Journal 14 (page 59)

Vitapill

Model: Vitapill
Type: Vitality pill
Scale: Character
Cost: 25
Availability: 2
Game Notes: Vitapills are a stimulant that aids in stun recovery, with a single pill reducing the number of "stuns" a character has received by 1D+2. For each pill past the first that is taken within the same 21 hour period, this roll is modified by -2.
Source: Coruscant and the Core Worlds (page 82)

Nilar Field Caulerizer



Model: Nilar Med/Tech Corporation Field Caulerizer
Type: Field cauterizer
Skill: First aid
Cost: 200 (50 when sold to the Rebel Alliance)
Availability: 3
Game Notes: Heals minor wounds, removing stun damage due to bleeding only (gamemaster's discretion).
Source: Galladinium's Fantastic Technology (page 38), Arms and Equipment Guide (page 93)

Slick

Model: Slick
Type: Healing agent/recreational narcotic
Scale: Character
Cost: 100 credits per dose
Availability: 3, F, R, or X
Game Notes: A single dose of slick can be applied like a medpac in order to treat wounds. Slick causes a euphoric delirium in the patient, and anyone under the influence of the drug must roll a Heroic-difficulty *stamina* check or suffer a -1D penalty to their *Knowledge*, *Perception*, and *Technical* attributes for three hours.
Source: Gamer Magazine

Medpac

Type: Standard medpac
Skill: First aid
Cost: 100
Availability: 1
Game Notes: Heals one wound level on a successful *first aid* roll, being expended after that.

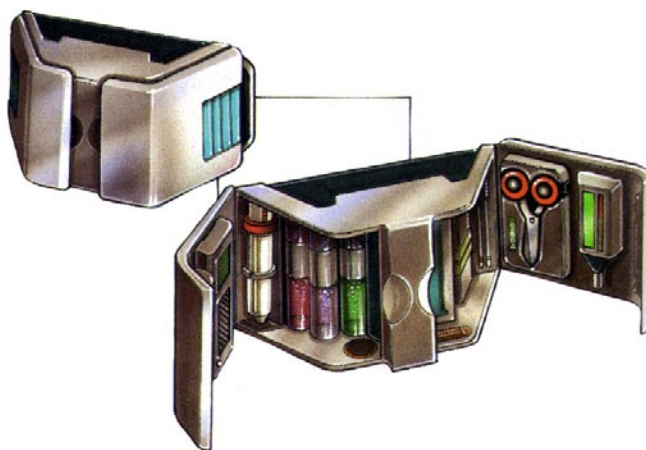

Source: Rulebook (pages 226-227), Heir to the Empire Sourcebook (page 109)

Medkit



Model: BioTech Medkit
Type: Enhanced first aid and care system
Skill: First aid, medicine
Cost: 1,200, 2,200 (black market), 1,000 to reload medpacs
Availability: 2
Game Notes: A medkit functions as a medpac that can be used up to 10 times. The diagnostic instruments in the kit can also be used to diagnose diseases afflicting a patient, to assess health, and for other basic medical uses on an *Easy first aid* roll. The kit also allows a character with the *medicine* advanced skill to perform field surgery (which exhausts the kit's medpacs)
Source: Gundark's Fantastic Technology (page 82), Pirates & Privateers (page 47)

FastFlesh Medpac

Model: VioTech FastFlash Medpac
Type: Advanced medpac
Skill: First aid
Cost: 500
Availability: 2
Game Notes: Use the following difficulties for FastFlesh medpacs:

<i>Wounded</i>	5
<i>Incapacitated</i>	10
<i>Mortally Wounded</i>	15

Can only be used once per day on a patient. Can be used in conjunction with regular medpacs. If used more than once per day, the character suffers a mortally wound *in addition to the wounds he or she may already have incurred*; this is usually fatal.

Med-Aid

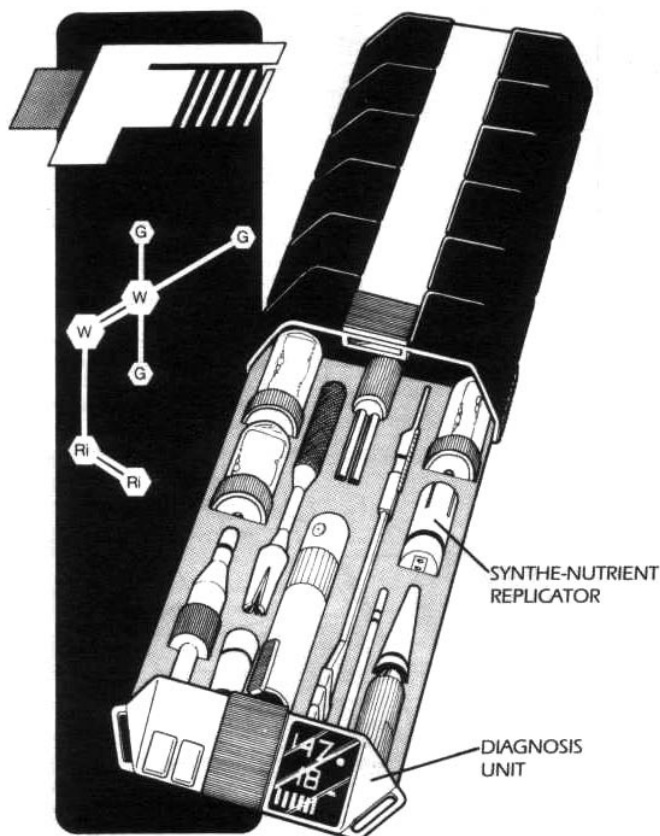

Source: Cracken's Rebel Field Guide (page 15), Rules of Engagement – The Rebel SpecForce Handbook (pages 39-40), Arms and Equipment Guide (pages 92-93)



Model: Jassim Design QuickMed

Type: Emergency medical kit

Skill: First aid

Cost: 250

Availability: 1

Game Notes: Med-aids convey a +1D bonus to any *first aid* skill rolls. Each med-aid may be used only once.

Source: Gundark's Fantastic Technology (page 82), Tales of the Jedi Companion (page 123)

Spray Plasto-Cast

Model: SyntheCure Plasto-Cast

Type: Spray immobilizing cast

Skill: First aid

Cost: 35

Availability: 1

Game Notes: An Easy *first aid* roll is required for proper application; each pistol has one application and cannot be refilled. Effect is to add +2 to the character's next healing roll. Adjustments to emission tip controls width of spray. One plasto-cast contains sufficient chemical adherent to cover a surface area approximately 50 centimeters by 20 centimeters. In emergency situations, a Moderate *survival* roll may be substituted for the *first aid* roll.

Source: Galladinium's Fantastic Technology (page 41)

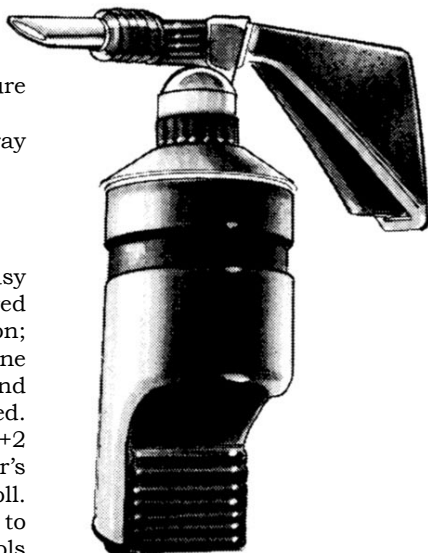

Bacta Geltab

Model: Genetech G-5 Geltab

Type: Medpac treatment enhancer

Skill: Dexterity

Cost: 50 (for pack of six)

Availability: 1

Game Notes: By applying a bacta geltab to a wound, and making a Very Easy *Dexterity* roll, the user gains a +1D bonus on the following *first aid* roll using a medpac on the treated wound.

Source: Lord of the Expanse – Sector Guide (page 45)

Trauma Kit

Model: Imperial-issue Medical Resources Kit

Type: Trauma medpac

Scale: Character

Skill: First aid

Cost: 200

Availability: 1, F

Game Notes: Provides +1D to *first aid* or *medicine* when used to treat severe physical trauma, such as burns, cuts, contusions, abrasions and other external physical injuries.

Provides no bonus for other types of injury (such as internal injuries) or the treatment of toxins or poisons.

Source: The DarkStryder Campaign – The Kathol Rift (page 90)

Customized Medical Backpack

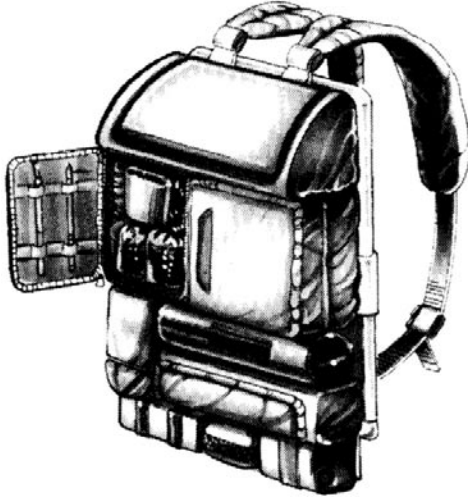

Model: Chiwab Amalgamated Pharmaceuticals Company ECM-598

Type: Advanced medical kit

Skill: First aid

Cost: 600

Availability: 2

Game Notes: Treat all components as requiring an Easy *first aid* roll unless otherwise noted. Each kit contains the following items:

-*Hand-Held Diagnostic Scanner:* Easy *first aid* or Moderate *sensors* roll. Provides readout of patient's vital signs, specifics on injury and recommended procedures.

-*Medicines:* Anesthetics, blood pressure, respiration and pulse regulation compounds, as well as other essential medicines (for a number of common species).

-*Emergency Procedures Database:* Easy *computer programming/repair* roll. Based on initial scanner findings, this emergency database provides the user with a quick-reference collection of treatment procedures.

-*Filtration Mask:* Supplies sufficient oxygen flow; may also be connected to one of several atmospheric compound bottles for non-oxygen breathers.

-*Heat Closure Packs:* Pressurized sealant bandages with medicines which, when exposed to air, cauterize and sterilize a wound up to 10 centimeters in diameter.

-*Laser Scalpel:* Difficult *first aid* roll. Precision cutting tool.

-*Medicine Dispenser:* Moderate *first aid* roll. Can be loaded with a variety of medicines.

-*Portable Repulsor-Stretcher:* Collapsible one-person operation anti-grav stretcher capable of supporting up to 150 kilograms.

-*Pressure Cuffs:* Circular metal sleeves of varying diameter (5-30 centimeters) which inflate pressurized chambers around wound area.

-*Sterile Heating Cloth:* Covers an area up to 1.6 meters x 0.75 meters with a sterilized, heat-insulated covering.

-*2 Universal Plasma Fluid Sacks:* Require Moderate *first aid* roll. Intravenous feed provides universal plasma stabilization serums.

Source: Galladinium's Fantastic Technology (pages 38-39), Rules of Engagement – The Rebel SpecForce Handbook (page 39), Arms and Equipment Guide (page 93)

Abyssin Grafting Patch

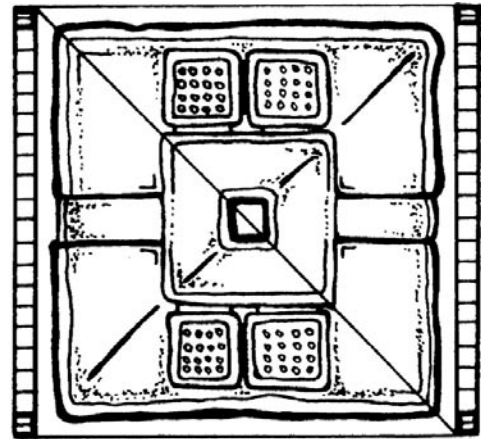

Model: Kirgalis Pharmaceutical Exports Abyssin Grafting Patch

Type: Regenerative grafting patch

Skill: First aid or medicine

Cost: 5,000

Availability: 3

Game Notes: A Difficult *first aid* or Easy *medicine* roll is required for normal application. As with bacta tanks, the patient *will* heal if allowed to rest, but the healing time depends upon the severity of injury.

Character is: **Treatment time:**

Wounded 2D hours

Incapacitated 8D hours

Mortally Wounded 2D days

After a patch is used once, it is all used up and new patches must be bought. Many lifeforms with natural regenerative abilities have a high resistance to the effects of this patch.

Source: Galladinium's Fantastic Technology (page 85)

Med Unit

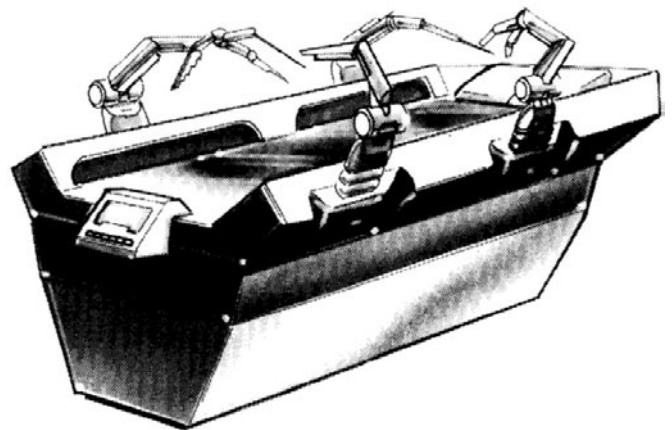

Model: Athakam II Med Unit

Type: Portable medical unit

Cost: 3,000

Availability: 2

Game Notes: Device can diagnose and treat common diseases and poisons, in addition to stabilizing a seriously injured patient. Has *first aid* 5D and *medicine* 1D. A medical droid may interface with the med unit, receiving a +2D bonus to *first aid* and +1D to *medicine*.

Source: Galladinium's Fantastic Technology (page 40), Arms and Equipment Guide (page 92)



Bacta Tank

Model: Zaltin and Xucphra Corporation Bacta Tank

Type: Bacta tank

Scale: Character

Skill: Medicine or First aid

Cost: 3,000

Availability: 2

Game Notes: Fully heals a patient on a successful Very Easy *medicine* or Heroic *first aid* roll. Healing time is 1D hours for Wounded patients, 4D hours for Incapacitated and 1D days for Mortally Wounded. If the roll fails, patient's injury worsens two levels.

Source: d20 Core Rulebook (page 140)

Stabilizing

Replar Splint

Model: Xarnin Medical Technologies GRS-600

Type: Field splint

Skill: First aid

Cost: 200

Availability: 2

Game Notes: An Easy *first aid* roll is required for normal placement. This is increased to Moderate level for multiple or compound fractures. Once activated, limited movement is possible.

Source: Galladinium's Fantastic Technology (page 40)



Sluissi Gravitic Pressure Bandage

Model: Slusani Interstellar Pharmacologies SGB-543

Type: Micro-gravity pressure patch

Skill: First aid

Cost: 750

Availability: 2

Game Notes: An Easy *first aid* roll is required for proper placement and will allow Wounded patients to act as if

unwounded or Incapacitated patients to act as Wounded (the injury is still there, but the patient will be able to move and so forth). It is up to the gamemaster to require players to properly roleplay the effects of this device.

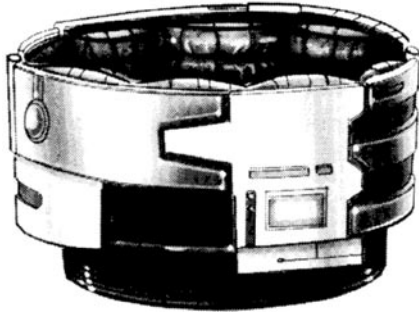

Source: Galladinium's Fantastic Technology (pages 40-41)

Bacta Tray

Model: Genetech BT-16 Bacta Tray
Type: Mobile medical stabilization unit
Skill: First aid
Cost: 2,200
Availability: 2

Game Notes: Activating a bacta tray requires an Easy *first aid* roll. If successful, the patient's mortally-wounded status remains unchanged until a time as the patient can undergo full bacta treatment.

Source: Lord of the Expanse – Sector Guide (page 45)

Anti-Shock Blanket

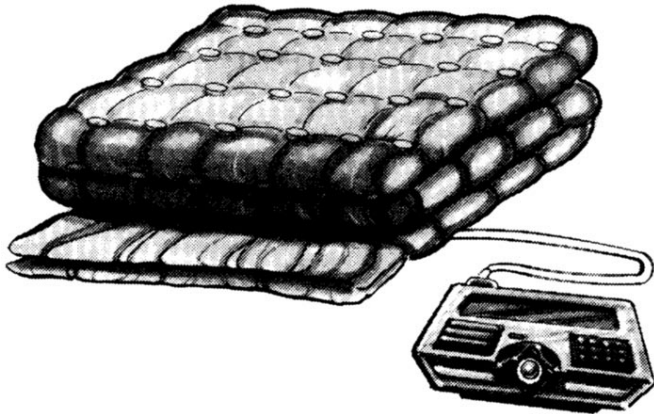

Model: Fabreth Medical Biochemicals Shock Cloth
Type: Emergency blanket
Skill: First aid
Cost: 250
Availability: 2

Game Notes: When attached to a medical scanner, computer, or datapad (not included), a shock cloth can prevent shock by administering medication to different parts of a patient's body while simultaneously stabilizing his temperature. This results in a +2D bonus to any *first aid* or (A) *medicine* skill rolls made to stabilize a wounded, dying, or incapacitated character. A *first aid* roll is required for normal application (use medpac rules, but reduce difficulties by one level). The blanket's medicines must be replenished after one use (normally costs about 20-40 credits).

Source: Galladinium's Fantastic Technology (page 38), Arms and Equipment Guide (page 93)

Portable Survival Pod

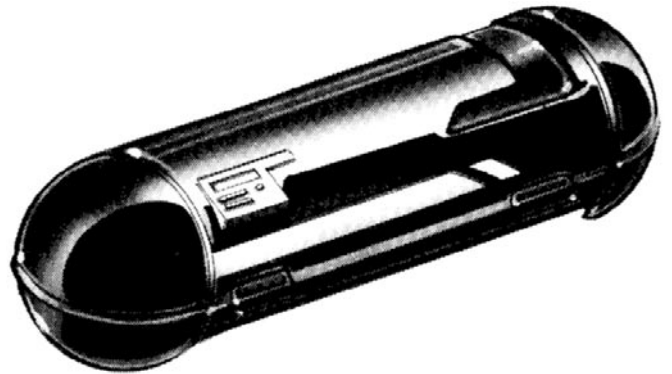

Model: Praxen Emergency Medical Supplies, Limited PSP-278

Type: Emergency survival pod
Skill: First aid; computer programming/repair
Cost: 13,500

Availability: 3
Game Notes: Easy *computer programming/repair* and Moderate *first aid* roll to activate for an Incapacitated or Wounded patient. Moderate *computer programming/repair* and Difficult *first aid* roll to activate for a Mortally Wounded patient. Successful activation means that the patient will remain in current physical condition (will not worsen) as long as power is supplied from a generator to the pod.

Source: Galladinium's Fantastic Technology (page 40)

Hyperbaric Medical Chamber

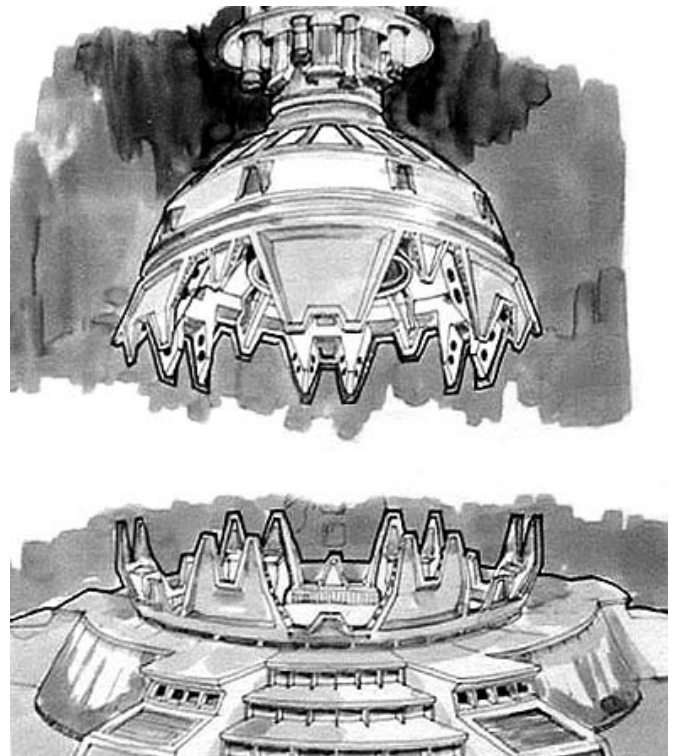

Model: Athakam/RSMA Atmosphere Replicator
Type: Hyperbaric medical chamber
Scale: Character
Cost: 50,000
Availability: 3, F

Game Notes: The chamber's atmosphere can be adjusted to allow comfortable habitation for any species or medical conditions patient may have. This negates any penalties and the need for life-support apparatus while in the chamber.

Source: Shadows of the Empire Sourcebook (page 112)

Celegian Life-Support Chamber

Model: Celegian Life-Support Chamber

Type: Cyanogen gas chamber

Cost: 6,000

Availability: 4

Game Notes: Chamber provides full cover to its occupant and has a *Strength* of 5D to resist damage. If destroyed, it releases a 10-meter-radius cyanogens gas cloud that deals a temporary -1D *Strength* penalty to non-cyanogen breathers in the area who fail a Moderate *stamina* roll each round of exposure. The cloud dissipates in 1 round if not confined.

Source: Ultimate Alien Anthology (page 30)

Medical Scanners

Med Diagnostic Scanner

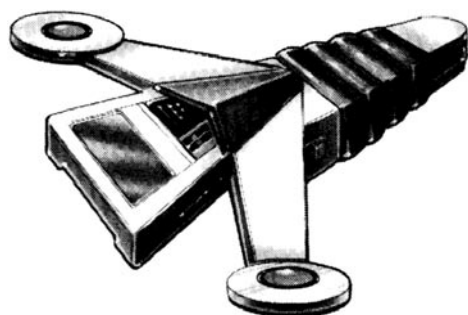

Model: Synthetic Medtech Corporation MDS-50

Type: Personal medical scanner

Skill: First aid

Cost: 75

Availability: 1

Game Notes: An Easy *first aid* roll will provide basic readouts relating to the patient's overall physical condition, Moderate *first aid* roll required to scan for specific ailment. Device will not make recommendations for treatments, but will identify current physical abnormalities and suggest probable causes. Difficulties should be adjusted for unusual or hard to detect conditions.

Source: Galladinium's Fantastic Technology (page 39), Arms and Equipment Guide (page 93)

Medscanner

Model: Cryoncorp Mediscan 21

Type: Medscanner

Cost: 3,000

Availability: 2

Game Notes: The difficulty level for using this scanner is the same as that for using a medpac - Easy for Wounded, Moderate for Incapacitated and Difficult for Mortally Wounded characters. Successful use of a medscanner adds 1D to *first aid* rolls.

Source: Gundark's Fantastic Technology (pages 103-104)

Bioscan

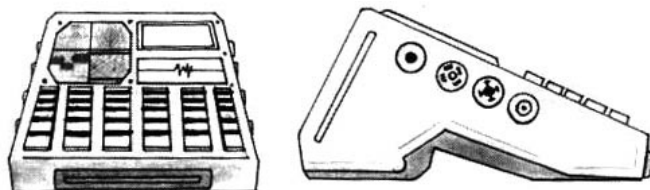

Model: Athakam/RMSA Bioscan Unit

Type: Bioscan

sensor array and analysis unit

Scale: Character

Skill: Computer programming/repair (set up); first aid or medicine to use

Cost: 13,000

Availability: 3, F

Game Notes:

Requires an Easy to Difficult *computer programming/repair* roll to set up (depending on situation). If

properly set up, adds +2D to *first aid*, *medicine* or *Technical*.

Maximum range of three meters.

Source: Gundark's Fantastic Technology (page 101), Shadows of the Empire Sourcebook (page 110)

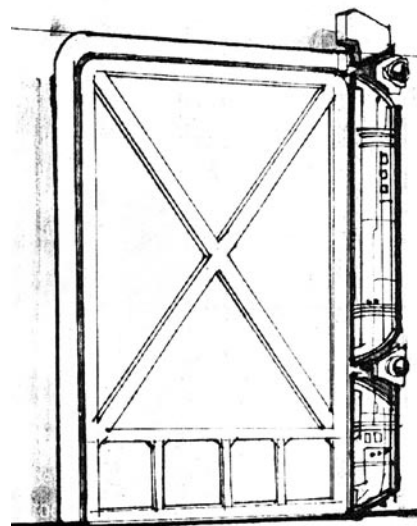

Medisensor

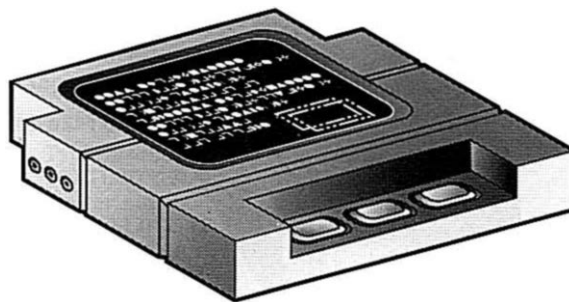

Model: BioTech RFX/K Medical Sensor Supplement

Type: Portable medical diagnostic relay

Skill: First aid

Cost: 5,000

Availability: 2

Game Notes: Medisensors are used to augment the diagnostic scanner of a medical bay. Since they can access the medical database of a standard medbay, they are basically booster relays for the existing system. (Access range from database medical computer is 2 kilometers for military-issue units, 300 meters for civilian units). Anyone using a medisensor receives a +2D bonus to *first aid* checks. However, a medisensor that is not patched into a medbay's computer only delivers a +1D bonus.

Source: Gundark's Fantastic Technology (page 103), Rules of Engagement - The Rebel SpecForce Handbook (page 39), The Truce at Bakura Sourcebook (page 138), Arms and Equipment Guide (page 93)

Drugs

Signature Scent Synthesizer

Model: Paradour Enterprises Signature Scent Synthesizer

Type: Computerized fragrance synthesizer and replicator

Cost: 1,500, 150 (refills)

Availability: 3

Game Notes: Some fragrances may contain biological ingredients (such as pheromonal additives) that may induce an exceptionally strong effect on some beings. In game terms, "victims" of such pheromonal fragrances might suffer penalties to *willpower* rolls to avoid infatuation or resist the effect of *command*, *con*, *persuasion* and similar skills. Enterprising characters with the appropriate chemistry background may concoct all kinds of substances with a number of psychological effects.

Source: Galladinium's Fantastic Technology (page 46)

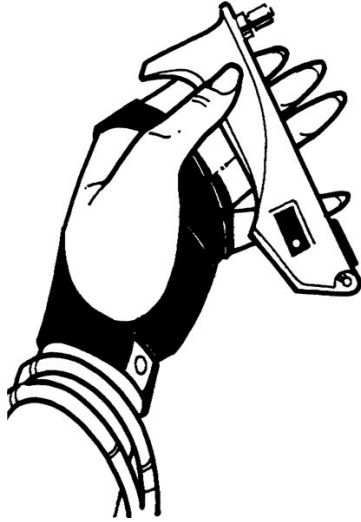

Orfite Scent Mask



Model: Orfa Olfactory Corporation Scent Mask

Type: Recreational olfactory scent mask

Cost: 200 (400 off Kidron)

Availability: 2

Game Notes: The apparatus consists of a breath mask connected by a tube to a small belt unit, which holds about half a liter of water. A small tablet is inserted into the unit and the belt creates a mist that travels up the tube into the breath mask. Scent tablets are five credits apiece, while intoxicant tablets are ten credits each.

Source: Planets Collection (page 150)

Elixir of Infatuation

Model: Zeltron Elixir of Infatuation

Type: Mind-affecting drug

Cost: 250 (per vial)

Availability: 3

Game Notes: A creature that imbibes the transparent, odorless liquid becomes infatuated with the first creature he or she sees afterwards. The mind-influencing effect lasts for 1D hours, and a successful Difficult *willpower* roll negates the effect. If the drinker and the source of the infatuation are of the same species, apply a -1D+1 penalty to the drinker's roll. If both are human or near-human, but of different species, apply a -2 penalty to the roll instead. Creatures with Dark Side Points or immune to mind-influencing effects are immune to the elixir. An infatuated creature suffers a -2D penalty to *Perception*-based rolls regarding the source of infatuation. If this source threatens the infatuated creature in any way, the victim gets another *willpower* roll to negate the elixir's effect.

Source: Ultimate Alien Anthology (page 197)

Cyduct Chemical Booster

Model: Seselin Medicinal Electronics Cyduct E-23 Booster

Type: Interdermal injection system

Skill: First aid

Cost: 1,250

Availability: 3, F, R or X

Game Notes: An Easy *first aid* roll is required for first time set up. A variety of different chemical compounds are available from physicians by prescription. The booster holds up to 10 doses.

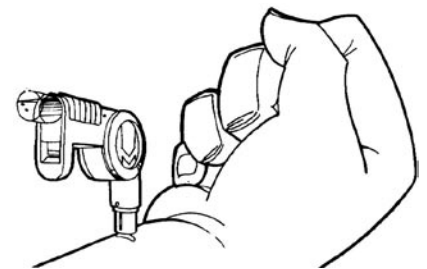

Serum	Cost/Dose	Duration	Comments
DiMatolin	100	1 hour	Negates <i>Dexterity</i> penalties in high gravity environments (up to 1.4 standard gravities)
Elisinandrox	250	10 hours	+1D+1 to <i>Strength</i> or <i>stamina</i> to resist radiation sickness
Gresholl-polyforim	150	3 hours	Negates <i>Strength</i> penalties in high-gravity environments (up to 2 standard gravities)
Haladreshin	200	8 hours	+1D to <i>Perception</i> and related skills; effective as neurological stimulant
Requilisant	200	6 hours	Negates <i>Dexterity</i> related penalties in low and zero gravity environments

Source: Galladinium's Fantastic Technology (pages 43-44)

Ryll Spice

Model: Ryloth Spice

Type: Narcotic

Cost: 100-250 per kilogram

Availability: 2, R (legal on Ryloth)

Game Notes: Ryll spice has little effect on beings other than euphoria and interesting, sometimes disturbing, hallucinations. However, when used in excess, it can be a dangerous and addictive drug which stimulates (and sometimes burns out) the pleasure centers of most species brains.

Source: Shadows of the Empire Planets Guide (page 41)

Andris White Spice

Model: High-Grade White Sevari Spice

Type: Sense-enhancing drug

Cost: 500 per dose

Availability: 3, R

Game Notes: High-quality andris can be ingested directly, dissolved under the tongue, or taken with food. A dose increases *Perception* scores by +1D for one hour. Due to the increased sensitivity, damage done to the character while under the influence of the spice is increased by +1D.

Source: Shadows of the Empire Planets Guide (page 40), Adventure Journal 2

Carsunum Black Spice

Model: Black Sevari Spice

Type: Physical-enhancing drug.

Cost: 1,000 per dose

Availability: 4, X

Game Notes: Carsunum users become more intelligent, faster, stronger, and generally more able. Users also experience a mild euphoria and increased confidence. This benefit has a dark side: after the effect wears off, users become listless, sometimes poisoned, and occasionally overdose fatally. Carsunum increases all abilities and skills by +1D for 1D hours. At the end of the effect, the user takes 1D damage for each hour under the influence (the carsunum bonus cannot be applied). Force skills and bonuses from Force Points are decreased by -1D per dose for the appropriate period.

Source: Shadows of the Empire Planets Guide (page 40), Adventure Journal 2

Glitterstim Spice

Model: Kessel Glitterstim Spice

Type: Telepathic booster drug

Cost: 6,000-10,000 per dose

Availability: 4, X

Game Notes: Glitterstim is sealed into slim black cylinders. To activate the spice, one pulls back the opaque outer wrapper, exposing the inert glassy fibers of the spice to the light. As the spice reacts to the light, scintillating and glowing from within, it ripens. When the transparent fibers glow a pearlescent blue, they are ready to consume. The consumer takes the spice orally, which dissolves in his or her mouth with a crackling and faint show of tiny sparks. Characters imbibing glitterstim are considered Force-sensitive for 10 rounds. During this time, they can read the surface thoughts of a target person. This functions like the Receptive Telepathy Force power, except that the

user is restricted to using his or her Perception to make the difficulty roll. Those who already have the Force power derive no benefit from using glitterstim.

Source: The Jedi Academy Trilogy Sourcebook (page 86), Shadows of the Empire Planets Guide (page 40)

Death Stick



Model: Ixetal Cilona Extract Drug (fluid or solid)

Type: Narcotic

Availability: 3, X

Game Notes: Users experience a temporary explosion of bliss. Anyone who samples a death stick must make a Difficult *willpower* skill check. If failed, the character suffers a -1D penalty to both his *Dexterity* and *Knowledge* attributes. After 1-2 hours, the effects wear off, and the character must attempt a Very Difficult *Strength* check. Failure indicates addiction and the loss of -1 pips of *Strength* (which is permanent, unless treated). Anyone wishing to break their addiction can seek treatment, but this is costly. At the GM's option, lost points of *Strength* can be recovered by using the (A) *medicine* skill (difficulty equal to 20, +1 per lost point of *Strength*), or the Accelerate Healing or Accelerate Another's Healing Force powers.

Source: Coruscant and the Core Worlds (page 18)

Boosters

Emotion Suppressant

Model: Consolidated Learning Systems Model ES23

Type: Emotion suppression system

Cost: 750

Availability: 3

Game Notes: Device uses micro-powered cells. Each pair must be worn a minimum of 24-30 hours to allow for proper calibration to the wearer's life function rhythms. Device adds +2D bonus to any *willpower* rolls to resist emotional-impulses. Note that this device could conceivably be used to help resist torture (although it has no effect on resisting Force abilities).

Source: Galladinium's Fantastic Technology (pages 36-37)

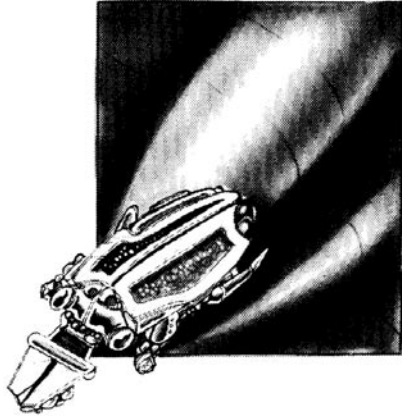

Orfite Power Harness

Model: Orfa Toolco Power Harness

Type: Strength enhancer

Cost: 800

Availability: 3

Game Notes: Negates penalties for Orfites (and other low-gravity species) on standard gravity worlds.

Source: Planets Collection (page 150)

Servo Slippers

Model: Mahled Medical Services Servo Slippers

Type: Repulsorlift assisted leg and arm braces

Cost: 2,500 per pair (foot/leg or hand/arm)

Availability: 3

Game Notes: On high gravity worlds, foot/leg braces alone negate Movement penalties and cut *Dexterity* penalties by two pips. Hand/arm braces

alone cut *Dexterity* penalties by two pips. Both foot/leg and hand/arm braces completely negate all *Dexterity* penalties.

Source: Galladinium's Fantastic Technology (page 45)

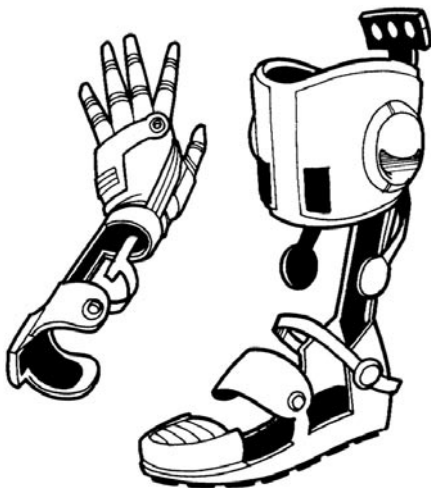

Grav Mill

Model: Quarlitech Aergronics, Inc. GRGC-800

Type: Grav treadmill incline

Cost: 700

Availability: 2

Game Notes: Dedicated training on the grav mill for an extended period of time (anywhere from a few days to weeks, depending upon the severity of gravity change) can help eliminate any penalties due to higher or lower gravity worlds.

Source: Galladinium's Fantastic Technology (page 31)



Myostim Unit

Model: Traxes BioElectronics Myostim Couch

Type: Myostim unit

Scale: Character

Cost: 30,000

Availability: 3

Game Notes: For every 12 hours spent on a myostim unit the subject's *Strength* is increased by +1 (maximum bonus of +1D). The bonus lasts for one week. Extended use of myostim unit might have psychologically damaging results in tense situations requiring sudden bursts of activity. After more than six months of use, characters in an extremely stressful situation may suffer a -2 penalty to *Dexterity*, *Knowledge*, *Perception*, and all related skills, with a mishap, the character becomes enraged and uncontrollable.

Source: Gundark's Fantastic Technology (pages 109-110), Shadows of the Empire Sourcebook (pages 112-113)

Cybernetics

Replacement Prosthetics

Model: BioTech Repli-Limb Prosthetic Replacements
Type: Cybernetic prosthetics
Cyber Points: 1 per replacement
Cost: The following costs include the basic prosthetic and operation:

- Hand 1,000 credits
- Arm 2,000 credits
- Leg 2,000 credits
- Knee 1,200 credits
- Eye 2,750 credits
- Ear 2,750 credits
- Heart 5,000 credits
- Kidney 4,500 credits
- Lungs 4,000 credits

Availability: 4

Game Notes: The prosthetic is almost completely lifelike – a Difficult *Perception* roll is needed to tell the part from an organic one. The replacement has no special abilities.

Source: Cracken's Rebel Field Guide (page 29), Heir to the Empire Sourcebook (pages 109-110), Pirates & Privateers (pages 50-51)

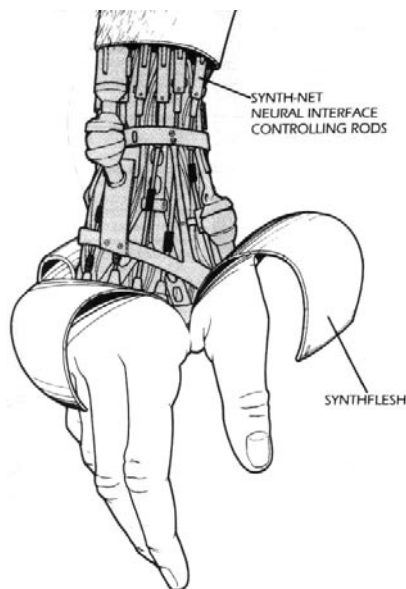

Cybernetic Hand

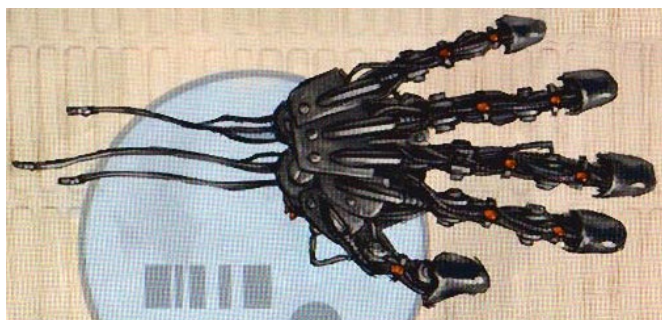

Type: Prosthetic limb
Scale: Character
Skill: Medicine: cyborging (to install)
Cost: Varies by model
Availability: 2, R
Difficulty: To install: Difficult (+1 hand), Very Difficult (+2 hand)

Game Notes: If the *medicine* roll to install fails by less than 5 points, the limb has a side effect (listed below). Item bonus refers to attribute-based actions related to that limb only.

Bonus	Price	Surgery	Side Effects
+1 <i>Strength</i>	2,000	6,000	-1D <i>Dexterity</i> with hand
+2 <i>Strength</i>	5,000	15,000	-2D <i>Dexterity</i> with hand
+1 <i>Dexterity</i>	2,000	6,000	-1D <i>Strength</i> with hand
+2 <i>Dexterity</i>	5,000	15,000	-2D <i>Strength</i> with hand

Source: Hero's Guide (page 129)

Cybernetic Forearm

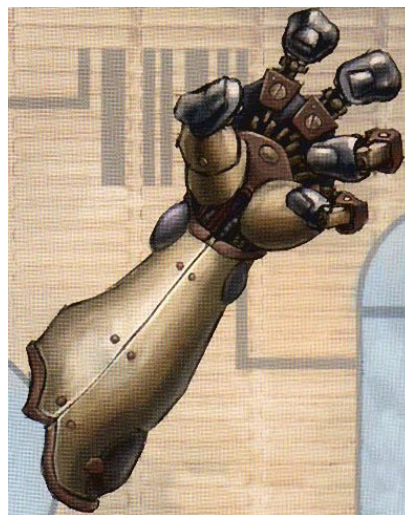

Type: Prosthetic limb
Scale: Character
Skill: Medicine: cyborging (to install)
Cost: Varies by model
Availability: 2, R
Difficulty: To install: Moderate (+1 forearm), Difficult (+2 forearm)
Game Notes: If the *medicine* roll to install forearm fails by less than 5 points, the limb has a side effect (listed below). Item bonus refers to attribute-based actions related to that limb only.

Bonus	Price	Surgery	Side Effects
+1 <i>Strength</i>	3,000	9,000	-1D <i>Dexterity</i>
+2 <i>Strength</i>	7,500	22,500	-2D <i>Dexterity</i>

Source: Hero's Guide (page 129)



Cybernetic Arm



Type: Prosthetic limb
Scale: Character
Skill: Medicine: cyborging (to install)
Cost: Varies by model
Availability: 2, R
Difficulty: To install: Moderate (+1 arm), Difficult (+2 arm)
Game Notes: If the *medicine* roll to install arm fails by less than 5 points, the limb has a side effect (listed below). Item bonus refers to attribute-based actions related to that limb only.

Bonus	Price	Surgery	Side Effects
+1 <i>Strength</i>	4,000	12,000	-1D <i>Dexterity</i>
+2 <i>Strength</i>	10,000	30,000	-2D <i>Dexterity</i>

Source: Hero's Guide (page 129)

Cybernetic Knee

Type: Prosthetic limb
Scale: Character
Skill: Medicine: cyborging (to install)
Cost: Varies by model
Availability: 2, R
Difficulty: To install: Easy (+1 knee), Moderate (+2 knee)
Game Notes: If the *medicine* roll to install knee fails by less than 5 points, the limb has a side effect (listed below). Item bonus refers to attribute-based actions related to that limb only.

Bonus	Price	Surgery	Side Effects
+1 <i>Strength</i>	1,500	4,500	3/4 Move
+2 <i>Strength</i>	4,000	12,000	1/2 Move

Source: Hero's Guide (page 129)

Cybernetic Leg

Type: Prosthetic limb
Scale: Character
Skill: Medicine: cyborging (to install)
Cost: Varies by model
Availability: 2, R
Difficulty: To install: Moderate (+1 leg), Difficult (+2 leg)
Game Notes: If the *medicine* roll to install leg fails by less than 5 points, the limb has a side effect (listed below). Item bonus refers to attribute-based actions related to that limb only.

Bonus	Price	Surgery	Side Effects
+1 <i>Strength</i>	3,000	9,000	1/2 Move
+2 <i>Strength</i>	6,500	19,500	1/4 Move

Source: Hero's Guide (page 129)

Cybernetic Legs Package

Type: Prosthetic limbs
Scale: Character
Skill: Medicine: cyborging (to install)
Cost: Varies by model
Availability: 2, R
Difficulty: To install: Moderate (+2 leg), Difficult (+4 leg), Very Difficult (+6 leg)
Game Notes: If the *medicine* roll to install legs fails by less than 5 points, the limb has a side effect (listed below).

Bonus	Price	Surgery	Side Effect
+2 Move	4,000	12,000	2D damage per use
+4 Move	9,000	27,000	3D damage per use
+6 Move	18,000	54,000	4D damage per use

Source: Hero's Guide (page 129)

Skeletal Reinforcement

Model: BioTech Superstruct Skeletal Reinforcement
Type: Skeleton reinforcement
Scale: Character
Skill: Medicine: cyborging (to install)
Cost: 10,000 (surgery: 50,000)
Availability: 2, R
Difficulty: To install: Heroic
Game Notes: Subject gains +1D to resist physical damage. If the *medicine* roll to install fails by less than 5 points, subject suffers a -1D penalty to *Strength*-based actions. This cannot be recovered until the cybernetic component is removed.
Source: Hero's Guide (pages 130-131)

Cardio-Muscular Package

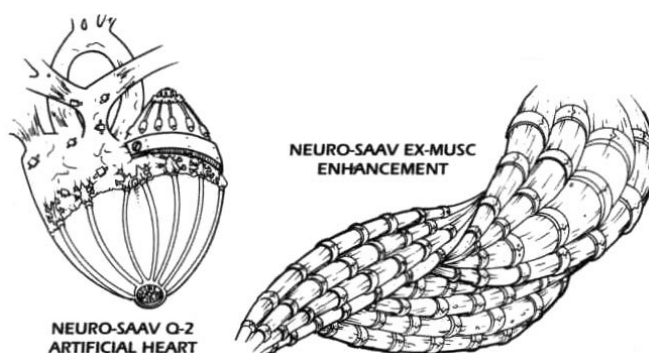

Model: Neuro-Saav Corporation Cardio-Muscular Package
Type: Increases Strength attribute/skills
Cost: 800 credits per pip
Cyber Points: 2
Game Notes: Operation takes one week. Recipient must spend another week recovering and adjusting to new implants. Doctor must make three Difficult *medicine* rolls over the week of the operation for successful implantation. If any of the rolls fail whenever the character makes a Difficult or Very Difficult *Strength* or associated roll, the character must make a second Difficult *Strength* roll. If this second roll fails, the character muscles contract and the character falls prone for 2D minutes.
Source: Cracken's Rebel Field Guide (page 35)

Response Improvement Package

Model: 'Geneering Response iMprOVEMENT Package (RiMPack)
Type: Increases Dexterity attribute/skills
Cost: 700 credits per pip
Cyber Points: 2
Game Notes: To install, doctor must make three Difficult *medicine* rolls over the week of the operation for success. If any of the rolls fail, the character becomes highly agitated, or *hyperactivates*, whenever he rolls a 20 or higher with a Dexterity skill. During hyperactivation, the character is overwhelmed with sensory input for 2D minutes and is controlled by the gamemaster. The character may attack friends or foes, flee the scene or be hypnotized with fear.
Source: Cracken's Rebel Field Guide (page 36)



Hifold Sensory Package



Model: Neuro-Saav Hifold Sensory Package
Type: Increases Perception attribute/skills
Cost: 400 credits per pip
Cyber Points: 2
Source: Cracken's Rebel Field Guide (page 38), Hero's Guide (page 131)



Source: Hero's Guide (pages 129-130)

Hi-Sense Enhanced Eyes

Model: Neuro-Saav Hi-Sense Enhanced Eyes
Type: Enhanced IR and UV eyes
Cost: 100 credits per pip
Cyber Points: 2
Game Notes: Increases recipient's search skill. Base cost is 100 credits per pip of existing skill code, plus 200 per pip of enhancement.
Source: Cracken's Rebel Field Guide (page 39)

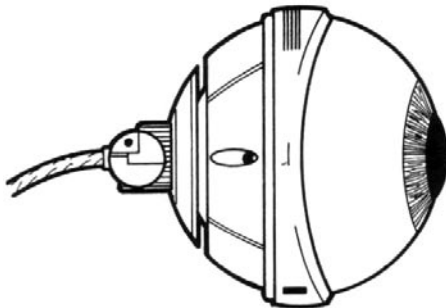

Motion Interface Package

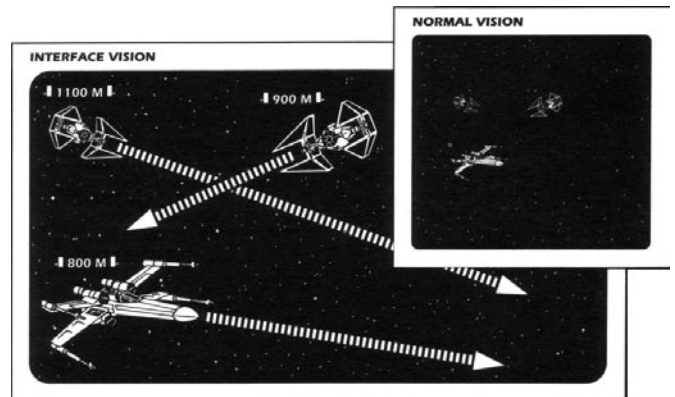

Model: SoroSuub Motion Interface Package
Type: Increases Mechanical attribute/skills
Cost: 400 credits per pip
Cyber Points: 2
Source: Cracken's Rebel Field Guide (page 37)

Cybernetic Eye

Type: Prosthetic eye
Scale: Character
Skill: Medicine: cyborging (to install)
Cost: Varies by model
Availability: 2, R
Difficulty: Moderate (to install)
Game Notes: If the *medicine* roll to install eye fails by less than 5 points, the limb has a side effect (listed below).

Item	Bonus	Price	Surgery	Side Effect
Flare Suppressor	Can't be flash-blinded	250	1,900	-1 on attack rolls
IR Sensor	Darkvision to 30m	300	2,250	Blinded by nearby heat sources
Optical Enhancer	+1D to <i>search</i>	450	3,400	-1D to ranged attacks
Targeting Eye	+1 on ranged attacks	500	3,750	-1D to <i>search</i>
Telescopic Eye	Reduced <i>search</i> ranges	500	3,750	-1D to <i>search</i>

Ultrasound Sight Enhancer

Model: Traxes BioElectronics Ultrawave Sight Enhancer

Type: Ultrasonic wave motion sensory system

Cost: 12,500; does not include cost of implantation surgery

Availability: 4

Game Notes: Sensory motion system implant feeds input directly into the user's brain, creating a three-dimensional, black and white, sonic graph of the user's surrounding. An Easy *sensors* total is required

to properly calibrate wave receptors once implantation nodes are in place. Otherwise, a Very Easy *Perception* roll is required periodically (varies according to species) for normal use. Normal operating range is 50 meters and function is equally good in all environmental conditions excepting those involving severe electrical disturbances.

Source: Galladinium's Fantastic Technology (page 37)



hardware into non-Neimoidians without a sufficient bribe. However, since the technology is made specifically for Neimoidians, any character of another species loses twice as much *Knowledge* and *Perception* (ie, +4 pips/1D+1) due to the installation.

Source: Secrets of Naboo (page 17)

Tremor Sensor

Type: Cyber sensor

Scale: Character

Skill: Medicine: cyborging (to install)

Cost: 400 (surgery: 3,750)

Availability: 2, R

Difficulty: To install: Difficult

Game Notes: Foot sensor picks up sonic vibration, allowing the character to detect the presence of anything within 20 meters if it's moving in contact with the ground. With a *search* versus *sneak* opposed roll, the subject can also determine the precise location of the target. Subject must activate sensor and remain motionless to use this ability. If the *medicine* roll to install fails by less than 5 points, subject suffers a constant -2 penalty to both *Strength* and *Dexterity* actions, and can't move beyond Cruising speed.

Source: Hero's Guide (page 131)

Neimoidian Data Goggles

Model: Stock Neimoidian Data Goggles

Type: Cybernetic interface

Scale: Character

Cost: 2,000 (includes implants and surgery)

Availability: 3; F or R

Game Notes: This is a cybernetic implant used by Neimoidians, and is not usually installed in non-Neimoidian patients (see below). To be of use, the goggles must be properly attuned to the wearer, and linked to a ship's computer and communications system. The goggles grant a 1D+2 bonus on all *astrogation*, *computer programming/repair*, and appropriate spacecraft *repair* rolls, as well as a 3D+1 bonus on all appropriate spacecraft *piloting* rolls. If a successful attack disrupt the vessel's internal communications network, the user must make a Heroic *Strength* check or be stunned for 1D+1 rounds. The price for such an installation is not only financial – the mere installation of the implant causes the pilot to lose +2 pips of both *Knowledge* and *Perception* (the loss is permanent). Neimoidian surgeons are unlikely to install this sort of

Cyborg Construct

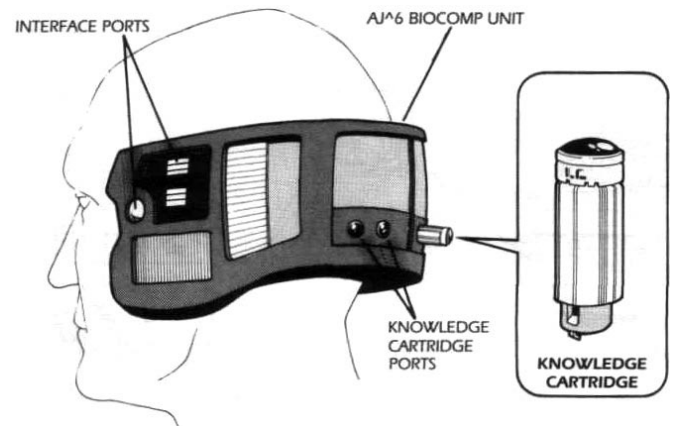

Model: BioTech Borg Construct AJ^6

Type: Basic cyborg construct

Cost: 80,000 for unit, 70,000 for surgery, 400 cheaper if without cyborg/droid interface

Cyber Points: 3

Game Notes: Increases *computer programming/repair* by 2D. Increases any *Knowledge* or *Technical* skill by 1D. Construct can store up to 8D worth of additional information. Cyborg can read the data in his data banks at any time.

Source: Cracken's Rebel Field Guide (page 31), Hero's Guide (page 130)

Weapon Mount

Type: Cybernetic weapon socket

Scale: Character

Skill: Medicine: cyborging (to install)

Cost: 50 (surgery: 2,500) (does not include weapon)

Availability: 2, R

Difficulty: To install: Easy

Game Notes: The character's arm end in a socket, on which any range of specially modified weapons can be mounted. Standard weapons cannot be mounted, custom cyber-weapons usually cost twice the normal cost of the weapon. If the *medicine* roll to install fails by less than 5 points, the weapon fails to operate consistently. Every time a weapon is fired (or every round, if the weapon uses a constant power flow, such as a lightsaber or vibroweapon), if the Wild Die rolls a 3 or less, the weapon fails to fire and shuts off (requiring an action to reactivate it).

Source: Hero's Guide (page 131)

Cybernetic Nexus Ring

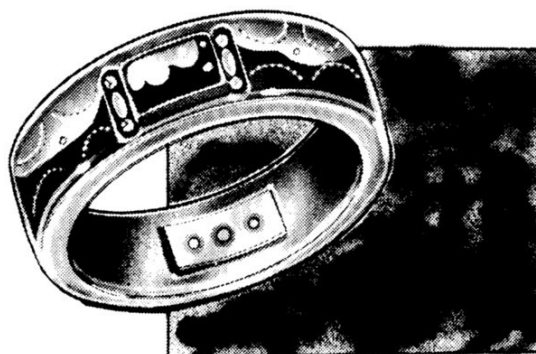

Model: Menendahl Cybertronic Nexus Ring

Type: Cyborg power interface

Cost: 5,000

Availability: 4, R

Game Notes: If the user stores one hour's worth of energy, the prosthetic in question gets a +1D *Strength* or *Dexterity* bonus for 10 minutes. No more than 15 minutes' worth of energy (use time; 1 1/2 hour charge time) can be stored by the ring. However, if a complication is rolled while the "charged" prosthetic is in use, the cyborg suffers 4D stun damage due to excessive energy feedback. If user employs the nexus ring more than once per week, have the user make a Moderate *willpower* roll for each additional use. If the roll fails, the cyborg has developed a psychological need for the boosted energy – if the user doesn't boost at least once a day, the character's *Strength* is considered reduced by -1D. While boosted, however, the character uses their full *Strength* and gets the +1D bonus for using the ring.

Source: Galladinium's Fantastic Technology (pages 34-35)

Survival

Glow Rod



Type: Standard glow rod
Cost: 10
Availability: 1
Range: 50 meters
Source: Rulebook (page 226), Heir to the Empire Sourcebook (page 107)

Luma Flare

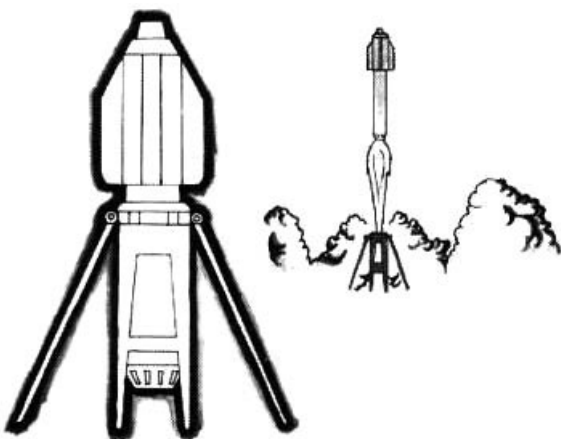

Model: Salamini Chemical Munitions Model-3287
Type: Aerial illumination system
Skill: Missile weapons
Cost: 100
Availability: 2
Range: 5 kilometers vertical, 10 kilometers horizontal
Blast Radius: 20 meters

Damage: 4D

Game Notes: Maximum range for the luma flare is five kilometers vertical and 10 kilometers horizontal. The illumination lasts for three minutes, and an area 300 meters in diameter is affected. While not designed as a weapon, luma flares will cause 4D burn damage to anyone within 20 meters of the detonation. Anyone within 50 meters of the detonation point and who is looking directly at the detonation point must make a Difficult *Perception* total or be blinded for eight minutes.

Source: Galaxy Guide 10: Bounty Hunters (page 91), Gundark's Fantastic Technology (pages 81-82), Rules of Engagement – The Rebel SpecForce Handbook (page 70)

Personal Strobe Locator

Model: Saladar Systems Solo Strobe

Type: Personal strobe locator

Cost: 100

Availability: 2

Game Notes: The comlink-sized strobe flashes every five seconds for up to 20 hours, and is visible for three kilometers.

Source: Platt's Smugglers Guide (page 54)

Anti-Insect Canister

Model: Barkesh Insect Culture

Type: Insecticide

Cost: 275

Availability: 3

Game Notes: A canister's contents can coat three full sized humans or protect the atmosphere within a small ship or within several meters of a small camp. The canister is effective up to one month from purchase, when the micro-organisms inside eventually die out.

Source: Gundark's Fantastic Technology (pages 79-80)

Animal Excluder

Model: Merr-Sonn Excluder

Type: Animal excluder

Scale: Character

Cost: 350

Availability: 2, F or R

Game Notes: The excluder has three power settings – low power (2D), normal power (4D), and high power (6D). Each setting forms a protective "sphere" with a diameter of 10

meters, 20 meters and 40 meters, respectively. Every round that a creature possessing senses in the affected range attempts to approach, it must make a *willpower* or *Strength* roll (whichever is higher) against the excluder's power setting to remain within the device's range. Failure means the creature retreats as far as it can until it is out of range; success means it can advance but suffers -2D to all actions due to irritation and distraction. Attempting to corner a creature, however, is not a wise move, as full flight-or-fight instincts remain in affected creatures.

Source: Gundark's Fantastic Technology (page 79)

Ration Concentrates

Model: Adventure Hiker & Hunter Ration Pack

Type: Compact field meal

Cost: 5

Availability: 1

Source: Rules of Engagement – The Rebel SpecForce Handbook (page 32), Arms and Equipment Guide (page 95)

Dehydrated Food Pack

Type: Standard dehydrated food pack

Cost: 2

Availability: 1

Game Notes: Each dehydrated food pack contains enough nourishment for a human for one meal (does not include liquids).

Source: Gundark's Fantastic Technology (pages 80-81), Tales of the Jedi Companion (page 122)

Water Purifier

Model: Pretormin Environmental WPR-60

Type: Water purification system

Skill: Survival

Cost: 100

Availability: 1

Game Notes: A Very Easy *survival* roll is required for normal use. The amount of time required to properly filtrate water samples is dependant on local sources. Average filtration time is 5 minutes. The unit will notify the user when cleansing process is completed.

Source: Galladinium's Fantastic Technology (page 67)

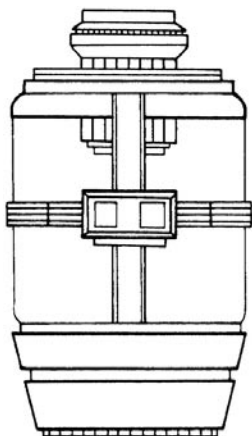

Water Purifying Canteen

Model: SurvivalGear Water JugFilter

Type: Water purifier

Cost: 100

Availability: 1

Game Notes: The water-purifying canteen can remove contamination from tainted water. It takes two minutes to purify *lightly contaminated* water, four minutes to purify *moderately contaminated* water, eight minutes to purify *highly contaminated* water, and 1D hours to purify *toxic* water. (See pages 20-21 for more information on water contamination).

Source: Rules of Engagement – The Rebel SpecForce Handbook (page 32), Arms and Equipment Guide (page 95)

Micro Fusion Reactor

Model: Lardanis Survival Systems MFCR-200 Power Generator

Type: Medium fusion power generator

Cost: 750

Availability: 1

Source: Galladinium's Fantastic Technology (page 55)

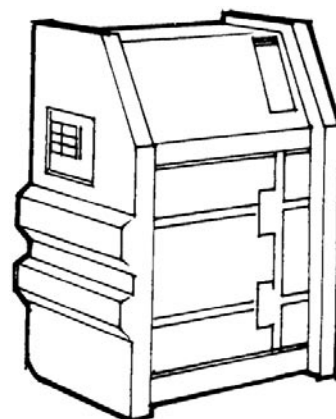

Energy Capacitor

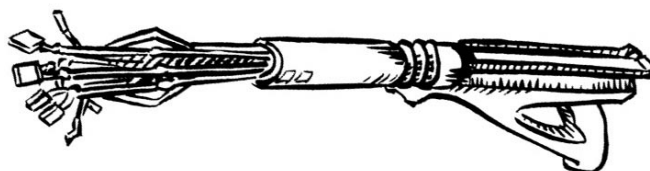

Model: Dardrennis Survival Technologies EMS-500

Type: Energy collection system

Skill: Survival

Cost: 1,500

Availability: 2

Game Notes: An Easy *Technical* roll is required for normal operation. The difficulty level may vary depending upon the type and amount of energy flow being accessed. Energy collection rates will vary from anywhere for an hour (from large power source or generator) up to six days (such as from low power blaster power packs) for a full charge.

Source: Galladinium's Fantastic Technology (page 65)

Defel Heat Reducer

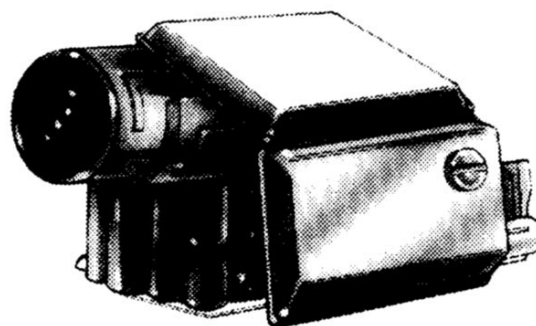

Model: Farendress Defek Exports HR-1200

Type: Heat reducer/energy generator

Cost: 500

Availability: 2

Game Notes: When operating in an environment with high levels of ultraviolet radiation, the exchanger can produce enough energy to power several datapads or other small appliances.

Source: Galladinium's Fantastic Technology (pages 29-30)

Heat Induction Staff

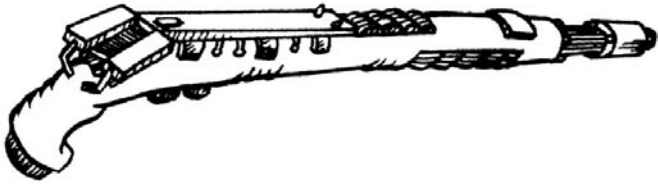

Model: Salasetti Survival Systems, Incorporated Heat Induction Staff

Type: Emergency heat generator

Skill: Survival

Cost: 300

Availability: 2

Game Notes: An Easy *survival* roll is required for normal operation. Accidental contact with the heating point results in 3D damage.

Source: Galladinium's Fantastic Technology (page 66)

Portable Heater

Type: Portable heating unit

Availability: 2

Game Notes: Provides enough heat to keep a person alive within an enclosed area of a maximum of 3 cubic meters in temperatures down to -75 degrees C for several days, perhaps a week or two with careful regulation.

Source: Galaxy Guide 8: Scouts (page 46)

Radiation Deflection Pin

Model: Raffkind Industrial Radiation Screener

Type: Personal ornamentation energy deflectors (various styles)

Cost: 250-500

Availability: 2

Game Notes: Miniature power cell must be replaced after 50 hours of continuous use. This item adds +1D to any *survival* rolls concerning low-level radiation. Bonus does not apply to high-energy radiation situations, but warning alarm will sound if radiation levels exceed specified amounts.

Source: Galladinium's Fantastic Technology (page 36)



Radiation Deflection Badge

Model: Refkind Industrials Radiation Screener

Type: Industrial radiation deflector

Cost: 300

Availability: 2

Game Notes: Power cell must be replaced after 50 hours of use, regardless of actual radiation levels (cells cost 10 credits). Adds +2D to *survival* rolls made due to radiation exposure. Badge changes color if its radiation deflection levels are exceeded. Use the same effects as water contamination (pages 20-21) to determine the severity of radiation contamination.

Source: Rules of Engagement – The Rebel SpecForce Handbook (page 33)

Coolth Backpack



Model: Mos Espa Coolth Backpack

Type: Cooling backpack

Scale: Character

Cost: 200

Availability: 4

Game Notes: The pack consists of a powered cooling unit and a sunshield fabric that can function as a cloak or blanket. Wearing the pack keeps a character comfortable in high temperatures, granting a +1D+1 bonus to resist great heat.

Source: Arms and Equipment Guide (page 95)

Survival Pack

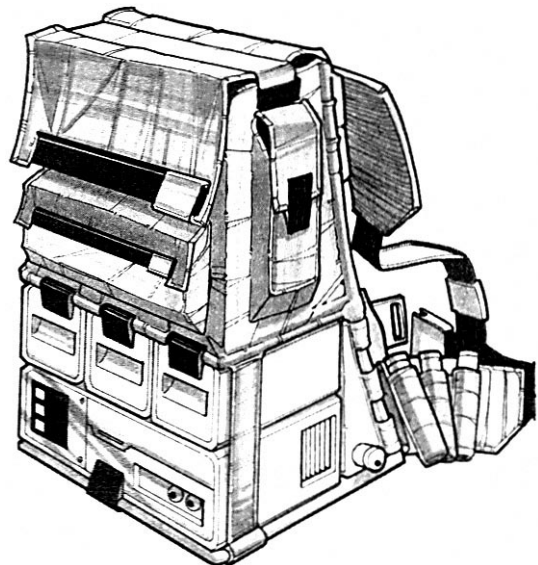

Model: Chedak Survival Kit

Type: Standard survival knapsack

Cost: 750

Availability: 2

Game Notes: Contains two week's rations, three medpacs, a glow rod, two thermal flares, a single-person di-chrome

shelter, a breath mask, six meters of syntherope, a knife, and a portable fusion power generator. Special missions-issue packs may include vibropick, fusion cutter, pocket computer, recording rod, portable field scanner, macrobinoculars, standard explosive charge, exposure suit, portable moisture vaporator.

Source: Platt's Smugglers Guide (page 54), Rebel Alliance Sourcebook (page 96), Rules of Engagement – The Rebel SpecForce Handbook (pages 38-39)

Scout's Survival Pack



Type: Custom survival pack

Cost: 900-2,000

Availability: 2

Game Notes: While each pack varies, they often consist of a backpack rig packed with any of the following items – breath mask, comlink, datapad, fusion grapple, glowrod, hold-out blaster (3D), macrobinoculars, medpac, personal moisture vaporator, rations, recording rod, survival shelter, syntherope, thermal flare. The pack may also contain other items added by individual scouts customizing their kits.

Source: Gundark's Fantastic Technology (pages 82-83)

Coruscant Survival Kit

Type: Typical Coruscant survival kit

Scale: Character

Cost: 250 (off-Coruscant), 500 (on Coruscant), value of credit stick not included

Availability: 1

Game Notes: Typical contents of the kit include: A credit stick containing a prepaid amount in Republic or Imperial currency (depending on era), maps of all major areas and sections of the planet (+2 bonus to all *planetary systems*: Coruscant skill rolls), breath mask and protective goggles for trips to polluted sectors, glow rod, "Stinger" hold-out blaster (3D, 3-4/8/12, 5 shots), datapad and comlink.

Source: Coruscant and the Core Worlds (page 123)

Jedi Utility Belt



Model: Standard Jedi Utility Belt

Type: Utility belt

Cost: 600

Availability: 3, R

Game Notes: Has several pouches containing a three-day supply of food capsules, a medpac, a tool kit, a spare power pack, a spare energy cell, a glow rod, a comlink, an Aquata Breather, and a couple of empty pouches for whatever else the wearer wants to add.

Source: Power of the Jedi Sourcebook (page 62), Ultimate Adversaries (page 156)

Breathing Gear

Oxygen Extractor

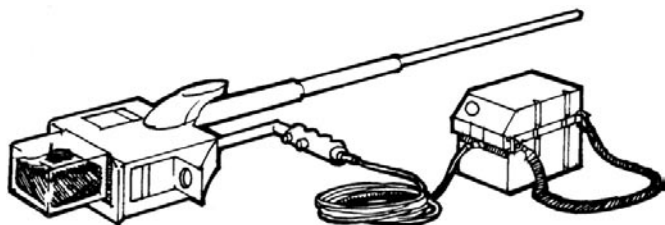

Model: Vercanne Mineral Technologies FOE-2000
Type: Oxygen extractor
Cost: 350
Availability: 2
Game Notes: Extracts oxygen from sub-surface water deposits or water vapor trapped in rock formations.
Source: Galladinium's Fantastic Technology (page 57)

Breather-1 Breath Mask

Model: Duwani Mechanical Products Breather-1
Type: Portable atmosphere-filtering system
Cost: 150
Availability: 2
Game Notes: Allows characters to survive in otherwise hostile gaseous environments. Note that the breath mask does not protect against gravitational or air pressures.
Source: Tales of the Jedi Companion (page 121)

Roamer-6 Breath Mask

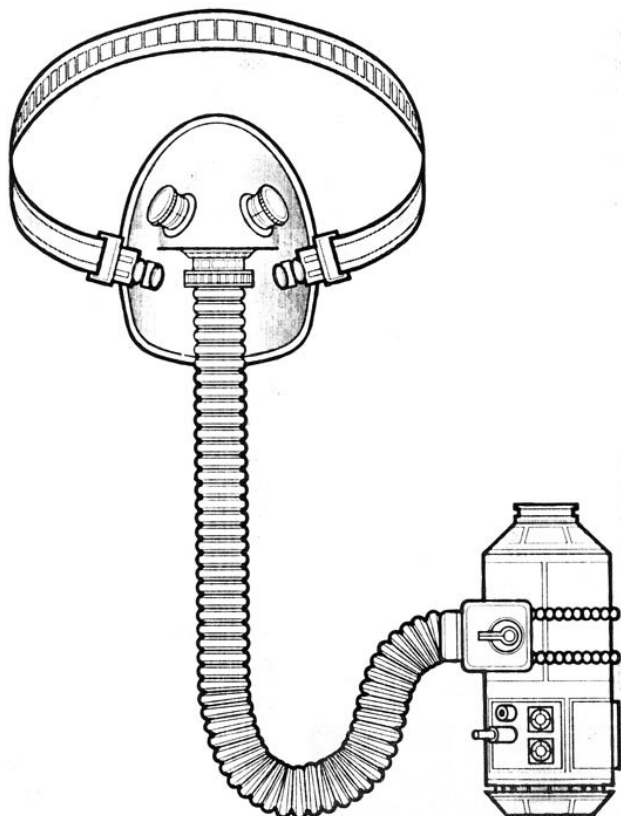

Model: Gandorthral Atmospherics Roamer-6 Breath Mask
Type: Breath mask
Cost: 400
Availability: 1
Game Notes: Provides six hours of breathable air on poisonous atmospheres. If there is not enough breathable gas in the atmosphere, the roamer uses its 10-minute compressed air supply. This item uses a special air cylinder (cost: 50) and air scrubbers (cost: 100) which must be replaced periodically.
Source: Arms and Equipment Guide (page 86)

Oxidizer

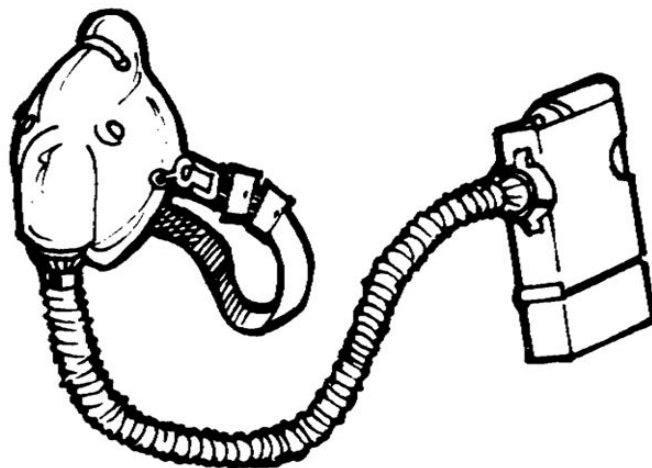

Model: Gandorthral Atmospherics Oxidizer
Type: Molecular oxygen extractor
Cost: 350
Availability: 2
Game Notes: Extracts breathable oxygen from poisonous atmospheres; lasts 4 hours on a full power pack. Power pack recharging takes one hour.
Source: Galladinium's Fantastic Technology (page 54), Rules of Engagement – The Rebel SpecForce Handbook (page 32), Arms and Equipment Guide (page 85-86)

Tasari Breath Mask



Model: Bavar Breathing Systems Portable Environmental Support Unit

Type: Breath mask

Cost: 40 credits

Availability: 3

Game Notes: Tasari breath masks cover the face and nose of humanoid beings. Oxygen is supplied through a hose, from a detachable tank. See the "Oxygen Tanks" entry for additional information.

Source: Adventure Journal 15 (page 187)

Tasari Oxygen Tank

Model: Tasari Elder Council Oxygen Tank

Type: Element of portable life support units, available in personal and vehicle models

Cost: 10 credits (personal) or 55 credits (vehicle)

Availability: 3

Game Notes: Allows work of about one standard hour before it must be refilled. Refilling generally costs about 1 credit for personal models and 5 credits for vehicle models. Tasari oxygen tanks have armor values of 1D (personal model) and 3D (vehicle model). Should a personal tank be punctured, the carrier is subjected to 2D damage from the explosion and shrapnel generated by the sudden release of compressed gases. When the vehicle tanks are punctured, all beings within 2 meters suffer 2D damage.

Source: Adventure Journal 15 (page 189)

Breath Mask

Model: VargeCorp
Easy Breathing
Breath Mask

Type: Breath mask

Cost: 50

Availability: 1

Game Notes: Provides one hours of breathable air.

Source: Rulebook (pages 225-226), Rules of Engagement – The Rebel SpecForce Handbook (page 32), Arms and Equipment Guide (page 86)



Emergency Life Support Module

Model: MineSystems Emergency Life Support Unit

Type: Emergency life support system

Cost: 3,000

Availability: 2

Game Notes: Unit provides enough oxygen to sustain 10 people for 30 hours (there are 10 masks). The module is a rectangular box, 2 meters by 1 meter by 1.5 meters. The unit will activate automatically if its sensors detect a dangerous drop in air quality. The module has emergency supplies, two medpacs, and an automated distress beacon.

Source: Flashpoint! Brak Sector (page 25)

Aquata Breather



Model: A99 Aquata Breather

Type: Breathing device

Scale: Character

Cost: 350

Availability: 2

Game Notes: Provides up to 2 hours of breathable air through its mouthpiece. The A99 has advanced filters to allow it to function underwater, in a vacuum, and in certain poisonous environments.

Source: d20 Core Rulebook (page 140), Arms and Equipment Guide (page 85)

Organic Gill

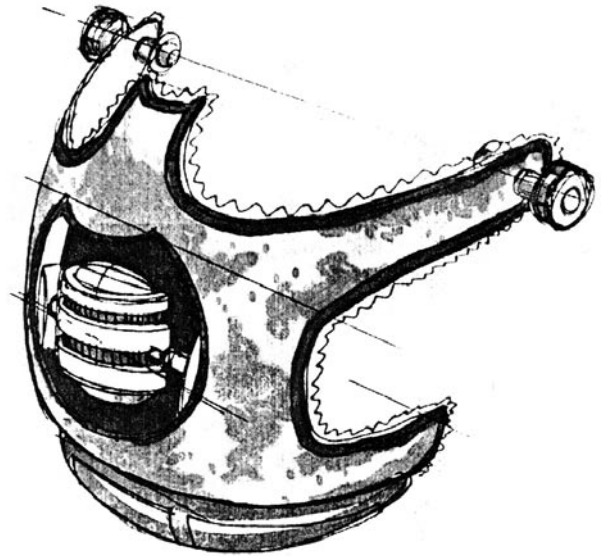

Model: Mon Calamari Organic Gill

Type: Synthetic organic gill

Cost: 200

Availability: 3

Game Notes: While wearing an organic gill, a diver may breathe in underwater environments.

Source: The Jedi Academy Sourcebook (page 140), Gundark's Fantastic Technology (page 76), Arms and Equipment Guide (page 86)

Gnullith

Model: Yuuzhan Vong Gnullith

Type: Organic breath mask

Scale: Character

Cost: Not available for sale

Availability: 4

Game Notes: A gnullith is an organic breath mask that sticks a proboscis down the user's throat, allowing him to breath any non-corrosive gas, or underwater. To successfully employ a Gnullith requires a Moderate *Strength* check, which can be attempted once per round.

Source: d20 Core Rulebook (page 356), The New Jedi Order Sourcebook (page 22)

Lungworm

Model: Yuuzhan Vong Lungworm

Type: Organic breathing device

Scale: Character

Cost: Not available for sale

Availability: 4, X

Game Notes: A lungworm is worn in conjunction with a vacuum ooglith, and provides the wearer with breathable air for up to 2 hours. Once this time period is up, the lungworm dies.

Source: The New Jedi Order Sourcebook (page 123)

Kel Dor Antiox Breath Mask

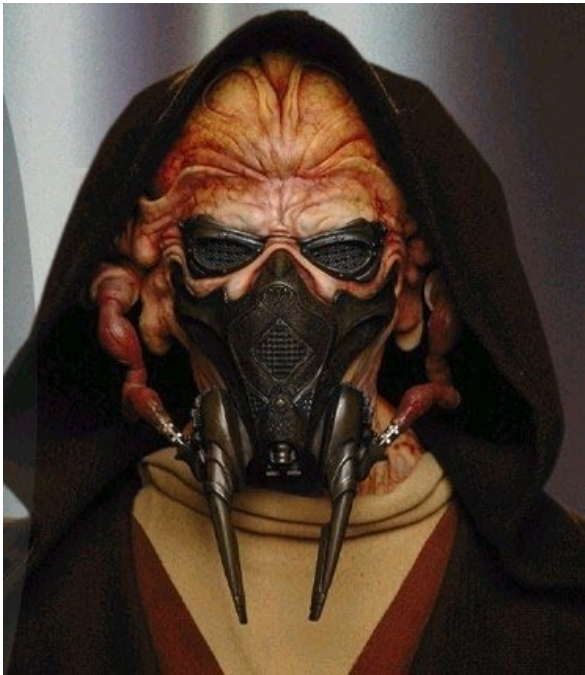

Model: Antiox Breath Mask

Type: Dorin isotopes breath mask

Cost: 2,000 (500 on Dorin)

Availability: 3

Game Notes: Any non-Kel Dor who attempts to breathe through the mask takes 4D damage. A One year supply of filters for an antiox breath mask costs 50 credits on Dorin and 200 credits elsewhere.

Source: Ultimate Alien Anthology (page 83)

Shelters

Shelter

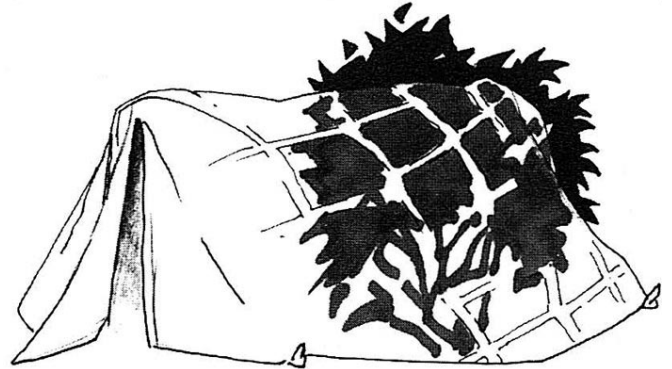

Model: Adventure Hiker & Hunter DuraShelter

Type: Single-person di-chrome multi-environment shelter

Crew: 1

Cost: 120

Availability: 2

Game Notes: Adds +2D to *hide* attempts once activated.

Source: Rules of Engagement - The Rebel SpecForce Handbook (page 39), Arms and Equipment Guide (page 95)

ThinHut



Model: Karflo Corporation ThinHut

Type: Insulation tent

Availability: 1

Game Notes: Provides up to 30 hours of limited protection against chemical exposure in most known atmosphere types. Small, 3 cubic meter shelter against cold and atmosphere. Can be folded into a packet no larger than a datapad, and considerably lighter.

Source: Galaxy Guide 8: Scouts (page 46)

Bubble Cloak



Model: Meredex Atmospheric EMS-90

Type: Emergency shelter

Cost: 800

Availability: 2

Game Notes: An Easy *Dexterity* roll is required for removal and inflation within 30 seconds. Puncture and heat resistant, opaque bubble has a *Strength* of 1D+2 to resist damage and atmosphere loss.

Source: Galladinium's Fantastic Technology (pages 42-43), Arms and Equipment Guide (page 95)

Emergency Inflation Shelter

Model: Valerenn Environmentals Personal Shelter Capsule

Type: Personal environmental protection shelter

Skill: Survival

Cost: 500

Availability: 2

Game Notes: Prior to activation, the PSC is a flat, 1 meter square, 25 centimeters thick cube that houses an inflatable, highly reflective fabric shelter. Filaments running throughout the fabric draw solar energy to the shelter's batteries, allowing for up to 10 hours of continuous use. When fully inflated, the shelter expands to a diameter of 2.5 meters and oxygen recycling and heating elements are automatically activated. A zippered entranceway gives access to the interior. A Very Easy *survival* roll is required for activation.

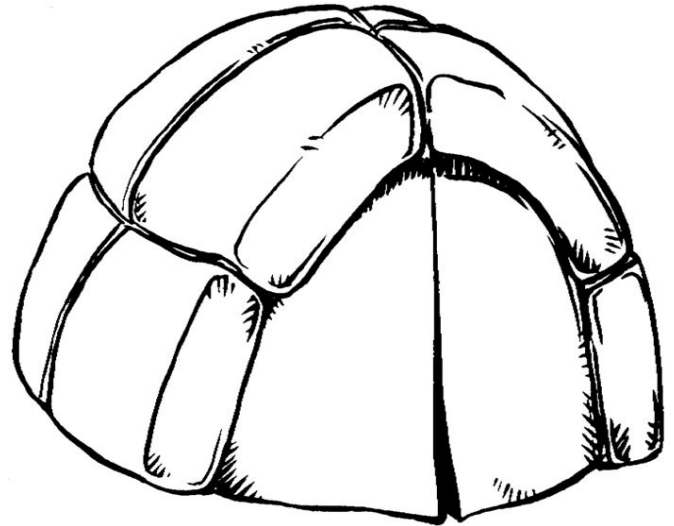

Source: Galladinium's Fantastic Technology (page 65)

Pressure Tent

Model: TasCorp Enviro-Tent 2A (small), 9B (medium), 30C (large)

Type: Survival tent

Skill: Survival

Cost: 100 (small), 350 (medium), 1,200 (large)

Availability: 3

Game Notes: A pressure tent provides a safe habitat on the surface of Tasariq. A small pressure tent uses 2 individual oxygen tanks, a medium pressure tent uses 2 vehicle oxygen tanks, a large pressure tent uses 4 vehicle oxygen tanks. The tanks provide one week of use. A pressure tent can be set up in about an hour. A small tent holds 1-3 people, a medium tent hold 6-12 people, a large tent hold 20-40 people. Pressure tents only protect the inhabitants from weather conditions, even severe storms. It provides no protection from blaster fire, explosions, or projectile or melee weapons.

Source: Adventure Journal 15 (page 190)

Aqua Survival Shelter

Model: Valerenn Environmentals Flotation Shelter

Type: Ocean survival raft

Cost: 2,500

Availability: 2

Game Notes: Equipped with a built-in homing beacon, heat vent, glow rod, six meters of syntherope, two medpacs, and a very large water tank. The generator has enough energy to last 250 hours. The supplies in the raft can support two people for two weeks. Reduce that time if more than two people are crammed inside.

Source: Platt's Smugglers Guide (page 54)

Communications

Communicators

Gnullith-Villip

Model: Yuuzhan Vong Gnullith-Villip
Type: Organic communicator/breathing device
Scale: Character
Cost: Not available for sale
Availability: 4, X
Game Notes: This is a gnullith/villip hybrid that allows a Yuuzhan Vong to communicate with anyone who is likewise equipped to a distance of 500 meters while allowing the user to breathe in an inhospitable environment.
Source: The New Jedi Order Sourcebook (page 123)

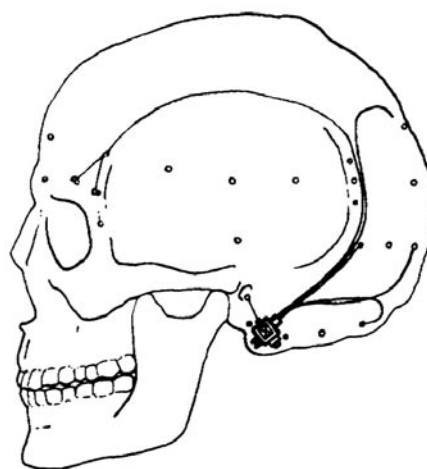

Husher Mike

Model: Crozo Industrial Products
 At-cyb Husher Mike
Type: Vocal communications implant
Cost: 3,000 (mike and receiver; implantation surgery is extra)
Availability: 3
Game Notes: Effective operating range is 1 kilometer. This device offers one way transmission of voice only and does not cover reception of voice or data transmissions.
Source: Galladinium's Fantastic Technology (page 61)

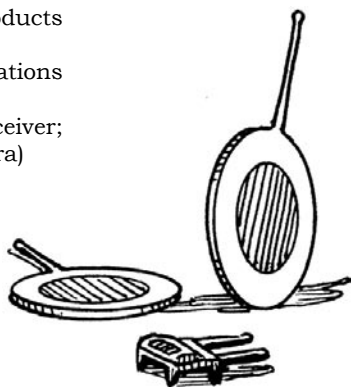

PTP Link

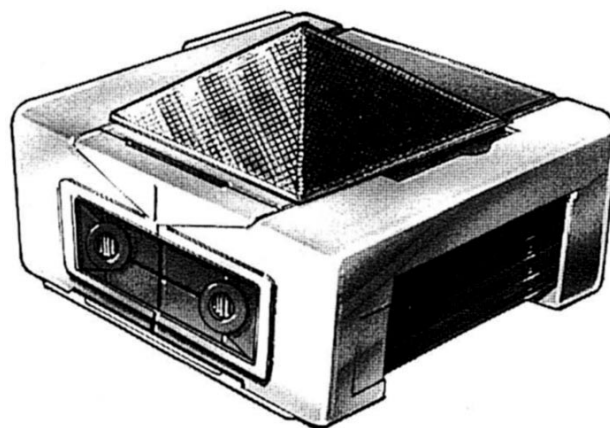

Implant Communicator

Model: Traxes BioElectronics Implant Communicator
Type: Implant personal communications unit
Cost: 12,500 (operation costs and license requirements will vary)
Availability: 4, F, R or X
Game Notes: Maximum broadcast range is 1 kilometer.
Source: Galladinium's Fantastic Technology (pages 87-88), Arms and Equipment Guide (page 88), Hero's Guide (page 131)

Type: Point-to-point multi-channel personal communicator
Cost: 150
Availability: 2
Game Notes: PTP links can reach distances up to 25 kilometers. Average PTP links are simple communication devices, capable of audio transmissions only. More expensive models often contain encryption packages that help secure a channel that is in use. Such PTP links can cost as much as 1,000 credits, and require a Moderate *communications* roll to use successfully. If successful, the channel is secured and cannot be deciphered.
Source: Gundark's Fantastic Technology (page 90), Tales of the Jedi Companion (page 123)

Personal Comlink



Type: General issue comlink
Skill: Communications
Cost: 25
Availability: 1
Range: 50 kilometers
Source: Rulebook (page 226), Heir to the Empire Sourcebook (pages 105-106)

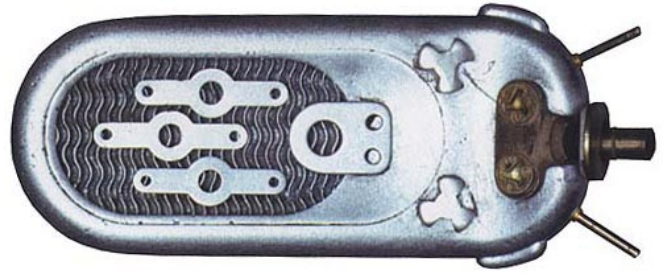

Availability: 4
Range: 100 kilometers over land and up to low orbit
Game Notes: Encryption technology requires a Heroic *communications* roll to decrypt if intercepted. The Hush-98 also creates a tiny field of white noise around the comlink and whoever holds it, making it difficult to overhear what is said into the unit (-2D *search* penalty to overhear) or sounds coming out of it (-3D *search* penalty).
Source: Arms and Equipment Guide (page 88)

C1 Personal Comlink



Model: SoroSuub C1
Type: Personal comlink
Skill: Communications
Cost: 200
Availability: 1
Range: 50 kilometers over land and up to low orbit
Source: Arms and Equipment Guide (page 87)

MultiNode Comlink

Model: BBC MultiNode Communications Link
Type: High-durability comlink
Skill: Communications: comlink
Cost: 75
Availability: 2
Difficulty: Moderate
Game Notes: 50 kilometer surface range, surface to orbit range in clear weather.
Source: Rules of Engagement – The Rebel SpecForce Handbook (page 37), Arms and Equipment Guide (page 86)

3-Mal Personal Comlink

Model: Crozo Industrial Products 3-Mal
Type: Personal comlink
Skill: Communications
Cost: 250
Availability: 1
Range: 50 kilometers over land and up to low orbit
Game Notes: Automatically monitors local “standard clear frequencies”, which are used for emergency news bulletins by military and civilian authorities.
Source: Arms and Equipment Guide (page 86)

Hush-98 Comlink

Model: SoroSuub Hush-98
Type: Personal comlink
Skill: Communications
Cost: 4,000

Wrist Chronometer

Model: MicroThrust
 Clockwatcher
Cost: 50 (+10 for thermo sensor; +10 for gravity sensor; +30 for atmosphere sensor; +50 for comlink; + 50 for droid linkup)
Availability: 1
Source: Galladinium’s Fantastic Technology (pages 46-47)



Headset Comlink

Model: Varge Copr. Hands-Free Comlink
Type: Headset comlink
Skill: Communication
Cost: 100
Availability: 1
Game Notes: Since the microphone transmitter is voice-activated, a headset comlink left on will broadcast any sound above background level.
Source: Platt’s Smugglers Guide (pages 47-48)

Military-Grade Comlink

Type: Military headset comlink
Skill: Communications
Cost: 900
Availability: 2, R
Range: 50 kilometers overland and up to low orbit
Game Notes: Can send encrypted messages that require a Heroic *communications* roll to decrypt if intercepted.
Source: Hero’s Guide (page 123)



Military Comlink

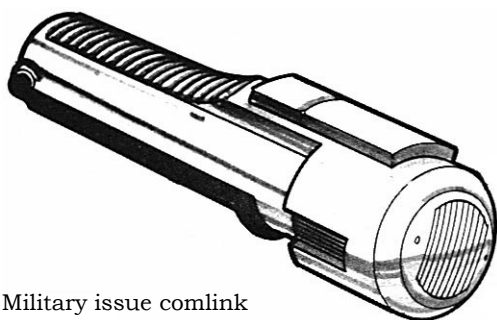

Type: Military issue comlink
Skill: Communications
Cost: 50
Availability: 2, R
Range: 50 kilometers
Source: Rulebook (page 226), Rebel Alliance Sourcebook (pages 95-96)

Secure-A3 Comlink

Model: Naboo Technologies Secure-A3
Type: Military comlink
Skill: Communications
Cost: 900
Availability: 1
Range: 50 kilometers over land and up to low orbit
Game Notes: Can send encrypted messages requiring a Heroic *communications* roll to decrypt if intercepted.
Source: Arms and Equipment Guide (page 87)



Comset

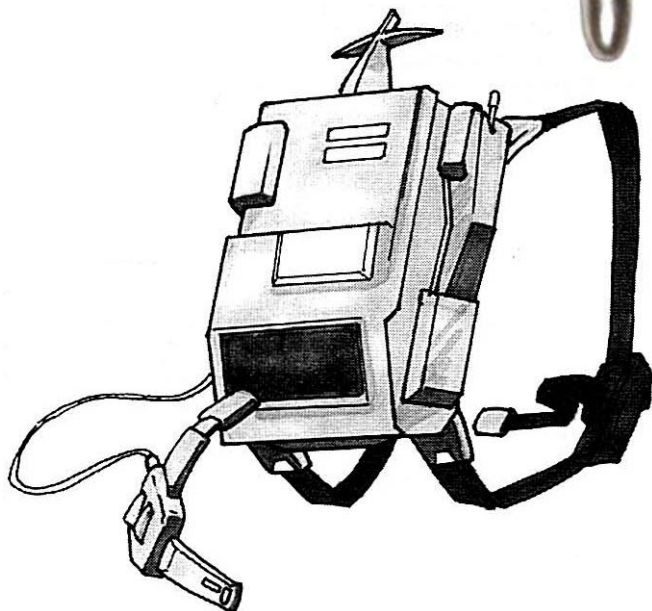

Model: BBC OmniNode Communications Set
Type: High-power multisignal comset
Skill: Communications: comset
Cost: 300
Availability: 2
Difficulty: Easy
Game Notes: 200-kilometer surface range, surface-to-orbit in harsh weather.

Source: Rules of Engagement – The Rebel SpecForce Handbook (page 37), Arms and Equipment Guide (page 86)

Vehicle Comlink

Type: Vehicle comlink
Skill: Communications
Cost: 300
Availability: 1
Range: 200 kilometers
Source: Rulebook (page 226)

Portable Message Transceiver

Model: Cirenian Communications Model SW-95
Type: Extended range message transceiver
Skill: Communications
Cost: 400
Availability: 2

Game Notes: Modulated broadcast relays extend broadcast and reception range to over 2,000 kilometers. Maximum range dependant on local conditions: inadequate communications outlets in outlying areas or extreme weather conditions can greatly hamper or eliminate communications capability.

Source: Galladinium's Fantastic Technology (page 67), Arms and Equipment Guide (page 86)

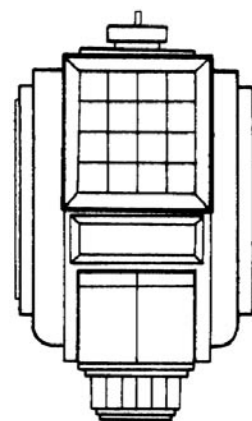

Visual Wrist Com

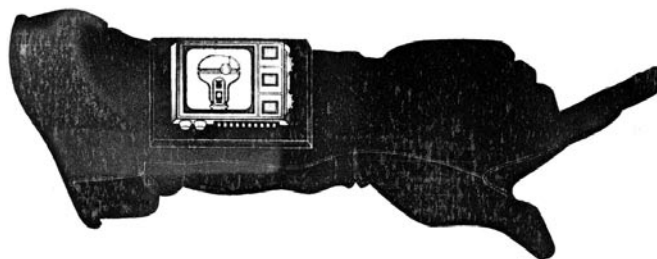

Model: Fabritech PAC20
Type: Visual wrist comlink
Skill: Communications
Cost: 1,500
Availability: 2
Range: 75 kilometers over land and up to low orbit
Game Notes: Can send and receive two-dimensional images as well as standard audio signals. Energy cell lasts 10 days of operation. Device also functions as a very basic datapad.
Source: Arms and Equipment Guide (page 87)

Holo Display Comlink

Model: Tramora Interstellar Communications VDV-100
Type: Holographic comlink
Skill: Communications
Cost: 800
Availability: 2
Game Notes: This comlink is able to receive and send holographic images, it can even receive (though not send)

HoloNet transmissions. A unique feature is the ability to match a recorded holographic image with the sender's live audio. When this feature is used, the sender's visual image is replaced by a recorded hologram (of him or another person), which moves to match the sender's speech. Detecting that the image does not exactly match the spoken message is a Difficult *search* task.

Source: Arms and Equipment Guide (page 88)

Holo Communicator



Model: Tramora Interstellar Communications VDV-100

Type: Holo communications display

Cost: 800

Availability: 2

Game Notes: Special security feature allow blockage of specific holo signals or identification of an incoming signal's source. A default built-in image processor can create a virtual image to replace the owner's actual features.

Source: Galladinium's Fantastic Technology (page 33)

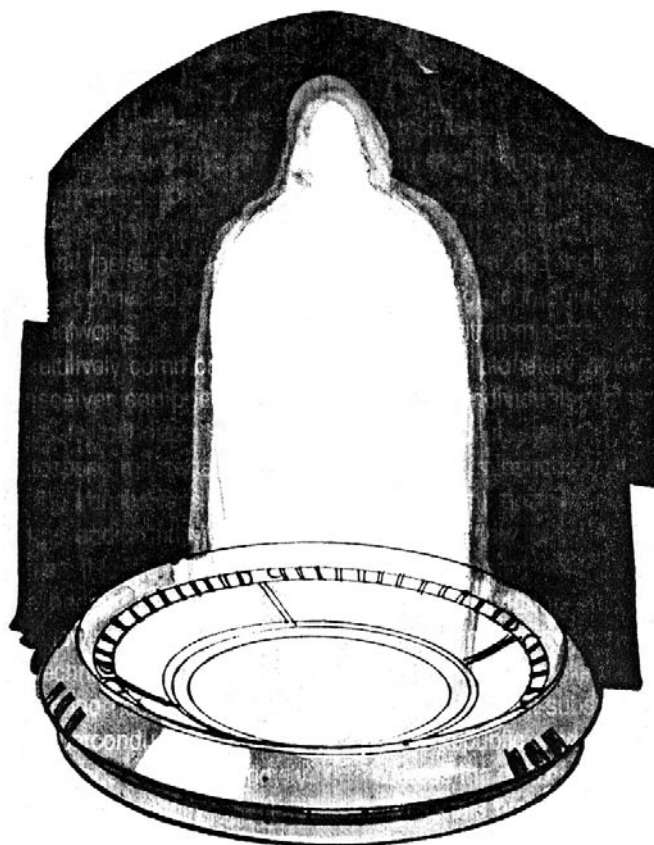

Cost: 250,000

Availability: 4, R

Game Notes: 2-meter-diameter disc allows for real-time audio, visual, and holographic communication over an unlimited range. It can also be used to search for specific information available on the HoloNet, just like a computer. However, since it was not designed for this function it imposes a -2D *computer programming/repair* penalty.

Source: Arms and Equipment Guide (pages 87-88)

Hologram Projection Pod

Model: SoroSuub Hologram Projection Pod

Type: HoloNet transceiver

Skill: Communications



Villip

Model: Yuuzhan Vong Villip

Type: Organic interstellar communicator

Cost: Not available for sale

Availability: 4

Game Notes: Created in pairs, these leathery lumps of flesh maintain contact with each other over even interstellar distances. Awakening a villip requires a Difficult *Knowledge* roll to stroke it correctly, after which it stimulates its twin to awaken as well. Each then unfolds along the sole break in its membranous tissue, and puckers its flesh into the shape of the owner of the villip at the other end. In effect, the villip shows its operator the features of the person he or she is communicating with, as well as emulating the voice and speech of its twin's owner.

Source: d20 Core Rulebook (page 356), The New Jedi Order Sourcebook (page 23)

Communication Disruptors

Alliance Communications Encrypter

Model: Alliance Communications Encoder/Decoder

Type: Communications device

Skill: Communications

Cost: Not for sale

Availability: 4

Game Notes: The encrypter adds +2D to the users *communications* skill for encoding or decoding transmissions. Carried Code Quasar has no game effect per se; it's more like flying an ID flag.

Source: Gundark's Fantastic Technology (page 96), Pirates & Privateers (page 47)

Pocket Scrambler

Model: Verge Corp. PS-xqt9s
Pocket Scrambler

Type: Data encryption device

Skill: Communications

Cost: 800

Availability: 4, F or R

Game Notes: An Easy *communications* roll is required for normal use. Without a similar device and the appropriate code, a Very Difficult to Heroic *communications* roll is necessary to decrypt message.

Source: Galladinium's Fantastic Technology (page 62), Arms and Equipment Guide (page 88)



Jammer Pack

Model: Modified M39
MicroThrust ComTech
Eavesdrop Protection Unit

Type: Communications
disruption unit

Skill: Communications

Cost: 1,050 (basic unit),
3,400 (Imperial modified
unit), 1,750 (jury-rigged
unit)

Availability: X*

Game Notes: To successfully activate the jammer pack requires a Moderate *communications* roll. If successful, it produces high-gain white noise on all communications bandwidths, preventing any comlink transmission within a 150-meter radius. A successful Difficult *communications* roll is necessary to tie the jammer pack into an integrated communications network (such as the comlink system in Imperial Palace on Coruscant). If completed, the jammer

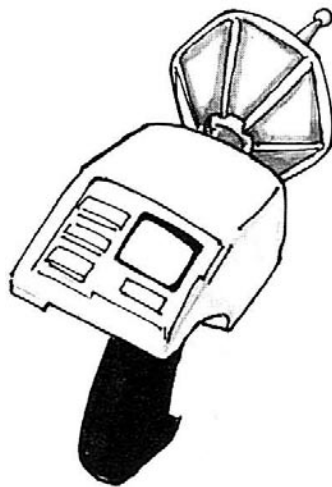

pack produces communications-fouling noise that is broadcast throughout the entire system, completely shutting down the network. The jammer pack can tie into an integrated network from any public access terminal, but this normally requires several additional *computer programming/repair* totals to successfully slice into the network's management program routines.

* **Note:** This item is not available prior to the Battle of Endor.

Source: The Last Command Sourcebook (pages 121-122), Gundark's Fantastic Technology (pages 89-90), Rules of Engagement – The Rebel SpecForce Handbook (pages 42-43), The Thrawn Trilogy Sourcebook (page 191), Arms and Equipment Guide (page 92)

Communication Aids

Anomid Vocalizer Mask



Model: Anomid Vocalizer Mask

Type: Alien vocabulator

Cost: 100

Availability: 3

Game Notes: The mask converts the subtle movement of the anomid's jaw and throat muscles into synthesized words and phrases. It's programmed for one language only (usually Basic) but can be reprogrammed to synthesize words in a different language, with a Heroic *computer programming/repair* roll. A non-anomid needs a Very Difficult *Dexterity* roll to operate the mask correctly.

Source: Ultimate Alien Anthology (page 11)

Qwohog Vocalizer Mask

Model: Qwohog Vocalizer Mask

Type: Alien vocabulator

Cost: 100

Availability: 3

Game Notes: The mask converts sound waves and subtle movement of the wearer's jaw into synthesized words and phrases, allowing Qwohog to converse on land. It's programmed for one language only (usually Basic or

Qwohog) but can be reprogrammed to synthesize words in a different language, with a Heroic *computer programming/repair* roll. A non-Qwohog needs a Very Difficult *Dexterity* roll to operate the mask correctly.

Source: Ultimate Alien Anthology (pages 126-127)

AlienEnhancer Voicebox

Model: Whappamanga AlienEnhancer Voicebox

Type: Audio playback unit

Cost: 75

Availability: 2 (Basic), 3 (other languages)

Game Notes: This is a simple audio playback unit with twelve preprogrammed basic phrases (“Yes”, “No”, “Greetings”, “When?”, “Where?”, “How much?”, “Please take me to someone with authority”, “I understand”, “I need medical attention”, “I mean no harm”, “I’m sorry”, and “I don’t speak Basic”, each with its own button. Useful for species unable to speak Basic.

Source: Arms and Equipment Guide (page 88)

Transliterator

Model: Consolidated Learning Systems Transliterator

Type: Language interpretation unit

Skill: Communications

Cost: 1,200 (includes 500 most common languages), 500 (module with 500 additional languages)

Availability: 3

Game Notes: An Easy *communications* roll is required to properly select up to 20 different languages to be tracked. Device is effective to a range of 10 meters, but aural receptors focus on nearest sounds first. Individual displays of phrase or word translations can either remain in place until manually cleared by user or clear after a pre-set delay period of 15 seconds. This unit’s database contains 500 specific “common” languages and dialects.

Source: Galladinium’s Fantastic Technology (page 47)

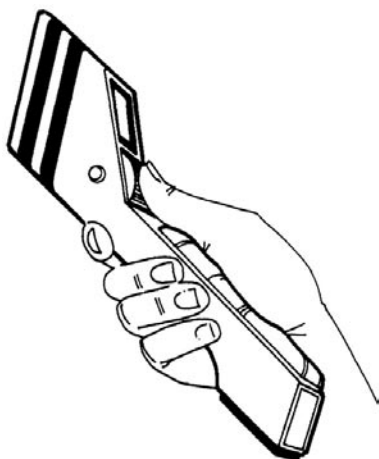

Tizowym

Model: Yuuzhan Vong Tizowym

Type: Organic translator

Scale: Character

Cost: Not available for sale

Availability: 4

Game Notes: A tizowym, which is placed inside a Yuuzhan Vong’s ear, allows him to speak and understand one specific language.

Source: d20 Core Rulebook (page 357), The New Jedi Order Sourcebook (page 23)

Beacons

Landing Beacon

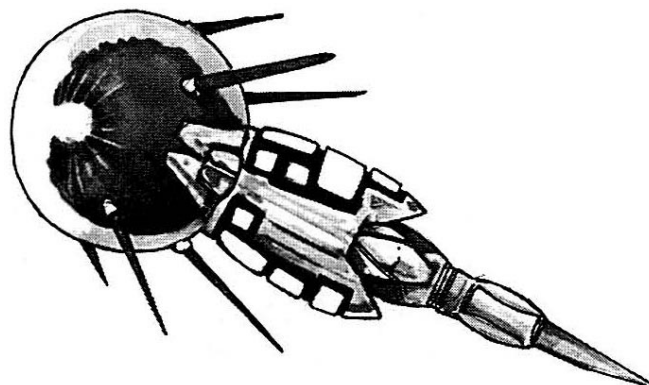

Model: Alliance Landing Beacon

Type: Multifrequency landing beacon

Cost: Not available for sale

Availability: 3

Game Notes: Uses *sensors* to detect, Moderate if frequency and mode is known, Very Difficult otherwise.

Source: Rules of Engagement – The Rebel SpecForce Handbook (pages 44-45)

Distress Beacon

Model: Saladar Systems PED-21 Distress Beacon

Type: Portable emergency distress beacon

Cost: 200

Availability: 2

Game Notes: Transmits personal transponder codes along all major subspace frequencies

at a range of up to five light-years. Normal operation is automatic upon activation. A moderate *communications* roll is required, however, should the user attempt to calibrate the device for non-standard bandwidths, such as Imperial military, government-restricted or Alliance frequencies.

Source: Galladinium’s Fantastic Technology (pages 64-65), Arms and Equipment Guide (page 95)

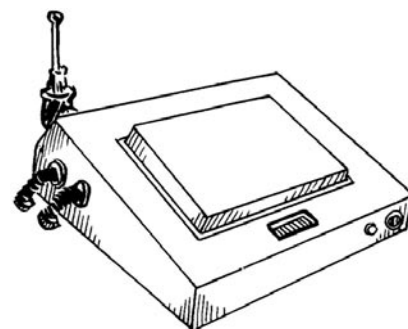

Portable Emergency Beacon

Model: Chedak Emergency Pack

Type: Personal emergency beacon

Cost: 1,000

Availability: 2

Game Notes: Burst beacon broadcasts your position on an emergency frequency, with a range of four light years. A strobe also marks your position. Also contains a detachable glow rod and a general recharge power jack. The mini generator has enough power for 250 hours, less one hour for each item it recharges.

Source: Platt’s Smugglers Guide (pages 53-54)

Information

Computers

Datapad



Model: Standard Datapad
Type: Portable computer workstation
Skill: Computer programming/repair
Cost: 25-100
Availability: 1
Source: Rulebook (page 226), Gundark's Fantastic Technology (pages 92-93), Heir to the Empire Sourcebook (pages 106-107)

MicroThrust Portable Computer

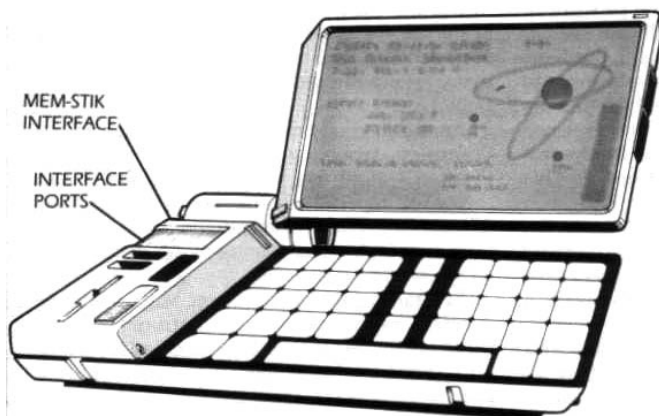

Model: MicroThrust Portable Computer
Type: Portable computer
Skill: Computer programming/repair
Cost: To calculate the price of a portable add the cost of the power to the cost of the memory.
Availability: F
Power: The power ratings range from 0D to 5D. A character using a portable adds the machine's power to his *computer programming/repair* roll. Power cannot be upgraded – a new computer has to be bought for more power.

0D Power	5,000 Credits
1D Power	10,000 Credits
2D Power	25,000 Credits
3D Power	35,000 Credits
4D Power	45,000 Credits
5D Power	55,000 Credits

Memory: A portable comes equipped with 5D of memory. Each additional 1D costs 500 Credits. Memory can be upgraded by paying the cost of the additional memory. Maximum memory is 20D.
Source: Cracken's Rebel Field Guide (page 10)

Handheld Computer

Model: Standard Handheld Computer
Type: Computer
Skill: Computer programming/repair
Cost: Varies (see below)
Availability: 1
Game Notes: Handheld computers can be used to access public information networks, or even to slice into the HoloNet or other secure networks. It can be loaded with as many as 5 datacards simultaneously. Handheld computers grant a *computer programming/repair* bonus to rolls relating to calculation, or involving information download. The bonus depends on the computer's power:

Bonus	Cost
+1D+1	1,500
+1D+2	3,000
+2D	6,000

Source: Hero's Guide (page 125)



Private Computer

Model: Standard Private Computer
Type: Computer
Skill: Computer programming/repair
Cost: Varies (see below)
Availability: 1

Game Notes: Private computers can be used to access public information networks, or even to slice into the HoloNet or other secure networks. It can be loaded with as many as 5 datacards simultaneously. Private computers grant a *computer programming/repair* bonus to rolls relating to calculation, or involving information download. The bonus depends on the computer's power:

Bonus	Cost
+1D+1	1,200
+1D+2	2,400
+2D	4,800

Source: Hero's Guide (page 125)

Mainframe

Model: Standard Mainframe
Type: Computer mainframe
Skill: Computer programming/repair
Cost: Varies (see below)
Availability: 1

Game Notes: Mainframes are data processing and information storage computers, capable of supporting multiple users simultaneously. Mainframe security varies by the kind of corporation it belongs to. Mainframes grant a *computer programming/repair* bonus to rolls involving information download. The bonus depends on the mainframe's power:

Bonus	Cost
+1D+1	8,500
+1D+2	17,000
+2D	34,000

Source: Hero's Guide (pages 124-125)

Duros Bio-Computer

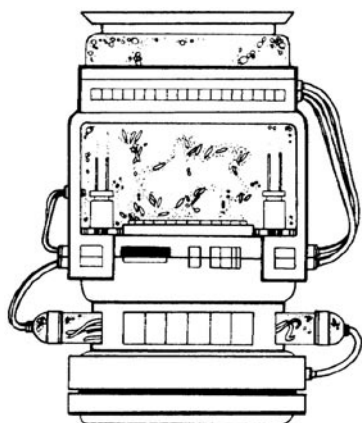

Model: MerenData Duros Bio-Comp 1000
Type: Biological personal computer
Skill: Computer programming/repair
Cost: 35,000
Availability: 4

Game Notes: Offers a maintenance-free performance standard with virtual independence from any external power source.

Source: Galladinium's Fantastic Technology (page 87)

Mon Calamari Aquatic Computer



Model: Kee-Piru environment ACCA-1dx000

Type: Aquatic computer

Skill: Computer programming/repair

Cost: 8,000

Availability: 4

Game Notes: Internal battery cell allows for continued use out of water up to 10 standard hours. As an advanced portable computer with powerful artificial intelligence modules, this computer adds +1D to the user's *computer programming/repair* rolls.

Source: Galladinium's Fantastic Technology (page 88)

TerexComm DataSearch 9C

Model: TerexComm-Deluxe (DataSearch Engine 9C)

Type: Administrative datasearch device

Skill: Computer programming/repair

Cost: 600

Availability: 2

Game Notes: An Easy *computer programming/repair* roll is required to connect the unit.

When connected, it adds 1D+2 to the character's *computer programming/repair* skill and 2D to the character's *security* skill when used to search for information. A Moderate *computer programming/repair* roll is needed to modify the

9C with the power condenser.

Source: Gundark's Fantastic Technology (page 93)

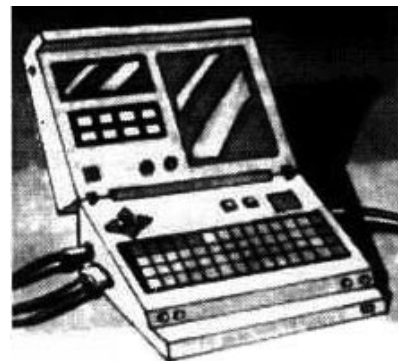

TerexComm DataSearch 12C-A

Model: terexComm Executive (DataSearch Engine 12C-A)

Type: Administrative datasearch device

Skill: Computer programming/repair

Cost: 850

Availability: 2

Game Notes: Using the 12C-A requires an Easy *computer programming/repair* roll. The 12C-A adds 2D to the character's *computer programming/repair* skill when searching for information.

Source: Gundark's Fantastic Technology (page 93)

CFC-100 Corporate Watcher



Model: CoreDataFiles CFC-100
Type: Corporate watcher computer
Skill: Business
Cost: 12,500, 10,000 credits annual service fee for weekly data upgrades
Availability: 2
Game Notes: Requires no specialized computer skills to install. However, an Easy *business* roll is required to retrieve information dealing with a given company's recent operations. Moderate or higher skill totals are required when attempting to model hypothetical "what-if" scenarios and analysis of long-term trends.

Source: Galladinium's Fantastic Technology (pages 28-29)

Galactic Currency Converter

Model: Bank of the Core GCC-1000

Type: Currency converter

Skill: Business

Cost: 300, 50 (additional sector modules)

Availability: 2

Game Notes: Base unit handles data for all major Core, Inner Rim and Colonies sectors. Additional program modules for additional sectors also available. An Easy *business* roll is required for normal operation.

Source: Galladinium's Fantastic Technology (page 66)

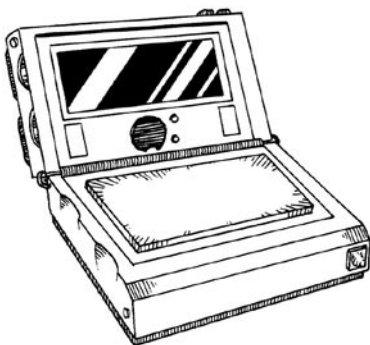

Pocket Secretary

Model: MicroData Pocket Secretary

Type: Audio activated datapad

Cost: 150

Availability: 1

Game Notes: Consists of a comlink-sized audio receptor device and an audio encoding datapad. Unit is activated with a predetermined codephrase, and proceeds to translate the



spoken information into computer data.

Source: Galladinium's Fantastic Technology (page 29), Arms and Equipment Guide (page 96)

Tag Scanner Datapad

Model: MerenData Data Scanner

Type: Tag scanner and datapad

Cost: 150

Availability: 2

Game Notes: The datapad can be modified to interpret other scan coding. This requires access to the coding cipher program, a Very Difficult *computer programming/repair* roll, and a Moderate *sensors* roll.

Source: Platt's Smugglers Guide (pages 50-51)

Permit Datapad

Model: BoSS Documentation Datapad

Type: Permit datapad

Cost: 150

Availability: 2, F

Game Notes: Altering data using the "read only" port as a "write only" port requires a Heroic *forgery* roll. Those using a custom-made input plug need to make a Difficult roll, but the forger must first purchase or make his own plug. Cracking the datapad to change documentation requires a Very Difficult *forgery* roll. Don't forget to factor in modifiers based on the *forgery* skill description on page 56 of the Rulebook. Failure at most of these rolls often lowers the forger's quality. Rolling a 1 on the wild die means the forger has accidentally fried the circuitry and destroyed the datapad.

Source: Platt's Smugglers Guide (pages 46-47)

Dodonna's Battle Analysis Computer

Model: Custom Battle Analysis Computer

Type: Battle analysis computer

Skill: Tactics: fleets, tactics: starfighters

Cost: Not available for sale

Availability: Unique

Game Notes: In addition to displaying course, distance, shield strength, firepower, damage, speed and condition of vessel for all combatants, the BAC has *tactics: fleets* 5D and *tactics: starfighters* 5D. A battlefield commander may defer to the machine's recommendations (use the BAC's skill for *tactics* rolls), or the BAC may assist the commander (use the rules for "Combined Actions" from the Rulebook).

Source: The Truce at Bakura Sourcebook (pages 136-137)

Personal Combat Threat Analyzer

Model: Golan Personal Combat Threat Analyzer

Type: Combat scanning device

Cost: 4,500

Availability: 4

Game Notes: this device provides a +1D bonus to *tactics* or *search* rolls pertaining to a specific combat situation. The gamemaster can use this device to give characters hints about a given combat situation without having to divulge all the facts pertaining to the situation: the results are given as a percentage probability of a certain attack's type, origin

and predicted future action.
Source: Galladinium's
 Fantastic Technology (pages
 88-89)

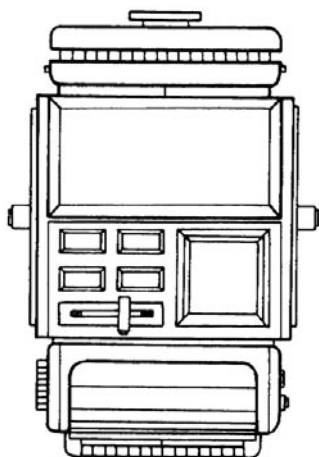

Spot-On Locator

Type: Urban navigational device
Cost: 50
Availability: 1
Game Notes: A user inputs an address directly onto the tiny device's display, which then links with orbital satellites to provide an interactive map showing the best route and the destination's district, megablock, block, subblock, level, and unit number.
Source: Coruscant and the Core Worlds (page 19)

Automap



Model: SoroSuub "Tracker" GPS Module
Type: Global positioning system
Scale: Character
Skill: Computer programming/repair
Cost: 2,000
Availability: 2
Game Notes: It is virtually impossible for a character using an Automap to get lost. As long as the device is linked to an orbiting source of data (such as a ship's sensors or weather satellite) the device relays accurate data regarding the user's location, local weather conditions, other moving obstructions and navigational hazards. The link requires a Moderate *computer programming/repair* roll once per hour to maintain. Failure indicates that the link has been terminated and the device will extrapolate the character's position with marginal accuracy. (Unlinked automaps produce faulty position data on anything less than a Difficult *computer programming/repair* roll.)
Source: Gundark's Fantastic Technology (page 80)

Navigation/Direction Finder

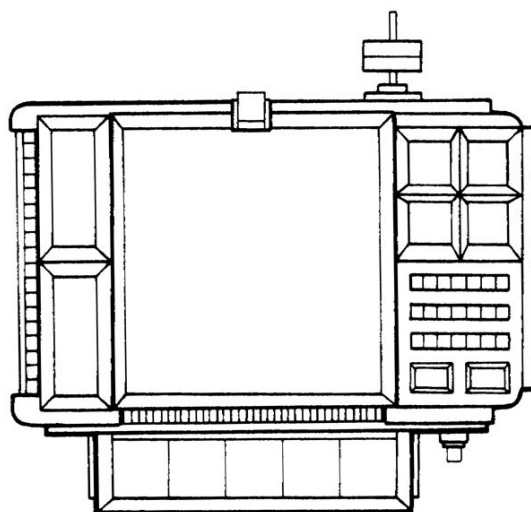

Model: Celextrian SNDF-12
Type: Satellite navigation/direction finder
Skill: Survival
Cost: 850
Availability: 2
Game Notes: An Easy *survival* roll is necessary for normal operation. In lieu of standard orbital satellite relay networks, coordinated broadcast signals may be received from local broadcast networks by adjusting reception band width (a Moderate *survival* roll).
Source: Galladinium's Fantastic Technology (page 67)

Directional Transponder

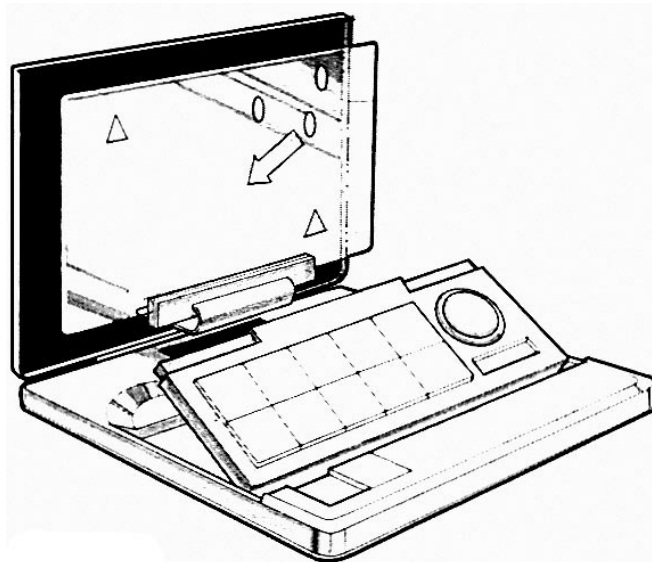

Model: Graph 18 Surface Locator
Type: Orientation console
Skill: Sensors: directional transponder
Crew: 1
Cost: 1,000
Availability: 2
Game Notes: Successful use adds +2D to *search: tracking* attempts to navigate unfamiliar terrain.
Source: Rules of Engagement - The Rebel SpecForce Handbook (page 38)

Accessories

Dedicated Terminal

Model: Standard Dedicated Terminal

Type: Computer device

Cost: 400

Availability: 1

Game Notes: A dedicated terminal is connected to a mainframe computer and has no processing power of its own. It can be loaded with as many as 5 datapads simultaneously, which it can read but not process or add data to them on its own, being little more than a monitor with a control interface.

Source: Hero's Guide (page 124)

Master Command Unit

Model: Authority master Command Unit

Type: master control unit

Cost: 100,000

Availability: 4, X

Game Notes: This small flat instrument can be used to remotely control over a total of 25 different technological items, mastering any signal within 300 meters. Code slicer takes over any nearby machinery, allowing the user to control it.

Source: Gundark's Fantastic Technology (page 93)

Universal Computer Interface

Model: MerenData Universal Computer Interface

Type: Computer access translator

Skill: Computer programming/repair

Cost: 2,500, 100 (annual software upgrades)

Availability: 1

Game Notes: A *computer programming/repair* roll is required for successful operation (difficulty varies based on how much the unknown computer system varies from standardized systems). A successful roll allows the user to add a +1D bonus to any subsequent *computer programming/repair* rolls using this system. This device will not override security programming in place nor will it permit otherwise unauthorized access to host systems. This unit does, however, provide for easy data transference between what might otherwise be incompatible system architectures.

Source: Galladinium's Fantastic Technology (page 32)

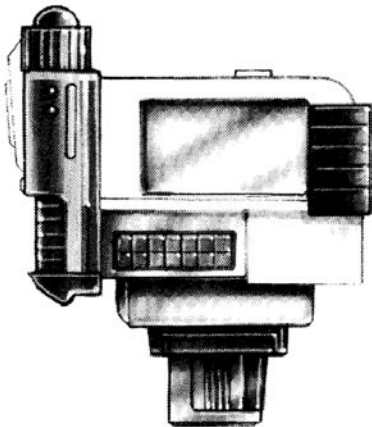

Datapad Remote Link Unit

Model: TaggeCo TC-40 Padlink

Type: Remote two-piece datapad/system interface unit

Cost: 1,000 credits

Availability: 2

Game Notes: Enables any authorized user to access and work from a conveniently sized datapad, while still keeping the user hooked into the primary system. The padlink has a range of 100 meters. An *Easy computer programming/repair* roll must be made to use the device in its intended fashion; a +5 modifier in addition to the assigned difficulty number is applied when characters determine their *computer programming/repair* roll when slicing into the target system. Installation of the comm unit onto a master terminal requires an *Easy computer programming/repair* roll.

Source: Adventure Journal 10 (page 142)

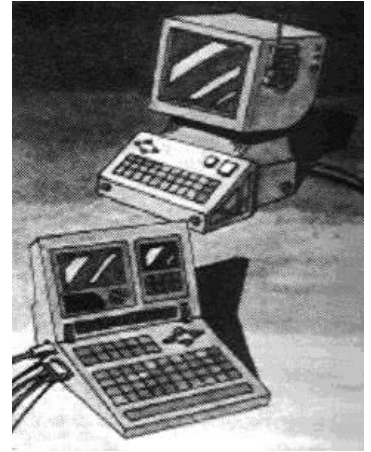

Cyborg/Computer Systems Data-Link

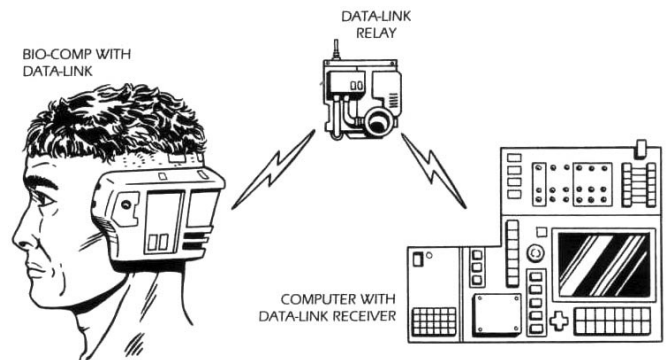

Model: Crozo Industrial Products At-Computer Link

Type: Allows long-range transfer of information between computer and cyborg

Cost: 500 (includes link with one computer), 100 for each additional computer

Range: 1,000 meters

Cyber Points: 1 (add 1 for each computer beyond the first)

Game Notes: Cyborgs can make *computer programming* rolls or give simple commands. At-Computer Link is linked to a *specific* computer, but extra computers may be added. Cyborgs can only manipulate simple operations on a ship, such as things that a computer normally handles by itself. Air locks can be opened, grappling hooks deployed or released. Piloting and gunnery are far too sophisticated operations to be run through the computer system.

Source: Cracken's Rebel Field Guide (page 32)

Synoptic Teacher

Model: Consolidated Learning Systems Synoptic Teacher

Type: Subconscious teaching system

Cost: 10,500, 200-1,000 (information modules)

Availability: 3

Game Notes: A variety of pre-designed information learning modules are available on a wide variety of subjects (gamemaster should determine availability). Transference



procedure takes between 15-30 minutes. Depending on the level of module content, its degree of technical or cultural sophistication, the user must make an Easy-Very Difficult *Perception* roll to effectively absorb the material. A successful roll means the user gains +1D-3D in that given skill or skill specialization if the character's skill level is below 5D (including attribute). The gamemaster is free to adjust costs, difficulties, skill bonus and maximum limits to any degree desired. The user may gain a benefit from a data module only once. The synoptic teacher is a favorite subconscious "brainwashing" tool of Imperial Intelligence and other organizations which may wish to plant post-hypnotic suggestions in the minds of operatives without their knowledge or consent.

Source: Galladinium's Fantastic Technology (page 47)

Remote Text Data Scanner

Model: Willienk Data Systems RTDS-1000

Type: Remote text data scanner

Skill: Communications

Cost: 750

Availability: 2

Game Notes: A Very Easy *communications* roll is required to properly scan hard copy datasheets; an Easy *communications* roll is required to transmit data.

Source: Galladinium's Fantastic Technology (page 45)

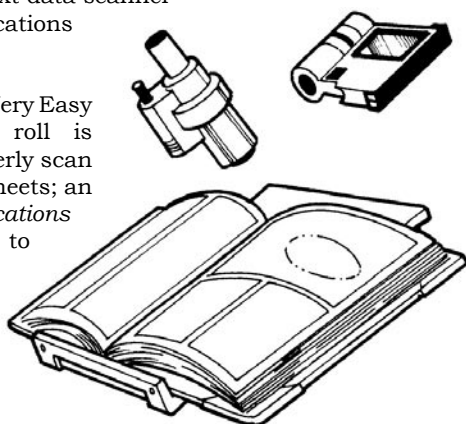

Crate Tag Imprinter

Model: MerenData Cargo Label Generator 2-CLG

Type: Crate tag imprinter

Cost: 1,500

Availability: 2, F

Source: Platt's Smugglers Guide (page 50)

Data Carriers

Electronic Identification Display

Model: MerenData IPI-1000

Type: Electronic identification/credential display

Skill: Security

Cost: 450

Availability: 2, possibly F

Game Notes: An Easy *security* roll is required to properly scan document images.

Holographically scans any document up to 30 centimeters long by 30 centimeters wide. Data storage is coded under one of 10 different security levels, personally coded.

Stores up to 12 documents. Only certified officials may perform document scans.

Source: Galladinium's Fantastic Technology (page 44)

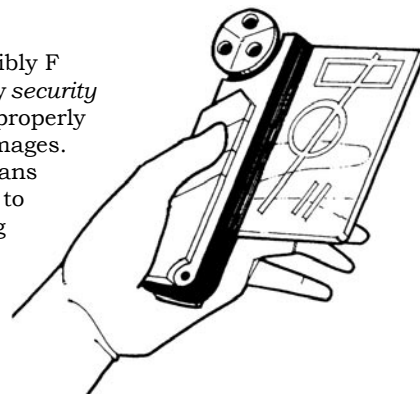

Mem-Stik

Model: Hi-Baka 2000 Mem-Stik

Type: Memory stick

Skill: Computer programming/repair

Cost: 50

Availability: 2

Game Notes: Each mem-stik contains 1D of data. The information can be broken down and reassembled into a larger file later on.

Source: Cracken's Rebel Field Guide (page 11)

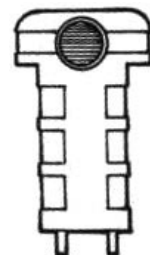

Cyborg Knowledge Cartridges

Model: Perzome SoftWEAR Cyborg Knowledge Cartridges

Type: Knowledge cartridges

Skill: Cartridges are available only for knowledge and technical skills.

Knowledge Skills

Basic	3D skill	250 credits
Expert	5D skill	750 credits
Master	6D skill	1,000 credits

Technical Skills

Basic	3D skill	500 credits
Expert	5D skill	1,500 credits
Master	6D skill	2,000 credits

Availability: R

Cyber Points: 0

Game Notes: Cyborg construct can hold a maximum of 6D worth of skills. Cartridges replace user's skill.

Source: Cracken's Rebel Field Guide (page 34)

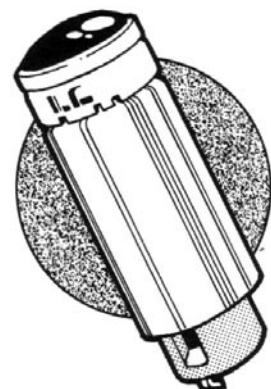

Vessel Courier System

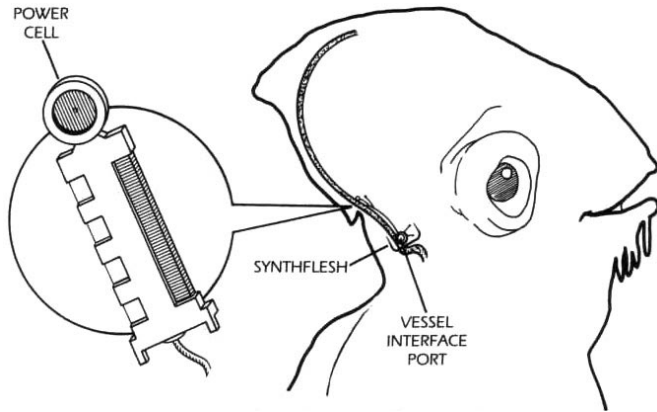

Model: Swift 78B Vessel Courier System

Type: Vessel Data Courier System

Cost: 5,000 for systems, 20,000 for operation

Cyber Points: 2

Game Notes: Vessel system can carry 8D of information. Vessel courier may not read the data or interact with it in any way. Virus protection package can be uploaded for 50 credits. After beating *computer programming* difficulty, takes one minute per die of information to upload. 8D may be downloaded in one minute.

Source: Cracken's Rebel Field Guide (page 30)



Source: Coruscant and the Core Worlds (page 66)

Code Cylinder

Model: Standard Code Cylinder

Type: Compact encoded security device

Scale: Character

Skill: Computer programming/repair

Cost: 500

Availability: 2

Game Notes: A code cylinder accesses computer data via a droid's comp link or provides entry into restricted facilities. Each cylinder features the user's personal security clearance data and access codes encrypted within them. Code cylinders can be programmed at properly equipped computers by making a Moderate *computer programming/repair* roll. Without such systems the difficulty is Very Difficult.

Source: d20 Core Rulebook (page 141)



Datadagger

Model: Datadagger

Type: Melee weapon/code cylinder

Scale: Character

Skill: Melee combat

Cost: 2,000

Availability: 3, R

Difficulty: Easy

Damage: STR+2 (maximum: 5D)

Game Notes: The code cylinder allows access to restricted data via scomp link, based on the owner's level of personal security clearance.

Jedi Holocron

Type: Jedi holocron

Cost: Not available for sale

Availability: 4

Game Notes: Using the information provided by a Jedi holocron will grant a +2 pip bonus to *repair* and *scholar* skill rolls that have to do with Jedi-oriented equipment (lightsabers, jedi armor, vehicles, starships, etc.).

If a character attempts to convince a "gatekeeper" (ie, the Jedi Master whose personality is imprinted into the holocron) to reveal information, he must roll a Very Difficult *scholar: Jedi lore* skill check. The character receives a +1 pip bonus for every Force point he has, and a -1 pip penalty for every Dark Side point he has. The gatekeeper is nothing more than a construct, and cannot be manipulated by the Force.

Source: Power of the Jedi Sourcebook (pages 62-63)

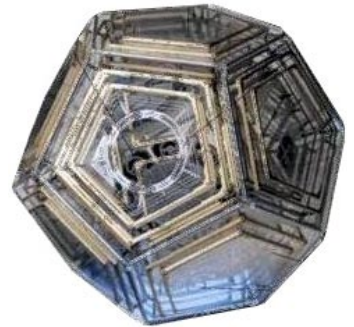

Sith Holocron



Type: Sith holocron
Cost: Not available for sale
Availability: 4, X
Game Notes: These devices act as interactive stores of information, most often used to retain the secrets of Force powers for future generations. The creator of the Holocron essentially transfers a portion of his personality into the object, and this sentient presence is then referred to as the gatekeeper of that Holocron. Using special organic crystalline components, the device can reproduce light and sound wave information. Each Holocron focus on different aspects of Sith lore and powers.
Source: Tales of the Jedi Companion (pages 79-80)

Sith Scroll

Type: Sith scroll
Cost: Not available for sale
Availability: 4
Game Notes: To read a Sith scroll requires that the reader be familiar with the Sith language, either through pre-established character knowledge, or a Very Difficult *languages* roll. A Sith library typically contains 16D scrolls. The chance that a character finds the information he is searching for is a cumulative 1% per scroll researched.
Source: Gamer Magazine



Marker Placard

Model: SoroSuub Marker Signs
Type: Starship signage
Cost: 10
Availability: 2
Source: Platt's Smugglers Guide (page 48)

Recorders & Projectors

Recording Rod

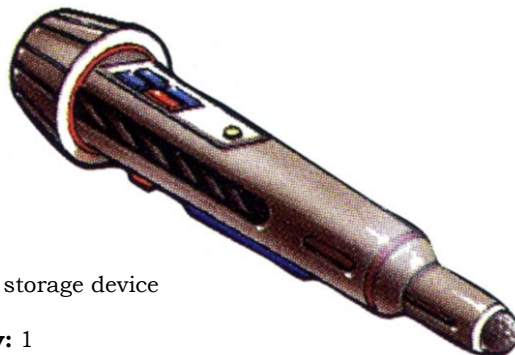

Type: Data storage device
Cost: 30
Availability: 1
Range: 15 meters
Game Notes: Can store up to 100 standard hours worth of audio-visual data.
Source: Rulebook (page 227)

Treaty Recording System

Model: Rebel Alliance Treaty Recording System
Type: Holorecorder
Skill: Holorecorder operation: Rebel Alliance Treaty Recording System
Cost: None
Availability: Only available to Rebel Alliance diplomatic teams
Game Notes: Recorder images are processed through a special set of RTZ security filters, then recorded on a WORM chip so the data cannot be modified. The main image lens on the RecSys holorecorder has a fixed focus and only one focal length (depth of visual field, 1.1 to 3 meters), making it unusable for long-range surveillance.
Source: Classic Adventures - Vol. 4 (page 5)

Biorecorder

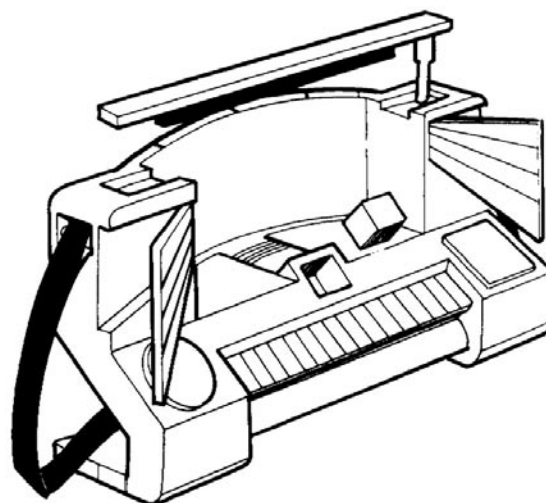

Model: Ulqib MicroTronics BX-333 BioRecorder
Type: Personal recording system
Cost: 5,000, 50 (holocubes)
Availability: 3

Game Notes: Matrix of sensors capture the feelings and emotions of the moment by recording the user's respiration, brain waves and bio-functions, as well as the words and holo-image.

Source: Galladinium's Fantastic Technology (page 42), Arms and Equipment Guide (page 88)

Chilab

Model: Yuuzhan Vong Chilab

Type: Organic covert recording media

Cost: Not available for sale

Availability: 4, X

Game Notes: Chilabs are "worn" in the nasal cavity of a subject. From this unlikely spot, they can "record" everything that their host sees and hears, creating a record that can be "uploaded" to a Qang qahsa (a biological memory storage device).

Source: The New Jedi Order Sourcebook (page 22)

Gorondin Holo Chronometer



Model: Gorondin Chronometrics Time Piece Model 7643

Type: Personal holographic chronometer

Cost: 300 (standard model), 50 (chips with additional imagery), 500+ deluxe models (depending upon features)

Availability: 2

Game Notes: Wearer can choose from over a dozen built-in holographic displays to relay time, temperature, or other vital information. Deluxe models allow personalized holo-messages up to 15 centimeters in height.

Source: Galladinium's Fantastic Technology (page 35)

Imagecaster



Model: SoroSuub Imagecaster

Type: Personal holoprojector

Cost: 1,000

Availability: 2

Game Notes: Can project holographic images up to 30 centimeters across and stores up to 100 minutes' worth of images. Can be connected to almost any data source, including droids, holorecorders and larger holoprojectors. It cannot transmit or receive images by itself, but if two comlink are each connected to an Imagecaster, they can send and receive real-time images. Energy cell lasts for 24 hours of use.

Source: Arms and Equipment Guide (page 88)

Hologram Projector

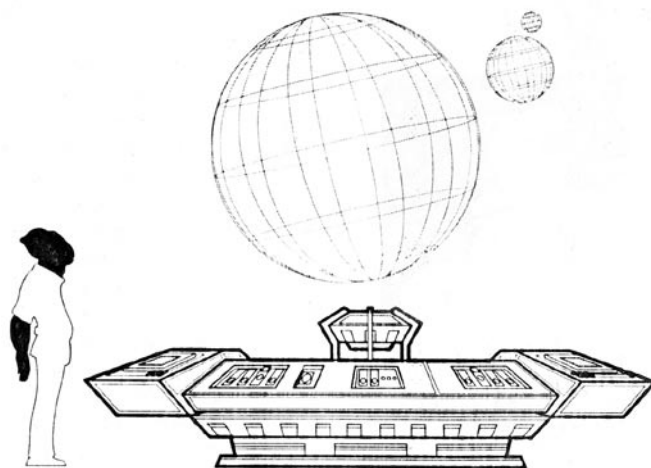

Model: Plescinia Entertainments CS-Mark 12

Type: Hologram projector

Cost: 10,000

Availability: 2

Game Notes: It is designed to receive holographic images from data slides, droids, comlink, subspace and hypertransceivers and even HoloNet transceivers. Can record and manipulate holographic images, as well as project a holographic image up to 5 meters in diameter.

Source: Arms and Equipment Guide (page 87)

Information Security

AccuTronics Encryption Package

Model: AccuTronics Encryption Package 1a.44.87

Type: Datafile encryption device

Skill: Computer programming/repair

Cost: 500

Availability: 2

Game Notes: Any datafile encrypted with the AccuTronics package gains a +5 modifier to its difficulty number to be found, and requires a Moderate *computer programming/repair* roll to crack the encrypt code if the password is known.

Source: Gundark's Fantastic Technology (page 96)

Analysis Encoding Computer

Model: Analysis/Encoding Docu-Server

Type: Analysis encoding computer

Skill: Computer programming/repair

Cost: Not for sale

Availability: 2, R (restricted to Imperial use)

Game Notes: A Moderate *computer programming/repair* roll enables a character to connect the a/e unit to another system. Once connected, a Moderate *computer programming/repair* roll activates the unit. Reduce the difficulty level of encryption on Imperial scandocs or files that have been transferred to the system with the a/e unit by one level (from Difficult to Moderate, etc.)

Source: Adventure Journal 10 (page 138)

DCD-4800 Cryptographer Coder

Model: Ealewon Electronics DCD-4800 Cryptographic Coder

Type: Computer data encryptor

Skill: Computer programming/repair

Cost: 1,200

Availability: 3

Game Notes: Requires and Easy *computer programming/repair* roll to secure selected data files with selected option(s) in place. Attempts to access encrypted files require a Difficult *computer programming/repair* roll if the user doesn't have the appropriate authorization.

Source: Galladinium's Fantastic Technology (page 29), Arms and Equipment Guide (page 94)

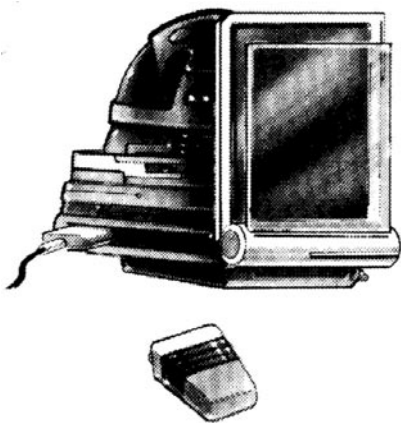

Data Bio-Encryptor

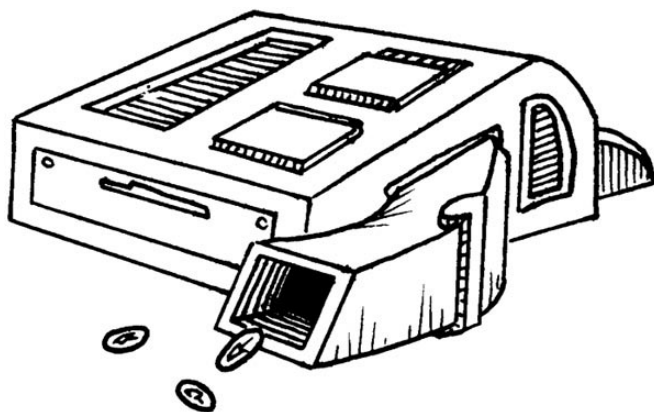

Model: Servenidain Securities, Limited Data Bio-Encoder

Type: Data transfer system

Skill: Computer programming/repair

Cost: 25,000

Availability: 3, R

Game Notes: An Easy *computer programming/repair* roll is required to successfully download and encrypt the desired information or to safely upload data upon arrival at one's destination. Ingested data capsule's time-release coating can be set for anywhere from 20 to 200 hours later. Detection of ingested data capsule requires a Heroic *sensors* roll.

Source: Galladinium's Fantastic Technology (page 60)

Credit Chip Bio-Encoder



Model: MerenData Credit Chip Bio-Encoder

Type: Biological encoder

Cost: 2,500

Availability: 3, R or X

Game Notes: An Easy *first aid* roll is required to properly encode a genetic sample from the owner. Attempts to access chip by unauthorized agents result in 4D stun damage.

Source: Galladinium's Fantastic Technology (page 43)

Slicing

Scomp Spiker

Model: Custom made
Type: Outlaw tech computer spiker
Cost: 20 (in spare parts)
Availability: X

Brief capsule: Spiker is plugged first into the scomp link, and then the power jack to prevent blowout. After charging, unit sends high voltage blast into computer system, melting connections and destroying programs along its course. This device is not selective, it is designed to destroy computer components, or at least the sub-station where it is used.

Source: Adventure Journal 13 (page 158)

Computer Spikes

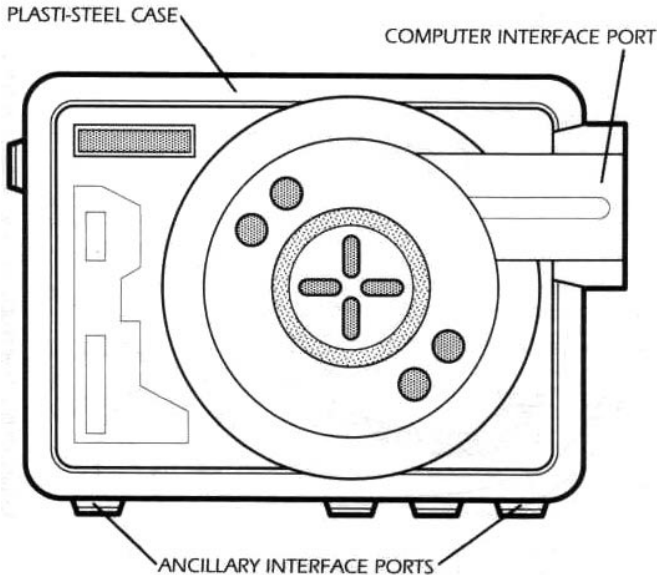

Model: MicroThrust Computer Spikes

Type: Computer spikes

Skill: Computer programming/repair

Availability: X

Name	Power	Cost
Piercer II	2D	3,000 Credits
Intruder	3D	4,500 Credits
Piercer IV	4D	6,000 Credits
Spear V	5D	7,500 Credits
Lancer	6D	9,000 Credits
Impalement		
Forward	7D	10,500 Credits
Riddle Eight	8D	12,000 Credits
Honey Comb IX	9D	13,500 Credits
Tunneler	10D	15,000 Credits

Game Notes: Character must make an Easy *computer programming/repair* roll to prepare the spike. If roll succeeds, the program can be slotted into the computer system to be raided. If the roll fails, the spike is ruined. The player then rolls the spike's die code against the difficulty number of the information. Use the *computer programming/repair* guidelines on page 63 of the Rulebook to determine the difficulty. A spike can only be used once.

Source: Cracken's Rebel Field Guide (page 8)

Unitech "Patch"

Model: UniTech Diagnostic Systems Diverter

Type: Interfacing system bridge

Skill: Computer programming/repair

Cost: 5,200

Availability: 2, R (restricted to governments)

Game Notes: The patch requires a Moderate *computer programming/repair* roll to apply, and adds 1D+2 to the character's *security* or relevant skill.

Source: Gundark's Fantastic Technology (page 94)

Surveillance

Binoculars

Dim Goggles

Model: Standard Dim Goggles

Cost: 50

Availability: 2

Game Notes: When worn by a light-sensitive character, these goggles negate any penalties caused by bright illumination or sunlight.

Source: Coruscant and the Core Worlds (page 123)



Macrolenses

Type: Macrolenses

Cost: 10,000

Availability: 2, F

Game Notes: These are worn like contact lenses, and can alter the appearance of a person's eyes (in Amaiza's case, they make her eyes appear to be slitted like a cat's). In addition to the cosmetic use, the macrolenses also add +2D to the wearer's vision-related *search* rolls, and they reduce all range penalties by one grade (ie, Long Range becomes Medium Range, Medium Range becomes Short Range, etc.).

Source: Gamer Magazine

Availability: 1

Range: 100-250/500/1,000

Game Notes: All modes have an Easy *sensors* difficulty at short range, increasing one level per range band. *Search* and other *Perception*-based rolls may be increased when using macrobinoculars by +3D when used to find something more than 100 meters away, at the gamemaster's discretion.

Source: Rules of Engagement - The Rebel SpecForce Handbook (page 40)

Wide-Scan Binocs

Model: Jassim Design VX3 Scanner

Type: Wide view binoculars

Cost: 100

Availability: 1

Game Notes: Wide-scan binocs provide a +1D bonus to *search* skill rolls where the target individual or area lies more than 20 meters away from viewer.

Source: Gundark's Fantastic Technology (page 90), Tales of the Jedi Companion (pages 123-124)

Ziko 1000 Macrobinoculars

Model: Ziko 1000 Field Macrobinoculars

Type: Image-magnification sensor

Skill: Sensors

Cost: 100

Macrobinoculars

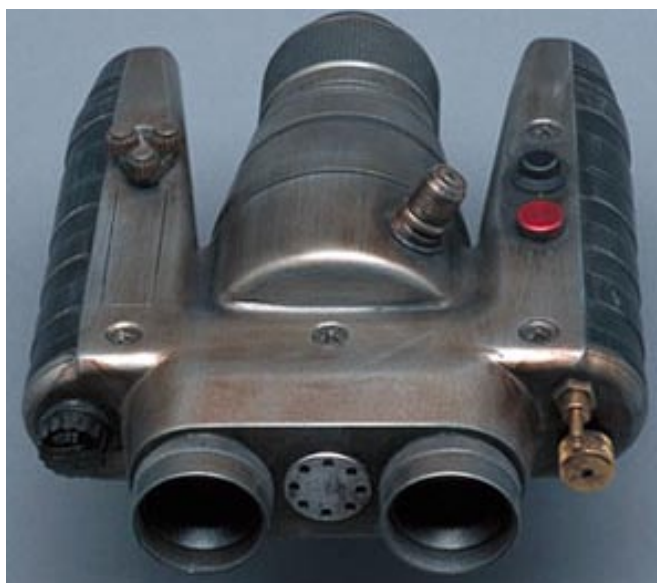



Type: Standard macrobinoculars

Skill: Sensors

Cost: 100

Availability: 1

Range: 100 meters to 1 kilometer

Game Notes: All *search* and *Perception*-oriented skills are increased by 3D when using the macrobinocular to view areas more than 100 meters away. If attached to a blaster via specialized programming software, they provide a +3D bonus to all medium and long-range shots, provided the attacker is in a steady "sniper" position.

Source: Rulebook (page 226), Heir to the Empire Sourcebook (page 109)

Headstrap Macrobinoculars

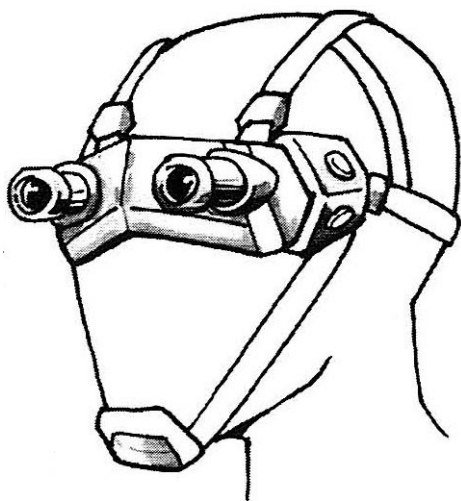

Model: Ziko 1125 Heads-Up Macrobinoculars

Type: head-mounted image-magnification sensor

Skill: Sensors

Cost: 200

Availability: 2

Range: 100-250/500/1,000

Game Notes: All modes have an Easy *sensors* difficulty at short range, increasing one level per range band. May be used to improve aiming by +2D with blaster or slugthrower weapons (at medium and long range) if the weapon is equipped with a laser-sight. *Search* and other *Perception*-based rolls may be increased when using macrobinoculars by +3D when used to find something more than 100 meters away, at the gamemaster's discretion.

Source: Rules of Engagement – The Rebel SpecForce Handbook (page 40), Arms and Equipment Guide (page 91)

Holorecording Macrobinoculars

Model: Neuro-Saav Model TT4 Holorecording Macrobinoculars

Type: Specialized image magnification/recording device

Skill: Search

Cost: 2,000

Availability: 2*

Game Notes: Holorecording macrobinoculars provide the normal advantages of standard image magnification devices (this specific unit gives +2D to all *search* or *Perception* rolls more than 100 meters away). In addition, the device can record up to three standard hours of visuals on a standard data card.

* **Note:** This item is not available prior to the Battle of Endor.

Source: The Last Command Sourcebook (page 123), Gundark's Fantastic Technology (page 88), The Thrawn Trilogy Sourcebook (page 189), Arms and Equipment Guide (page 90)

Experimental Holorecording Macrobinoculars

Model: SpecForce Holorecording Macrobinoculars

Type: Specialized image-magnification/recording device

Skill: Sensors

Cost: 8,000

Availability: 2

Range: 100-250/500/1,000

Game Notes: All modes have an Easy *sensors* difficulty at short range, increasing one level per range band. *Search* and other *Perception*-based rolls may be increased when using macrobinoculars by +3D when used to find something more than 100 meters away, at the gamemaster's discretion.

Source: Rules of Engagement – The Rebel SpecForce Handbook (page 41)

Infra-Goggles

Model: Drolan Plasteel Infra-goggles

Type: Infrared goggles

Cost: 300

Availability: 2

Game Notes: Reduces darkness-related attack difficulty modifiers by 2D. However, if intense light (from a glowrod or other sudden source of illumination) is shined directly on the goggles, the wearer must immediately make a Difficult *willpower* roll or be blinded for 1D rounds.

Source: Gundark's Fantastic Technology (page 89), Tales of the Jedi Companion (page 122)



Snooper Goggles

Type: Night macrobinoculars

Skill: Search

Cost: 300

Availability: 2, R

Game Notes: Adds +2D to *search* in low light conditions; goggles without photo-reducing sensors are susceptible to sudden flashes of light (the wearer can be blinded).

Source: Gundark's Fantastic Technology (page 90), Han Solo and the Corporate Sector Sourcebook (page 121)

Peer Snooper Goggles

Model: VidGraph Peer Macrobinoculars

Type: Low-light image-magnification sensor

Skill: Sensors

Cost: 300

Availability: 2, X in some systems

Game Notes: Add +2D to *search* in low light. All modes have an Easy *sensors* difficulty at short range, increasing one level per range band. *Search* and other *Perception*-based rolls may be increased when using macrobinoculars by +3D when used to find something more than 50 meters away, at the gamemaster's discretion.

Source: Rules of Engagement – The Rebel SpecForce Handbook (page 41), Arms and Equipment Guide (page 91), Ultimate Adversaries (page 156)

Das'skar Hunting Mask

Model: Nikto Das'skar Hunting Mask

Type: Hunting mask

Scale: Character

Cost: 3,000 (1,500 for a half-mask)

Availability: 4

Game Notes: This is a two-part mask: An upper half that covers the eyes, nose, and temples, incorporates special light-enhancing lenses that gives the wearer low-light vision (+1D in low-light conditions); and a lower half that covers the wearer's jaw and cheekbones, and includes sensors that enhance the wearer's ability to locate creatures by scent (+2 to *search: tracking* by scent).

Source: Ultimate Alien Anthology (page 110)

Kavaavik

Model: Yuuzhan Vong Kavaavik

Type: Organic night vision device

Cost: Not available for sale

Availability: 4, X

Game Notes: Kavaavik are flightless birds used by the Yuuzhan Vong so that they can see in the dark. When worn, the creature inserts its "spinal needle" into the user's optic nerve, allowing the user to effectively see in complete darkness at a range of up to 500 meters via echolocation. While wearing a kavaavik, the wearer is only able to perceive his surroundings as silhouettes, and cannot view datascreens, scrolls, etc. If the kavaavik is killed while being worn, its host is blinded for 1D rounds while his optic nerve adjusts.

Source: Gamer Magazine

Sensors

Hover-Cam

Model: Data-Link Industries 250 Hover-Cam

Type: Audio, visual and holo recording device

Cost: 900

Availability: 2, F

Game Notes: Using small repulsors, hover cams float about a meter above and slightly behind their user. They follow spoken directions to record information on a standard datacard.

Source: Gundark's Fantastic Technology (pages 88-89)

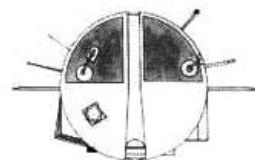
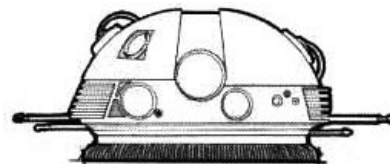

Eye In The Sky

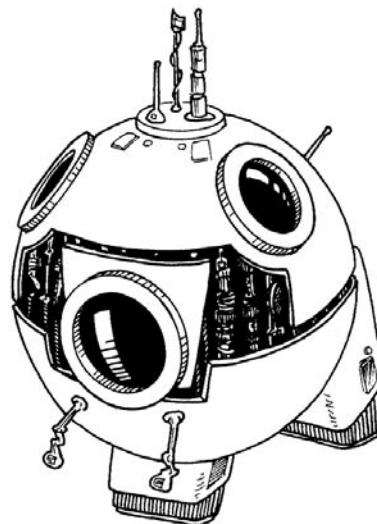

Model: Kystallio Detection Plus RMD-20 Eye In The Sky

Type: Remote monitoring device

Skill: Sensors

Altitude Range: Ground level-200 meters

Cost: 800

Availability: 2

Move: 45; 130 kmh

Game Notes: An Easy *sensors* roll required for initial activation only. Free flight operation is automatic. The device appears as a 30-centimeters diameter sphere studded with sensory apparatus and micro-repulsorlift nodes. Maximum hover height is 200 meters, maximum range is 10 kilometers, and maximum flight before cell recharge is 5 hours. Contains audio and visual sensors feeds to the user operate out to 100 meters radius.

Source: Galladinium's Fantastic Technology (page 60)

General Purpose Scanner

Model: Cryoncorp EnhanceScan
Type: Portable scanning device
Skill: Sensors
Cost: 2,000
Availability: 2
Game Notes: Able to scan to a range of 1,500 meters (though more than 1 meter of rock or metal blocks it). It can detect movement, find life forms and monitor comlink signals. Scanning for life forms or comm. signals requires a Difficult *sensors* roll. Device gives a +1D bonus to *search* rolls.
Source: Arms and Equipments Guide (page 89)



Sensor Beacon

Model: Fabritech SE-Vigilant Automated Sensor Beacon
Type: Sensor beacon
Skill: Sensors
Cost: 3,000
Availability: 2
Game Notes: It is a pole 1.4 meters long when collapsed and 3 meters long at full extension. Sensor has a built-in comlink with a 50-km range. When activated, it continually scans the area within 250 meters of it with a *search* skill of 5D to notice any vehicles or creatures moving within its monitored area. It can be set to sound an alarm or send an alert by comlink, when it detects a vehicle or creature of a particular size, or anything at all. Can also be continuously monitored locally or remotely via a video-comlink, granting a +1D *search* bonus.
Source: Arms and Equipment Guide (page 89)



Sensor Pack 9320/B

Model: NeuroSaav 9320/B Sensor Pack
Type: Portable scanning device
Skill: Sensors
Cost: 1,200
Availability: 2, R
Range: 50/150/300
Game Notes: Detects life forms, presence of comm signals, movement, density, mass, volume, and energy type and intensity. No *sensors* bonus.
Source: Rules of Engagement – The Rebel SpecForce Handbook (page 42)

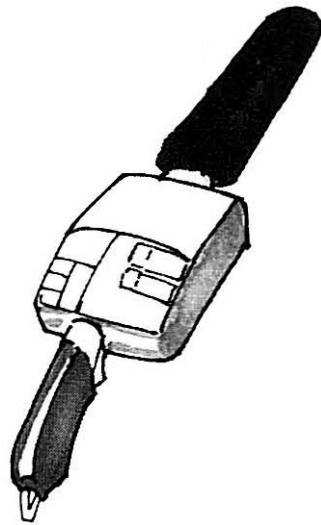

Motion Sensor Pack

Model: Zone Control Motion Security Scanner
Type: Motion detector
Skill: Sensors
Cost: 50
Availability: 2
Range: 25/50/100
Game Notes: Allows the user to detect motion up to 100 meters away.
Source: Rules of Engagement – The Rebel SpecForce Handbook (page 42)

Motion Sensor Array

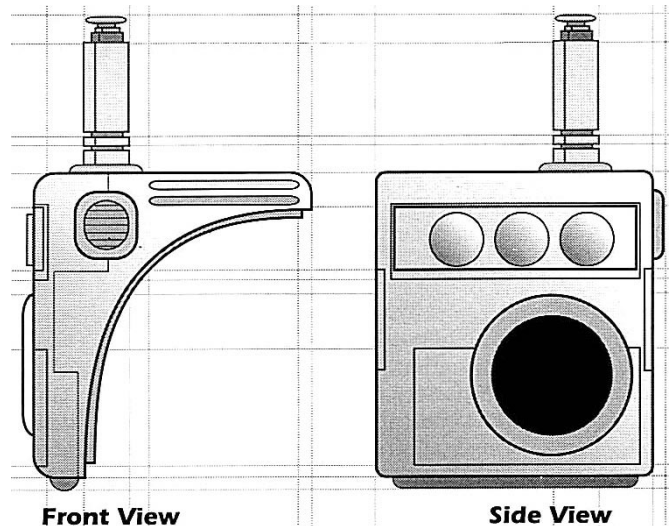

Surveillance Pod

Model: Taptronics CovOps mark III Surveillance Unit
Type: Concealed surveillance pod
Scale: Character
Skill: Sensors
Cost: 8,000
Availability: 2, R
Body: 1D
Game Notes: The Taptronics CovOps Mark III Surveillance unit – independently powered listening and tracking devices – add +2D to the *sensors* roll of the character operating it. In auto-function mode, the Mark III should be treated as if it has *sensors* 4D, automatically raising an alert if it detects an unauthorized motion, heat or sound source.
Source: Hideouts & Strongholds (pages 52-53)

Model: NeuroSaav MacroMotionMonitor
Type: personal motion detector
Cost: 40
Availability: 3
Game Notes: Adds +1D to *search* rolls involving motion up to 50 meters away.
Source: Galaxy Guide 10: Bounty Hunters (page 91), Gundark's Fantastic Technology (page 64)

Gotal Electromagnetic Scanner

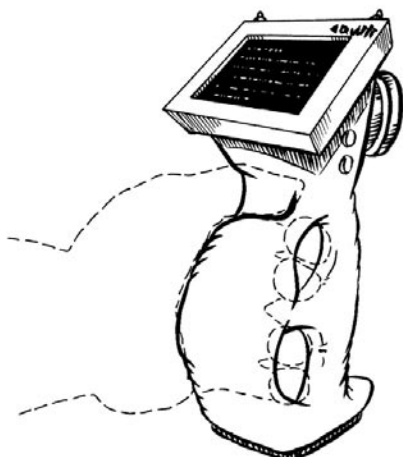

Model: Vreshann Electronics, Incorporated EMS Scanner

Type: Electromagnetic radiation scanner

Skill: Sensors

Cost: 2,500

Availability: 3

Game Notes: A Moderate *sensors* roll is required to detect electromagnetic emissions within a 100 meter radius. A Difficult *sensors* roll is required to detect life-forms behind walled enclosures or other blocking materials. Information readouts are limited to providing data on the number of persons present, approximate size and mass.

Source: Galladinium's Fantastic Technology (page 61)

Lifedetec Bioscanner

Model: Cryoncorp Lifedetec Bioscanner

Type: Bioscanner

Cost: 2,800

Availability: 2

Range: 500/1/1.5 km

Game Notes: The portable scanner detects the presence of lifeforms and pinpoints their location. This scanner can even determine the species of a lifeform if species templates are loaded into the lifeform indicators.

Source: Gundark's Fantastic Technology (page 103)

ILF-5000 Lifeform Scanner

Model: Idellian Arrays ILF-5000 Lifeform Scanner

Type: Lifeform scanner

Skill: Sensors

Cost: 3,500

Availability: 2

Range: 500/1/1,5 km

Game Notes: A *sensors* roll is required to use the device; the difficulty depends upon the conditions as described in the sensors rules in the *Star Wars Adventure Journal*. In addition to providing the number of lifeforms detected, and rate and direction of movement, the unit will inform the user if the body function parameters match or are similar to any lifeforms pre-programmed into the unit's database.



The unit will inform the user of the detected target's body temperature, mass and respiration rates. User may make an *alien species* or *beast riding* total to determine which lifeform is detected if such an attempt is reasonable in the gamemaster's opinion.

Source: Galladinium's Fantastic Technology (page 55)

Lifeform Scanner



Model: Idellian Arrays ILF-5500

Type: Lifeform scanner

Skill: Sensors

Cost: 3,500

Availability: 2

Range: 500/1/1.5

Game Notes: 4D *alien species* programming for identification. If the species is unidentified, the user may attempt an *alien species* roll.

Source: Rules of Engagement - The Rebel SpecForce Handbook (page 42), Arms and Equipment Guide (page 90)

Sensor Pack

Model: NeuroSaav 8932/D Sensor Pack

Type: Portable scanning device

Skill: Sensors

Cost: 650

Availability: 2, R

Game Notes: The NeuroSaav 8932/D is a general-purpose sensor apparatus that can detect either the presence of a life form, or the presence of a comm. signal. Characters using the unit receive a +1D bonus to *sensors*. The device can scan up to 300 meters away, and will give approximate bearings to the source of a comm. transmission or the location of a life form.

Source: Rulebook (page 227), Arms and Equipment Guide (page 90)

Audio Pickup

Model: NeuroSaav TeleSonic Model Audio Pickup

Type: Specialized audio-magnification device

Skill: Sensors

Cost: 450, 10 per replacement datacard

Availability: 2

Range: 50-100/250/500

Game Notes: Easy to detect noise, Moderate to magnify, and Difficult to filter, plus one level of Difficulty per range band.

Source: Rules of Engagement - The Rebel SpecForce Handbook (page 41), Arms and Equipment Guide (page 90)

"EAR" Eavesdropping Unit



Model: EAR-1 Unit

Type: Eavesdropping electrobug and listening device

Cost: 750 (each bug), 1,000 (handset), 2,500 (microcomputer & recording unit)

Availability: 2, R

Game Notes: After planting one of the thumbnail-sized bugs on a target or location, the microcomputer unit can pick up its signal within 200 meters, but only in line of sight. Using a headset, the bug acts as a microphone, collecting conversations or sounds and sending them to the microcomputer. The microcomputer records and saves information, both in audio and a hardcopy.

Source: Lord of the Expanse – Sector Guide (page 46)

Comm Scanner

Model: Courier Communications Scanner

Type: Comm detector and scanner

Skill: Sensors and communications

Cost: 2,500

Availability: 2, R

Game Notes: Allows user to detect and tap into com transmissions.

Source: Rules of Engagement – The Rebel SpecForce Handbook (page 42), Arms and Equipment Guide (page 89)

Orbital Transmission Monitor

Model: Arantha Communications OTM-900

Type: Subspace receiver

Skill: Communications

Cost: 550

Availability: 2



Game Notes: Instantaneous reception up to a range of 15 light-years. An Easy to Very Difficult *communications* roll is required to find specific frequencies (difficulty varies based on organization; planetary customs may be fairly easy to find but Imperial military communications channels are carefully hidden and knowledge of their frequencies is a closely guarded secret). Decrypting scrambled codes or translating from other languages is another matter entirely.

Source: Galladinium's Fantastic Technology (page 45)

Energy Scanner

Model: Fabritech 9000 Energy Scanner

Type: Energy scanner

Cost: 5,600

Availability: 2

Range: 500/1/2 km

Game Notes: Capable of detecting many forms of energy emissions and provide data on type, intensity, effects, and origin.

Source: Gundark's Fantastic Technology (page 102)

PX-7 Heat Sensor

Model: Chandriltech PX-7 Heat Sensor

Type: Hand-held heat sensor

Skill: Sensors

Cost: 250

Availability: 4

Game Notes: Detects heat sources in a 100-meter radius. Heat intensity is indicated by brightness of image on readout screen.

Source: Galladinium's Fantastic Technology (page 32), Arms and Equipment Guide (page 89)

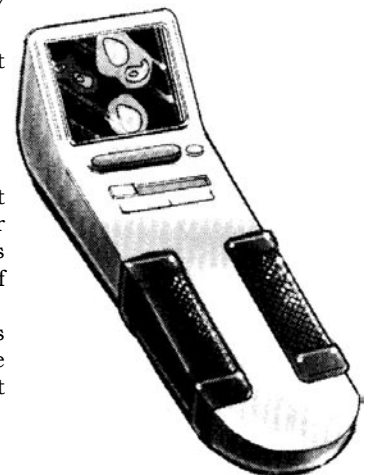

Food Analyzer

Model: SuriTech Foodstuffs Ez1 Analyzer

Type: Personal food analyzer
Cost: 250, 50 (additional data chips), 100 (customized data chips)

Availability: 2

Game Notes: A Very Easy *survival* roll is required for normal operation. The user will typically purchase additional data chips (up to a maximum of 5 can be added at any time) which provide information on additional entrees. Persons suffering from reactions to specific foods or food additives may purchase customized datachips designed to examine for specific components and warn against possible allergic reactions.

Source: Galladinium's Fantastic Technology (pages 65-66), Arms and Equipment Guide (page 91)

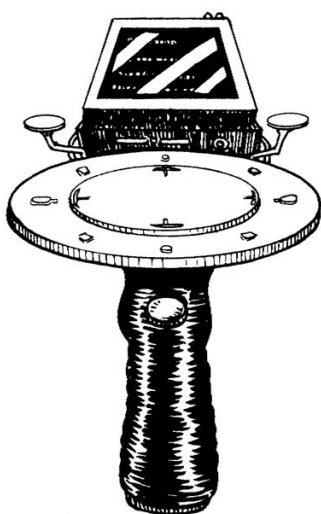

Sniffer

Model: Neuro Saav ChemDetect

Type: Chemical detection and identification device

Skill: Sensors

Cost: 1,500

Availability: 2

Game Notes: Range highly variable, depending on wind conditions, humidity and the presence of other chemicals.

Source: Rules of Engagement - The Rebel SpecForce Handbook (page 41), Arms and Equipment Guide (page 90)

BlasTech Sniffer Weapons Detector

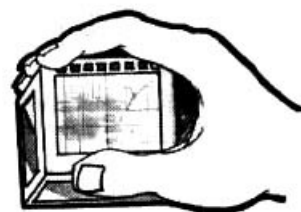
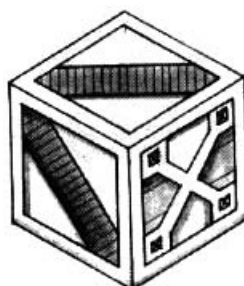

Model: BlasTech Sniffer Weapons Detector

Type: Portable weapon detector

Cost: 5,600

Availability: 2, R (restricted to governments)

Game Notes: Has a *search* of 5D to detect hidden energy weapons or adds +2D to an operator's *search: weapon detector* skill (the operator must have at least 1D in this specialization to qualify for the bonus). The difficulty depends on how well someone has camouflaged the weapons: simply putting it in a pack is an Easy difficulty; draining all the blaster gas, pulling out the power packs, cleaning the weapon of all residue and then disassembling it, and spreading the parts among several pieces of luggage, would be a Very Difficult difficulty.

Source: Gundark's Fantastic Technology (pages 101-102), Han Solo and the Corporate Sector Sourcebook (page 116)

ChaumScanner 5 Brooch

Model: Zzip Personality Series ChaumScanner 5

Type: Poison detector

Cost: 6,540

Availability: 3, F (standard model), 4, R (luxury version)

Game Notes: The food scanner itself has a 4D *search* to detect any chemical or biological toxins. If specially programmed with the owner's unique biochemistry (allergies and the like), its skill goes to 7D. It produces a distinctive rhythmic vibration (detectable only by the wearer) when it detects a toxic substance. The wearer may make a Moderate *cultures* roll to seem inconspicuous when rejecting the poisoned food or drink.

Source: Cracken's Rebel Field Operatives (page 34)

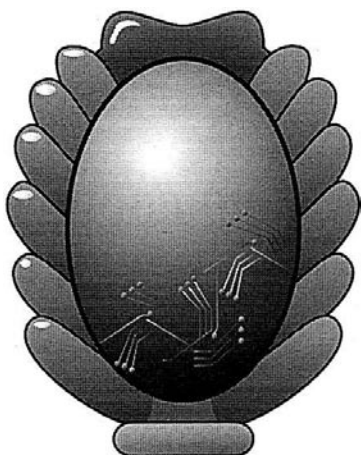

CorSec Autoscan Weapon Detector

Model: CorSec Autoscan Weapons Detector

Type: Stationary weapons detector

Cost: 7,200

Availability: 2, R (restricted to governments)

Game Notes: Has a *search* of 6D to detect hidden energy weapons. The difficulty level to detect weapons depends on how well someone has hidden the weapon using their *hide* skill.

Source: Gundark's Fantastic Technology (page 102)

Tox Detector

Model: SuriTech Disposable Toximeter Patch

Type: Toxin detector

Cost: 20

Availability: 2

Game Notes: The detectors are flat, one-decimeter square metallic sticker patches with a slightly raised deep-blue circle in the middle. This circle changes color to a phosphorescent orange when exposed to any harmful gases.

Source: Platt's Smugglers Guide (pages 48-49)

Search-Scan 4 Security Scanner

Model: BlasTech Search-Scan 4

Type: Multi-capable security scanner

Cost: 9,800

Availability: 2, R (restricted to governments)

Range: 3/7/25

Game Notes: This scanner adds 1D to the *sensor* skill roll of its operator. It can help detect structural anomalies hiding

secret compartments, and can find energy signatures showing weapons, life forms, and energy sources within a confined area, such as a docking bay, cargo hold, or compartment.

Source: Gundark's Fantastic Technology (page 104), Adventure Journal 4 (page 262)

Veridicator

Model: Saldalith Manufacturing Veridicator 200

Type: Response analysis device

Skill: Sensors: personal sensors

Cost: 4,000

Availability: 4, R

Game Notes: An Easy *sensors* roll is required for normal use. Detection range is 5 meters within a 60-degree scanning arc. Device acts as a *Perception* check (4D+2) when rolled to detect possible falsehood. If target is aware of possible scans, the target can make a *willpower* roll to control natural biorhythms and disguise a lie.

Source: Galladinium's Fantastic Technology (page 37), Arms and Equipment Guide (page 91)

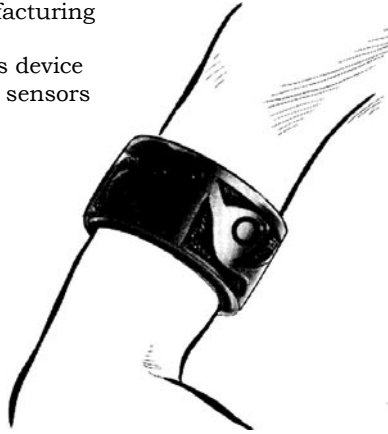

Force Detector



Model: Government Issue Force Detector Unit

Type: Imperial Force detector

Skill: Sensors

Cost: Not available for sale

Availability: 4, X

Game Notes: Use of the Force detector will tell a trained operator whether a subject is Force-sensitive, and whether he or she has any Dark Side Points (but not how many). Operating a Force detector requires 5 rounds and a Difficult *sensors* check.

Source: The Jedi Academy Sourcebook (page 140), Gundark's Fantastic Technology (page 102), Power of the Jedi Sourcebook (page 56)

Measuring Scanner

Model: Fabritech A-11 Cargo Scanner

Type: Handheld measuring scanner

Skill: Sensors

Cost: 150

Availability: 1

Game Notes: Using the scanner to calculate the size of cargo and cargo bays is a Very Easy *sensors* task, while the difficulty for using it for other purposes depends on the size, density and speed of the object being measured, usually no more than a Moderate task. The scanner has a range of 10 meters.

Source: Adventure Journal 4 (page 169)

Geological Scanner

Model: Fabritech 7000 Geoscanner

Type: Geoscanner

Cost: 4,800

Availability: 2

Range: 500/1/2 km

Game Notes: Can detect geological characteristics like precious minerals, ore deposits and underground features, as well analyzing geo-thermal, seismic, volcanic, and glacial activity.

Source: Gundark's Fantastic Technology (page 103)

Holographic Ore Scanner

Model: MicroThrust Holo Ore Scanner FR9

Type: Semi-portable ore scanner

Skill: Sensors: mining

Cost: 5,000

Availability: 3

Sensors:

Search: 1 km/1D

Focus: 500/2D

Game Notes: Using the ore scanner requires a *sensors* roll.

Source: Flashpoint! Brak Sector (page 25)

Focused Uni-Direction Sensor Dish

Model: Melihat UniScan Sensor System

Type: Focused uni-direction sensor dish

Skill: Sensors: uni-direction sensor dish

Crew: 5, skeleton: 3/+10

Cost: 7,800 (new), 3,600 (used)

Availability: 2, R

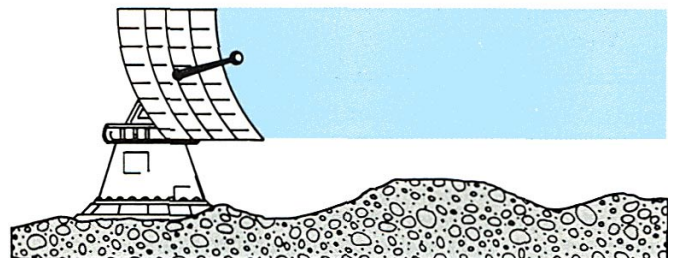

Game Notes: Has a maximum range of 10 kilometers. Can only provide information on a small focused area: 100 meters wide by 100 meters long by 20 meters high, adding +2D to the user's *sensors* skill to identify targets only. However, this sensor provides no bonus in rough, hilly, mountainous, cluttered urban or other terrains that targets could use obstacles to hide behind.

Source: Rebel Alliance Sourcebook (page 106)

Omni-Directional Sensor Globe

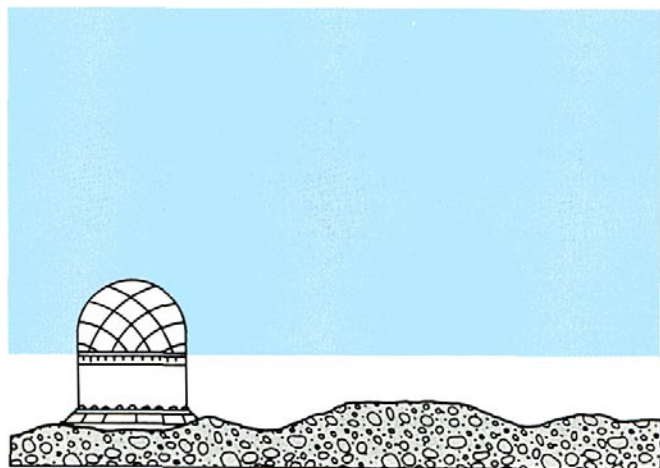

Model: Siep-Irol GlobeScan

Type: Omni-directional sensor globe

Skill: Sensors: omni-directional sensor globe

Crew: 10, skeleton: 4/+10

Cost: 12,500 (new), 6,250 (used)

Availability: 2, R

Game Notes: Scans in a 20 kilometer radius in all directions (including into the atmosphere). Adds +1D to the user's *sensors* skill to detect targets only. However, this sensor provides no bonus in rough, hilly, mountainous, cluttered urban or other terrains that targets could use obstacles to hide behind.

Source: Rebel Alliance Sourcebook (page 106)

Omniprobe Sensor Array



Model: tana Ire GroundSweeper-3

Type: Omniprobe sensor array

Skill: Sensors: omniprobe sensor array

Crew: 5, skeleton: 2/+15

Cost: 18,000 (new), 12,000 (used)

Availability: 2, R

Game Notes: Scans in a five kilometer radius up to a maximum height of two meters. Adds +1D to the user's *sensors* skill to detect targets only, and rough terrain provide no protection (as it does with other types of sensors).

Source: Rebel Alliance Sourcebook (page 106)

Installation Sensor Array

Model: NeuroSaav 9954/I Sensor Array

Type: Installation-level sensor package

Skill: Sensors

Crew: 3

Cost: 5,000

Availability: 2, R

Game Notes: Consists of a central processing computer and over 50 sensor dishes. Includes a powerful full-spectrum transceiver (FST) capable of picking up basic information from as far away as low orbit; this range can be increased by the addition of Sensor Relay Satellites (2,000 credits each). The array also has a dedicated energy receptor (DER) for detecting energy use and fluctuation, and a hyperwave signal interceptor (HSI). A life form indicator (LFI) is available for an additional 1,000 credits.

Source: Hideouts & Strongholds (page 12)

Sensor Array

Model: Fabritech LongView-382.X

Type: Long range sensor array

Skill: Sensors

Crew: 2

Cost: 110,000

Availability: 2, R

Game Notes: The sensor array can scan as far as 10 Space Units from the planet. Sensor operators add +1D to *sensors*.

Source: Hideouts & Strongholds (page 95)

Tracking Devices

Personal Transponder

Model: zZip Product Concepts Limited Transponder Ring
Type: Personal location detector
Cost: 100-500 (depending on setting design selected)
Availability: 2
Game Notes: A Very Easy *sensor* roll is required to locate transponder signal within a 200 meters radius.
Source: Galladinium's Fantastic Technology (page 36)



Tagger

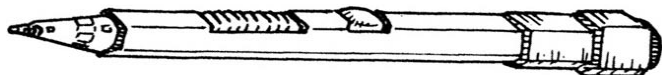

Model: Culcanis MicroInstruments Tagger
Type: Remote surveillance tracking tool
Cost: 250
Availability: 3, F
Game Notes: The business end of the tagger is a small (5 mm) transponder dart. The tagger stylus has a small amount of pressurized gas to silently propel the transponder up to 5 meters. Once attached to its target, the device broadcasts an intermittent (once every 5 minutes) signal which can be picked up 1.2 kilometers away. Dart operates up to 40 standard hours.
Source: Galladinium's Fantastic Technology (page 62), Arms and Equipment Guide (page 87)

Trailmaster Tracking Device

Model: Astroserver Trailmaster
Type: Personal tracking device
Skill: Search
Cost: 400
Availability: 2
Range: 1 kilometer
Game Notes: Tracker only gives direction. *Search* is one difficulty easier when beacon is within tracker's range.
Source: Cracken's Rebel Field Guide (page 21)

Observer Tracking Device

Model: MechBlaze Tracking Corp. Observer
Type: Personal tracking device
Skill: Search
Cost: 500
Availability: 2
Range: 1 kilometer
Game Notes: Tracker only gives direction and range from beacon. *Search* is one difficulty easier when beacon is within tracker's range.
Source: Cracken's Rebel Field Guide (page 21)

Rover Tracking Device

Model: Astroserver Industries Rover
Type: Personal tracking device
Skill: Search
Cost: 1,000
Availability: 2
Range: 3 kilometers
Game Notes: Tracker tells range, direction and speed of beacon. *Search* is one difficulty easier when beacon is within tracker's range.
Source: Cracken's Rebel Field Guide (page 21)

SureSnoop Tracking Device

Model: Rhinsome Tracking Corp. SureSnoop
Type: Personal tracking device
Skill: Search
Cost: 3,000
Availability: 4
Range: 5 kilometers
Game Notes: Top of line. Give exact range, direction and speed of beacon. *Search* is one difficulty easier when beacon is within tracker's range.
Source: Cracken's Rebel Field Guide (page 21), Arms and Equipment Guide (pages 90-91)



Slave Tracking Device

Model: Hutt Slave Tracking Device
Type: Implanted tracking device/explosive
Scale: Character
Cost: Not usually available for sale
Availability: 3, X
Damage: 5D (to the slave only)
Game Notes: These devices are implanted into the bodies of slaves to prevent them from escaping. If the slave travels beyond the range of his owner's tracking transmitter, the device triggers a small explosion. The transmitter has a range of 50 kilometers, but can be calibrated down depending on the owner's needs. The tracking device is most often implanted while the slave is sedated. The device is hard to locate, requiring a specialized scanner and a Heroic *security* skill check. These scanners are not commercially available. In order to deactivate the tracking device, the tracking transmitter is required. With the proper codes, the required *security* skill check is Easy difficulty. Without the codes, the difficulty is increased to Heroic. If tampered with, or if the slave attempts to leave the transmitter's range, the slave begins to take damage as the tracking device begins to heat up: 1D damage the first round, 2D on the second, and 3D on the third. If the slave does not rectify his behavior, the device will explode on the fourth round, doing 5D of damage to the slave.
Source: Secrets of Tatooine (page 37)

"Keeper" Vec-Tech Subdermal Control System

Model: Vector technologies AA-2 Keeper
Cost: 5,000
Availability: 4, X
Range: 25 kilometers
Game Notes: A beacon is surgically implanted under

the victim's skin. It can only be removed by the being in possession of the tracker unit, who must first enter a password. Any other attempt to extract the beacon results in the release of an exotic neurotoxin that kills instantly (8D damage). The tracker can tell the range, direction, and speed of the target, up to a range of 25 kilometers. There's no need to worry about the target after that, because if he or she moves beyond that range, the beacon releases the neurotoxin automatically.

Source: Wretched Hives of Scum and Villainy (page 77)

Crab Tracer

Model: Crab Tracer

Type: Tiny self-guided tracking device

Cost: 3,000

Availability: 3, X

Game Notes: Unit is programmed to sneak onto a target and transmit its location though HoloNet with a miniaturized hypertransceiver. Unit possesses the *sneak* and *hide* skills at 5D and are remotely controlled. They can be deactivated with a Moderate *computer programming/repair* roll. A crab tracer aboard a ship sends a strong enough signal to be tracked through hyperspace, and grants a +2 bonus to starship attacks made against the tracked vessel.

Source: Tempest Feud (page 127)

ShipFinder

Model: Drooin-Durtha Systems ShipFinder

Type: Subspace tracking device

Skill: Sensors

Cost: 100,000

Availability: X

Game Notes: Use of the ShipFinder requires an Easy *sensors* roll. If successful, the character can locate the tracking device and plot a course to it from her present coordinates. Tracking device's power cells last only eight days once activated.

Source: Classic Adventures – Vol. 4 (page 59)

Imperial XX-23 S-Thread Tracker

★: CODED TRANSMISSION POINTS
(WHERE SHIP INTERSECTS S-THREAD)

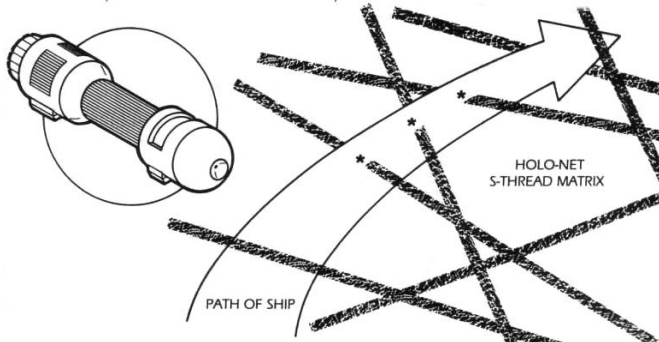

Model: Imperial XX-23 S-Thread Tracker

Type: Hyperspace ship tracker

Skill: Astrogation

Cost: Not available for sale

Availability: X

Difficulty: Difficult

Range: Unlimited

Game Notes: Imperials may make on *astrogation* roll per hour to track ship. In hyperspace, only the general direction of the ship may be found. Once in normal space, the ship may be tracked to within one parsec. Tracker is too powerful at ultra-high frequencies to find exact location, and system in question must be searched with conventional means. Tracker is a 10 cm long tube. May be easily destroyed if found. In no way interferes with normal communications or cannot be detected by such means.

Source: Cracken's Rebel Field Guide (page 62)

Anti-Surveillance

Dalabar Surveillance Detector

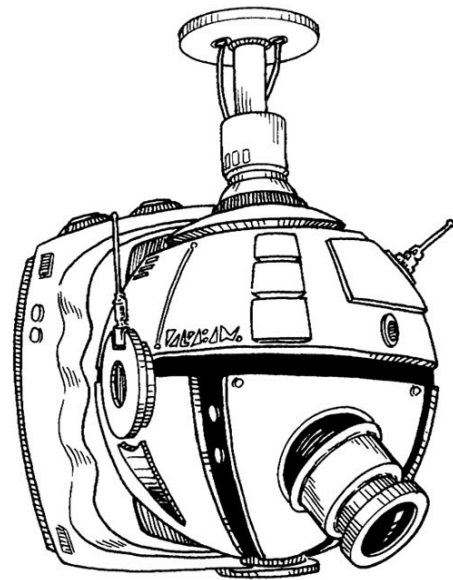

Model: Dalabar Micro-Electronics SDS-632

Type: Personal surveillance detector

Skill: Sensors

Cost: 450

Availability: 3

Game Notes: The SDS-632 scans an area with a *sensors* skill of 5D. For an additional 175 credits, the optional noise inhibitor (NI-632) blocks aural receptors by blanketing a 10-meter diameter area with sonic disturbances to match the frequency of the sensors detected.

Source: Galladinium's Fantastic Technology (pages 59-60), Arms and Equipments Guide (page 89)

Smoke Generator

Model: GFBS SFX Smoke Generator

Type: Mood effects stage smoke generator

Cost: 40

Availability: 2

Game Notes: Adds +2D of cover to blaster firer's difficulty. Adds +1D to difficulty with physical weapons (due to obscurity).

Source: Rules of Engagement – The Rebel SpecForce Handbook (page 44)

Instamist Generator

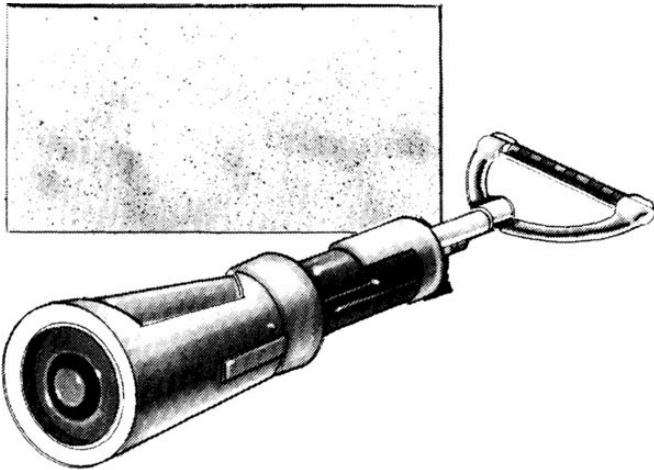

Model: Agrierd Intergalactics InstaMist Generator
Type: Mist generator
Cost: 15 (dispenser), 10 (mist cartridge)
Availability: 2
Game Notes: Can generate a fire extinguishing mist which turns into a smothering foam, water mist for desert conditions, or a misty fog to provide cover.
Source: Galladinium's Fantastic Technology (page 33)

Camo-Netting

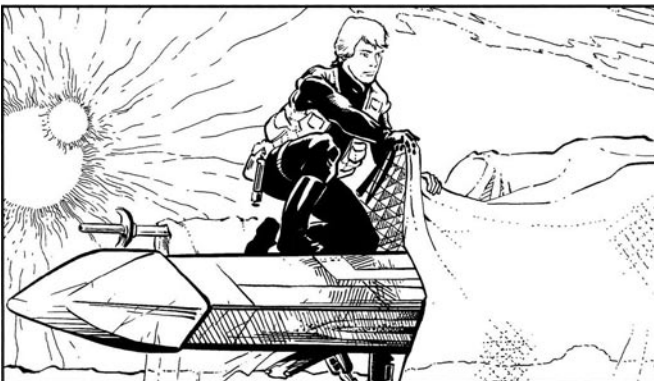

Model: Fabritech CN-15 Camouflage Netting
Type: Camo-netting
Skill: Hide
Cost: 3,500
Availability: 2, R
Game Notes: Camo-netting adds +2D to the difficulty to detect the camouflaged object with sensor-scanning equipment at ranges greater than 250 meters. Camo-netting offers no bonus at a range of less than 250 meters. If more than three camo-nets are used in tandem, the sensor-scanning equipment gains a +1D to detect the nets because of the interference the nets cause.
Source: Gundark's Fantastic Technology (page 106-107), Rules of Engagement – The Rebel SpecForce Handbook (page 44), Shadows of the Empire Sourcebook (pages 110-112), Arms and Equipment Guide (page 92)

View Masker

Model: zZip Product Concepts PSG-8487 View Masker
Type: Portable distortion field
Cost: 2,500, 50 (power cells), 100 (sensor alarm module)
Availability: 3, F, R or X
Game Notes: With voice code activation, it creates a localized visual distortion field (1 meter in diameter) which makes visual or audio scans virtually impossible.
Source: Galladinium's Fantastic Technology (page 63)

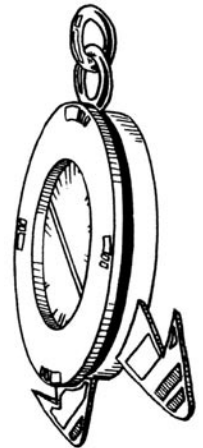

Voice Scrambler

Model: Ulkop Securities SVC-700 Voice Scrambler
Type: Voice scrambler
Cost: 600
Availability: 3
Game Notes: The voice scrambler distorts conversation so that more than three meters away it is impossible to determine the content of the conversation.
Source: Galladinium's Fantastic Technology (page 63)



Silence Bubble Generator

Model: Audio Performance Inc. Sheer Silence Bubble Generator
Type: Anti-surveillance device
Cost: 3,000
Availability: 2
Game Notes: *Sensor stealth* code of 4D to counter audio pickups; failure indicates the bubble itself is detected.
Source: Rules of Engagement – The Rebel SpecForce Handbook (page 44), Arms and Equipment Guide (page 91), Ultimate Adversaries (page 155)

Sound Bubble

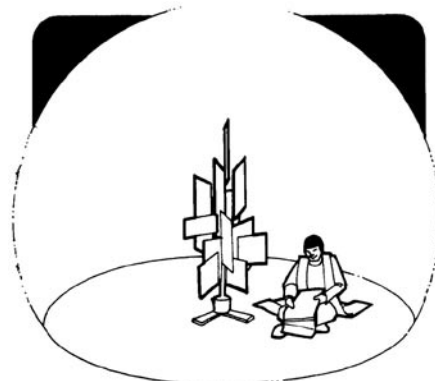

Model: Paretaine Sonics SNS-600
Type: Portable sound dampening system
Cost: 300
Availability: 3

Game Notes: An Easy *sensor* roll required for normal operation. Device can operate in two modes. In passive mode it produces a 360-degree field out to 5 meters. Sounds emitted outside this radius are “absorbed” – only sounds emitted from within the bubble are heard within the bubble. In activate mode, a 60-degree arc can be generated out to 10 meters. Within this arc, sound waves are effectively dampened, preventing any aural vibration from being sensed by live or automated detectors.

Source: Galladinium’s Fantastic Technology (page 46)

Disruption Bubble Generator

Model: Bakuran DB Generator
Type: Anti-surveillance device
Cost: 150,000 (Bakuran black market), 2,500-5,000 (elsewhere)

Availability: 4, F, R or X

Game Notes: The Disruption Bubble Generator is capable of producing a small, quiet area of interference to audio sensors. This bubble is generally 2 meters in diameter and can only be penetrated by a Very Difficult *sensors* roll. The DB generators still in circulation are extremely old and extremely fragile. They should be treated as having 1D *Strength* to resist damage. If Dropped, shot or handled roughly the DB must roll to resist damage. If the DB generator fails its *Strength* check, it is destroyed.

Source: The Truce at Bakura Sourcebook (pages 137-138), Gundark’s Fantastic Technology (pages 96-97)



Heat Pod

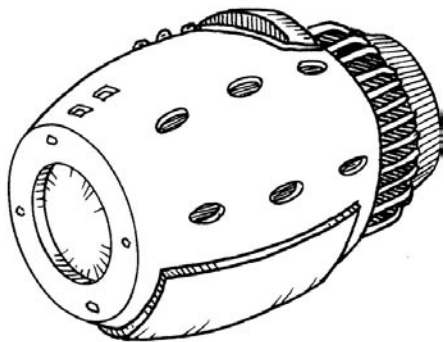

Model: Dalesepp Survival Apparatus HPD-100 Heat Pod
Type: Heat generator
Skill: Thrown weapons
Cost: 70
Availability: 3, F

Game Notes: Once employed, increases the difficulty of heat-based sensors or tracking systems by two levels (may vary depending upon type of information sought, distance from actual target and other factors).

Source: Galladinium’s Fantastic Technology (page 61)

Sensor No-Show

Model: Alliance No-Show/Individual criminal manufacture
Type: Passive field generators

Skill: Sneak

Cost: Not for sale (5,000 for similar black market units)

Availability: 4, X

Game Notes: No-show protect on individual, giving them +2D to *sneak* when pertaining to heat- and infrared-based sensors. A standard power cell is completely drained after 15 minutes of use.

Source: Galaxy Guide 11: Criminal Organizations (page 85), Rules of Engagement – The Rebel SpecForce Handbook (page 44), Arms and Equipment Guide (page 91)



Sensor Jammer

Model: IntelStar BlindSide Sensor Jammer

Type: Sensor jammer

Skill: Sensors

Cost: 5,000 plus installation

Availability: 2, X

Game Notes: To use this device, an opposed sensor contest is rolled between the scanner and the jammer, each one using its operator’s *sensors* skill. If the jammer wins, the scanner still knows he’s being jammed, though he can’t locate the source.

Source: Hideouts & Strongholds (page 12)

Sensor Scrambler

Model: Modified MicroThrust Com-Repeater

Type: Sensors disruption unit

Skill: Sensors

Cost: 1,175 (basic unit), 1,825 (jury-rigged unit)

Availability: X

Game Notes: Moderate *sensors* roll to foul sensors within 200 meters. Sensor operators attempting to descramble the signal must make a Difficult *sensors* roll.

Source: Rules of Engagement – The Rebel SpecForce Handbook (page 44)

Sensor Blind

Model: IntelStar Tranquility System I

Type: Sensor blind

Skill: Sensors

Cost: 400,000

Availability: 4, X

Game Notes: To use the sensor blind, the operator must engage in an opposed roll with the operator of the scanning sensors. If the blind’s operator beats the opposing sensor operator by more than 5, then the scanner receives a false reading. In densely populated areas, give the blind’s operator a +1D bonus to his roll.

Source: Hideouts & Strongholds (page 12)

Security

Sensor Trips

Pressure Plate Trip

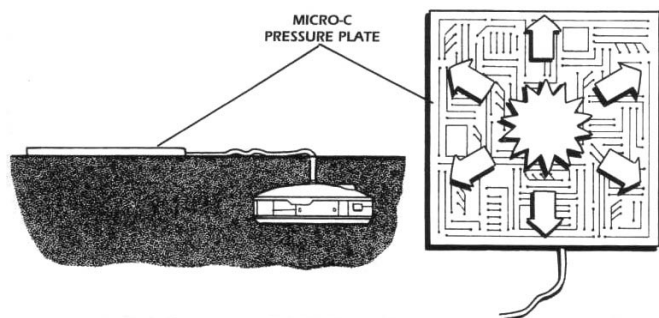

Model: Zone Supplies, Ltd. Pressure Plate Trip
Type: Trip sensor
Skill: Sensors
Cost: 300
Availability: 2, F
Game Notes: Two sizes available: one-third meter by one-third meter, and one meter by one meter. Small trips weigh 300 grams, and large trip weigh one kilogram. Power pack lasts 72 hours. Characters must make a *search* roll to detect the trips. A Moderate roll is necessary to spot the large trip, while a Difficult roll is necessary to spot the small trip. Any pressure triggers the plate; can be set to trip at minimum weights. Can be attached to blasters, bombs or alarms.
Source: Cracken's Rebel Field Guide (page 20), Rules of Engagement – The Rebel SpecForce Handbook (pages 42-43)

Laser Detection Trip

Model: Merr-Sonn LCT Laser Trip
Type: Laser emplacement trip
Skill: Computer programming/repair
Cost: 350
Availability: 2
Game Notes: If tied into a computer system, the trips detect living beings passing through its beam.
Source: Shadows of the Empire Planets Guide (page 84)

Repulsorfield Trip

Model: Zone Supplies, Ltd. Repulsor Trip
Type: Trip sensor
Skill: Sensors
Cost: 500
Availability: 2
Game Notes: Can be set to trip to minimum field intensities.
Source: Rules of Engagement – The Rebel SpecForce Handbook (page 43)

Motion Sensor Trip

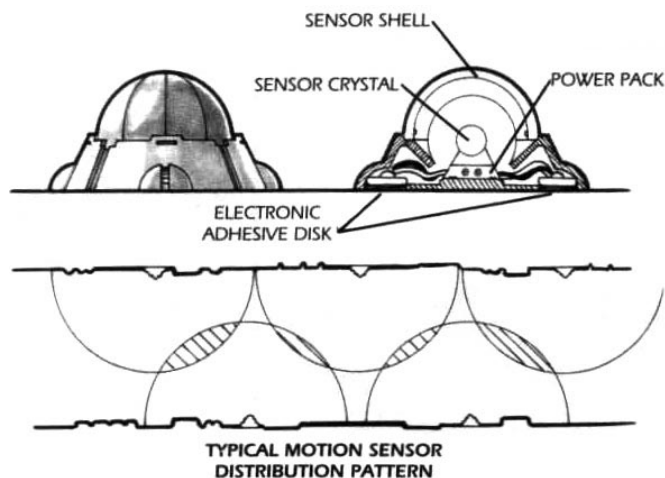

Model: BlasTech MoveSense 34 Motion Trip
Type: Trip sensor
Skill: Sensors
Cost: 100
Availability: 2, F
Range: 4 meters, 180-degree dome arc
Game Notes: Finding sensor requires Difficult *security* roll. Sneaking by a motion sensor trip requires a Difficult *sneak* roll. Alarm emits a piercing shriek when triggered by any motion above 0.2 meters-per-second. Can be remotely turned on and off with calibrated security systems. System must have transmitter within 50 meters of sensor. Unit is cubed, six centimeters to a side.
Source: Cracken's Rebel Field Guide (page 19), Rules of Engagement – The Rebel SpecForce Handbook (page 42)

Heat Sensor Trip

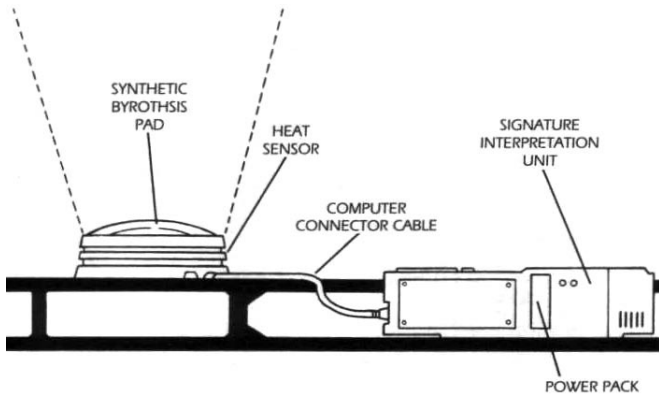

Model: Imperial Heat Sensor Trip

Type: Trip sensor

Cost: Not available for sale

Availability: X

Range: 20 meters, 45-degree arc

Game Notes: Sensors can be programmed to set off alarms or notify a central computer. Character must disable heat sensor or successfully disguise his heat pattern as a proper shape and heat pattern to pass by undetected. Sensor connected to computers by 50-meter long cable, although multiple cables can be connected for greater range.

Source: Cracken's Rebel Field Guide (page 18)

SoroSuub Heat Sensor Trip

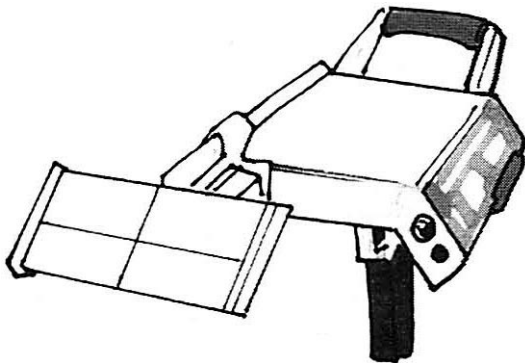

Model: SoroSuub Heat Sensor

Type: Heat sensor

Skill: Sensors

Cost: 100

Availability: 2

Range: 20 meters, 45-degree arc. Has a variable trigger mechanism; can be set to trip if it detects a heat source with a temperature ranging from three to thirty degrees standard.

Source: Rules of Engagement - The Rebel SpecForce Handbook (page 42)

Defense

Stun Steps

Model: Telex-Delcor Ramp Entry Security System

Type: Anti-boarding security device

Scale: Character

Cost: 1,500, 500 for each additional die of stun damage past 3D up to 5D

Availability: 2, F

Damage: 3D-5D stun damage

Source: Adventure Journal 13 (page 158)

Monofilament Screen Guards

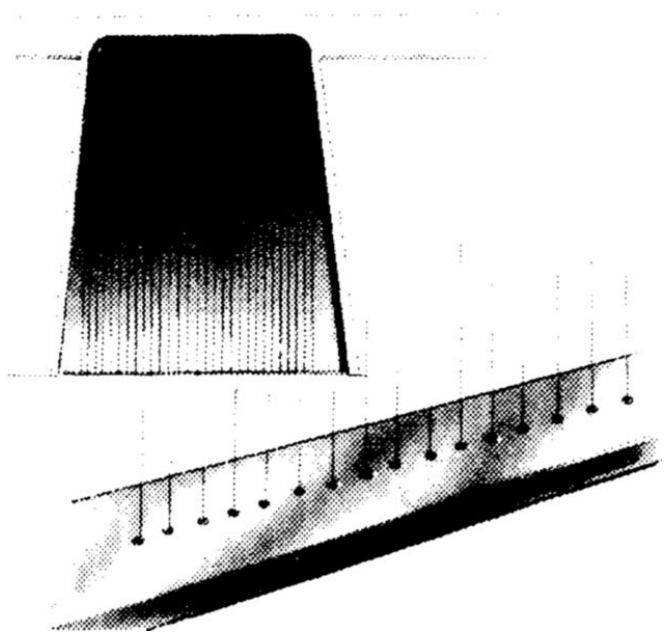

Model: Novaplex Monofilament Screen Guards

Type: Anti-intrusion device

Cost: 450 (1 pair 80 centimeter long strips)

Availability: 4, F, R or X

Game Notes: An intruder must make a Very Difficult *search* roll to detect strips in place. Contact with the strips causes 6D damage (if the subject is moving rapidly when contact is made, increase the damage to 9D)

Source: Galladinium's Fantastic Technology (pages 31-32), Arms and Equipment Guide (page 94)

Locking Systems

Imperial Customs Holoseal

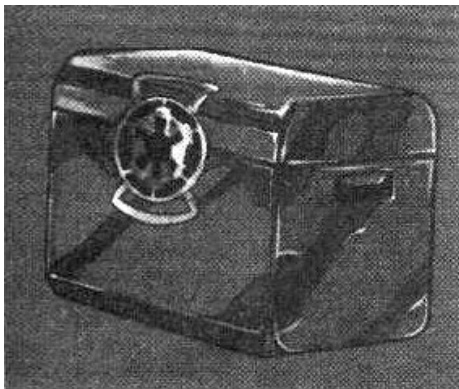

Model: MerenData Imperial Holoseal
Type: Customs holoseal
Cost: Not available for sale
Availability: 2, R
Game Notes: Successfully removing an Imperial holoseal is a Very Difficult *security* task. Other seals used by sector and system customs authorities can be removed with Moderate to Difficult *security* roll.
Source: Platt's Smugglers Guide (page 51)

Magna Lock

Model: Locris Syndicates MLC-50
Type: Surface locking mechanism
Skill: Security
Cost: 150
Availability: 2
Game Notes: A Very Easy *security* roll is required to activate the unit in place. The device adds +2D to an object's *Strength* to resist damage.
Source: Galladinium's Fantastic Technology (page 31), Arms and Equipment Guide (page 94)

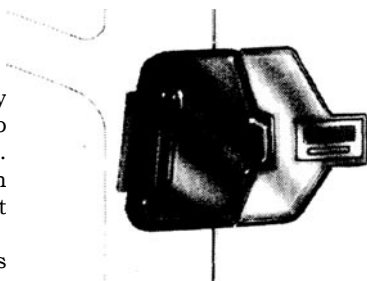

Bith Computer Retinal Lock

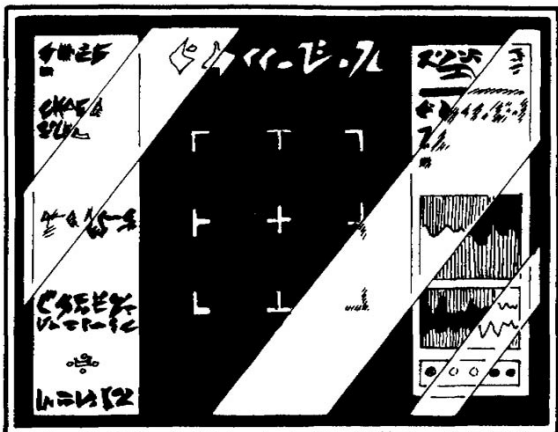

Model: Veredictas CompuTechnology Bith Computer Retinal Lock
Type: Computer security system
Skill: Computer programming/repair
Cost: 1,200
Availability: 3
Game Notes: An Easy *computer programming/repair* roll is required for installation. Once in place, only retinal falsification system will allow unauthorized users to access secured files.
Source: Galladinium's Fantastic Technology (page 59)

Bith Vehicle Voice Lock

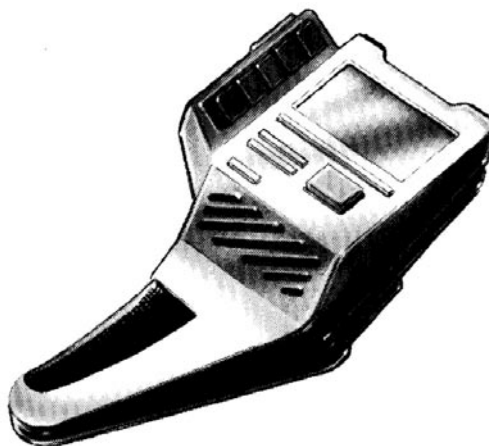

Model: Casilis Electronics Defenses BiVVoL RVR-325
Type: vehicle theft deterrent
Skill: Streetwise
Cost: 650
Availability: 3
Game Notes: An Easy *communications* total is required to properly encode the BiVVoL or change an established pattern. Normal activation by the owner with voice command code is automatic within a 10-meter range (if the owner is willing). The owner can alter the command sequence's tone to fail an activation if under duress. A failed attempt to circumvent a BiVVoL means that the vehicle's power system is disabled until the secondary system establishes identity. Attempting to "forge" a voice replication requires a voice replication unit with sound adjustment functions, at least three hours of work creating the forgery, and a Moderate *communications* roll and a Moderate *forgery* roll.
Source: Galladinium's Fantastic Technology (pages 12-13)

Key Card Ship's Lock

Model: Aratech Cradset System
Type: Code key lock
Cost: 1,000
Availability: 2, F
Game Notes: Installing this lock yourself requires a Difficult *security* roll. Failure means the lock sometimes sticks, and sometimes doesn't engage all the way. Most key card locks come with two imprinted cards. Bypassing this lock requires a Very Difficult *security* roll.
Source: Platt's Smugglers Guide (pages 55-56)

Electronic Combination Hatch Lock

Model: Varge Corp. Cipher Security Seal

Type: Combination hatch seal

Cost: 750

Availability: 2, F

Game Notes: Installing this lock yourself requires a Difficult *security* roll. Failure means the lock sometimes sticks, and sometimes doesn't engage all the way. Bypassing this lock requires a Difficult *security* roll.

Source: Platt's Smugglers Guide (pages 55-56)

Remote Control Hatch Lock

Model: Varge Corp. Ranged Lock

Type: Remote control seal

Cost: 1,250

Availability: 2, F

Game Notes: Installing this lock yourself requires a Very Difficult *security* roll. Failure means the lock sometimes sticks, and sometimes doesn't engage all the way. The remote control unit has a range of 30 meters. Bypassing this lock requires a Very Difficult *security* roll.

Source: Platt's Smugglers Guide (pages 55-56)

Console Lock Panel

Model: Varge Corp. CS20 Board Plate

Type: Control lock panel

Cost: 300 (electronic combination), 500 (key card)

Availability: 2

Game Notes: Installing the panel assembly yourself requires a Difficult *security* roll. Failure means the lock sometimes sticks, and sometimes doesn't engage all the way. Bypassing the lock requires a Moderate *security* roll. To engage or remove the panel takes six rounds.

Source: Platt's Smugglers Guide (page 56)

Console Dead Lock

Model: Arakyd PowerLock 2500

Type: Console power lock

Cost: 1,000 (electronic combination), 1,500 (key card)

Availability: 2

Game Notes: Cuts the energy feed to your control boards. Installing the lock yourself requires a Very Difficult *security* roll. Failure damages some of the cockpit, instrumentation and controls. Bypassing the lock requires a Very Difficult *security* roll.

Source: Platt's Smugglers Guide (page 56)

Storage Devices

Spacer's Chest

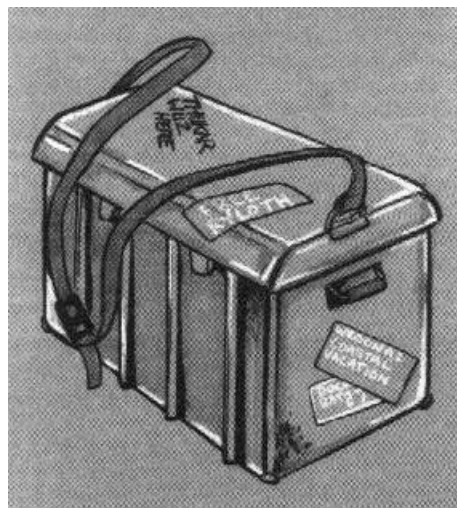

Model: SoroSuub Wanderer Space Chest

Type: Spacer's chest

Cost: 200 credits

Availability: 1

Game Notes: A rectangular, 1 meter long chest, with handles on each face. It can be locked with an electronic combo-lock (Moderate to pick), sealed against vacuum, and is quite durable: 6D *Strength*.

Source: Platt's Smugglers Guide (page 46), Gundark's Fantastic Technology (pages 76-77), Pirates & Privateers (pages 47-48)

Sleight Box

Model: Ecls Industries R-Roll Crate

Type: Sleight box

Cost: 750-2,000

Availability: 3, X

Game Notes: These cargo containers have a low-powered repulsorlift coil matrix and power supply cleverly concealed in the bottom casing. A small compensator c-board helps the repulsorfield neutralize the weight of anything inside, making the box feel like it's empty. Scans detect a sleight box's energy source on a Difficult *sensor* roll; increase the difficulty one level if the container is stowed near another power source.

Source: Platt's Smugglers Guide (pages 52-53)

Bith Hiding Cube

Model: Veretrex Securities Hiding Cube SCT-1000

Type: Security container

Cost: 3,000

Availability: 4

Game Notes: Cube is 75 centimeters on a side. When activated and properly hidden, a viewer must make a Moderate *Perception* roll to notice "something" about the wall where the cube is. External magna-locks along the container surface require a Very Difficult *security* total to pick. The container's outer surface has a *Strength* of 4D to resist damage.

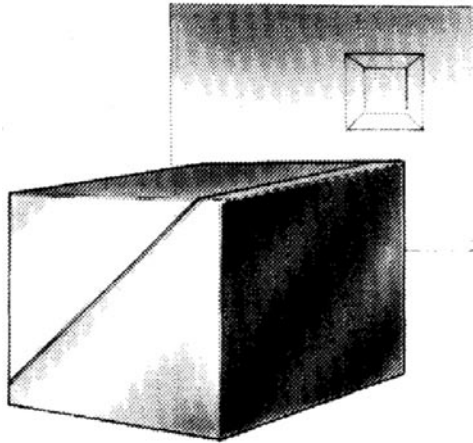

Source: Galladinium's Fantastic Technology (page 28)

Chronometer with Hidden Compartment



Model: Alliwon Electronics Vennoc-x Chronometer
Type: Personal chronometer
Cost: 50, 65 (belt version)
Availability: 1
Game Notes: Hidden compartment can hold items smaller than four by four centimeters.
Source: Galladinium's Fantastic Technology (page 44), Arms and Equipment Guide (page 96)

Thermal Credit Belt

Model: Novaplex Security Belt
Type: Money belt
Cost: 100
Availability: 2
Game Notes: If worn with a blast vest or other torso armor, the user suffers -2 to *Dexterity* and related skill rolls.
Source: Platt's Smugglers Guide (page 48)

Restraining Devices

Binder Cuffs

Model: Loris Merr-Sonn Binder Cuffs
Type: Personal restraint device
Cost: 50
Availability: 1
Game Notes: Binder cuffs have a *Strength* of 5D to hold individuals.
Source: Arms and Equipment Guide (page 94)

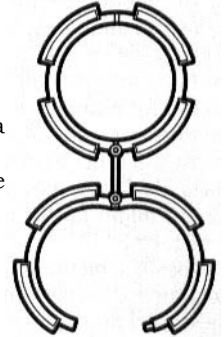

Magnacuffs



Model: Loris Syndicated Securities MCI-100
Type: Personal restraint device
Cost: 75
Availability: 2, F
Game Notes: Magnacuffs have a *Strength* of 6D+2 to hold individuals.
Source: Galaxy Guide 10: Bounty Hunters (page 89), Gundark's Fantastic Technology (pages 70-71), Arms and Equipment Guide (page 94)

Magnaharness

Model: Loris Syndicated Securities MCI-200

Type: personal full-sized restraint device

Cost: 200

Availability: 2, F

Game Notes: Magnaharness have a *Strength* of 8D to hold individuals.

Source: Galaxy Guide 10: Bounty Hunters (pages 89-90), Gundark's Fantastic Technology (page 71)

Biodegradable Binders

Model: TaggeCo.

Biodegradable Binders

Type: Temporary binders

Cost: 75

Availability: 2, R

Game Notes: Once applied, a character must make an opposed *Strength* roll to break free (the binders have a *Strength* of 6D). Once activated, the binders deteriorate in 36 hours. An application of a special harmless molecular solvent will degrade the binders sooner if necessary.

Source: Gundark's Fantastic Technology (page 70), Han Solo and the Corporate Sector Sourcebook (page 117)

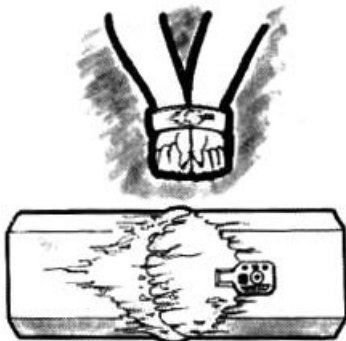

Stun Cuffs

Model: BlasTech AR-101 Stun Cuffs

Type: Stun binders

Cost: 100

Availability: 2, F

Game Notes: The stun cuffs are passive if the cuffed character does not struggle. If the character does struggle, the cuffs do stun damage equal to the character's *Strength*.

Source: The Jedi Academy Sourcebook (pages 140-141), Gundark's Fantastic Technology (page 73)

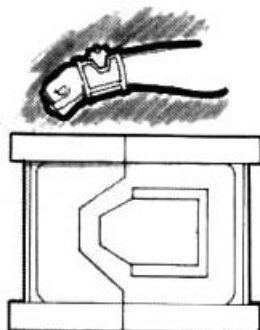

SC-401 Stun Cuffs/Remote

Model: Loris Syndicated Securities SC-401 Stun Cuffs/ Stun Cuff Remote

Type: Stun binders

Cost: 100 (remote: 500)

Availability: 4

Game Notes: The stun cuffs are passive if the cuffed character does not struggle. If the character does struggle, the cuffs tighten causing physical pain (2D damage). The tightening feature can be deactivated with a Very Difficult *security* roll, but if the roll fails by 10 or more, the cuff tightens, dealing damage. Deciphering the seven-digit master code requires a Heroic *computer programming/repair* roll, failure by 10 or more causes the cuffs to tighten. The restraint can be controlled by a remote control that lock, unlocks and activates a stun charge that deals 5D

stun damage. Remote has a 50-meter range and can control multiple stun cuffs.

Source: Arms and Equipment Guide (page 94)

Yuuzhan Vong Cuffs

Model: Yuuzhan Vong Cuffs

Type: Organic restraint device

Scale: Character

Cost: Not available for sale

Availability: 4, X

Game Notes: These small creatures are used by the Yuuzhan Vong as restraint devices, and are locked around humanoid wrists much like regular handcuffs or binders. Anyone attempting to escape can roll a *security* skill check, with a Heroic +15 difficulty. On a failed roll, the cuffs tighten painfully, inflicting 1D of damage. If attacked, the creature has a Body *Strength* of 2D, and an armor bonus of +3D. If not killed in a single attack, the creature will tighten its grip, inflicting 2D damage per round until dead.

Source: The New Jedi Order Sourcebook (page 103)

Security Collar

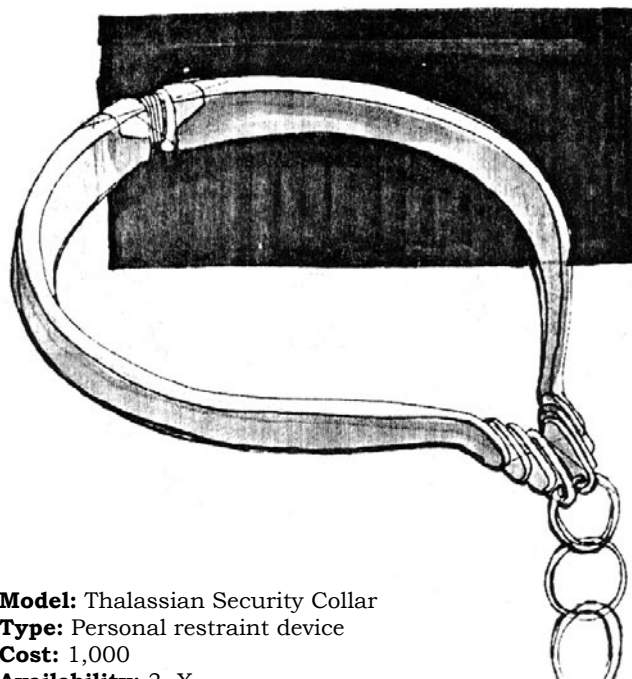

Model: Thalassian Security Collar

Type: Personal restraint device

Cost: 1,000

Availability: 3, X

Game Notes: Security collars have a *Strength* of 7D+1 to hold individuals. If the collar takes any damage, or if a *security* attempt to escape (Heroic+10 difficulty) fails by more than 5, it delivers an extremely painful neural shock, (2D damage, victim must make a Difficult *stamina* roll or fall unconscious). Most security collars come with remote triggers or voice activation.

Source: Arms and Equipment Guide (pages 94-95)

Neural Control Collar

Model: Cybersoft Corp. neural Control Collar

Type: Animal control device

Cost: 600 (one collar and basic control computer), 300 (collar only), 1,000 (control computer for use with multiple collars)

Availability: 2, R or X

Game Notes: Causes 7D stun damage, but instead of falling unconscious, the animal is subjugated by the control computer, capable of giving simple instructions. A central computer can control up to 50 collars with a range of 5 kilometers. A collar that is moved out of range of its control unit will automatically make its wearer return to the control unit and inflict 6D damage.

Source: Galladinium's Fantastic Technology (page 58)



Slave Collar (and Director Unit)

Model: Custom-made Slave Collars with Director Unit

Type: Slave collars

Scale: Character

Cost: 10,000 (for one director unit and 10 slave collars)

Availability: 3, R or X

Game Notes: 2D-5D physical damage depending on setting, "kill" setting: 8D damage.

Source: Gundark's Fantastic Technology (page 72), Han Solo and the Corporate Sector Sourcebook (page 121)

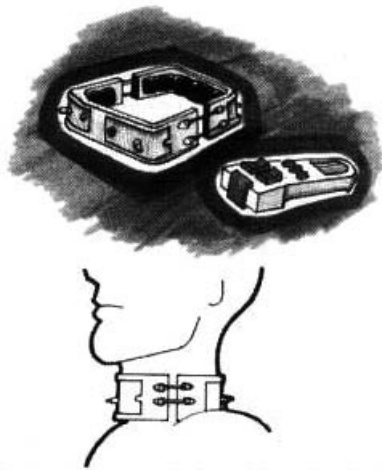

Electro-Collar

Type: Personal restraint device

Cost: 1,000

Availability: 3, X

Game Notes: Security collars have a *Strength* of 8D to hold individuals. They can be remotely triggered to explode, doing 10D damage.

Source: Geonosis and the Outer Rim Worlds (page 14)

Bio-Cocoon

Model: Dendratis Biological Exports, Incorporated Bio-Cocoon

Type: Biological containment system

Cost: 2,000

Availability: 3

Game Notes: Upon activation, the intended victim must make a Moderate *brawling parry* roll to avoid entrapment (for victims up to 150 kilograms; victims from 151-300 kilograms need only make an Easy roll, while 301-450 kilograms targets require a Very Easy roll; this unit has no effect on targets over 450 kilograms). Failure results in an immediate -1D to *Dexterity* and 1D stun damage. Increase

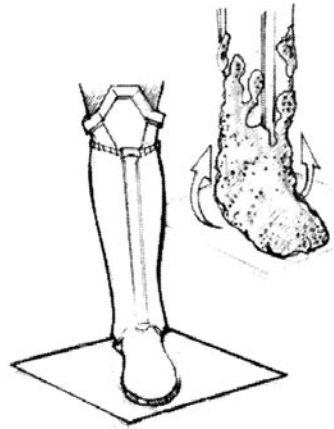

the *brawling parry* difficulty to escape by one level each additional round and increase the *Dexterity* penalty by -1D and increase the stun damage by +1D. The target is fully cocooned when the *Dexterity* penalty matches or exceeds the character's *Dexterity* or the stun damage is sufficient to knock out the character.

Source: Galladinium's Fantastic Technology (page 53)

Man Trap

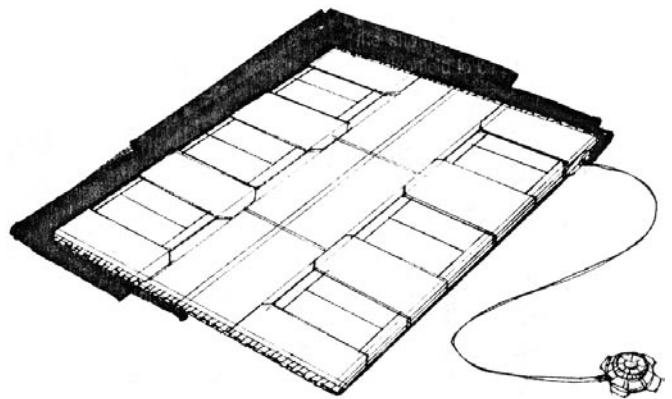

Model: Ubrikkian R-TechApp Man Trap

Type: Localized gravity enhancer

Cost: 8,000

Availability: 3, F

Game Notes: The person setting the man trap should make a *hide* roll to see how well the device is hidden; any potential target making a successful *Perception* roll will notice the trap. Anyone caught by the trap must make an opposed *Strength* roll – the man trap's gravity setting is variable, simulated by allowing the hunter to choose a *Strength* anywhere between 5D and 15D.

Source: Galaxy Guide 10: Bounty Hunters (page 90), Gundark's Fantastic Technology (page 71)

Restraint Capsule

Model: Damorind Securities RPC-12

Type: Shipboard containment system

Skill: Security

Cost: 10,700

Availability: 3, F

Game Notes: The shock system may be set for variable damage (1D-7D, stun or normal damage). Anyone confined within the cage must make an opposed roll against the cage's *Strength* of 7D to break out.

Source: Galaxy Guide 10: Bounty Hunters (page 90), Gundark's Fantastic Technology (pages 71-72)

Force Cage

Model: Damorind Securities Model S-3

Type: Humanoid portable containment system

Skill: Security (to assemble)
Cost: 7,000

Availability: 3

Game Notes: As Easy *security* roll is necessary to properly assemble the device; if not assembled properly, the shock system does not work. The shock system may be set for variable damage (1D-7D, stun or normal damage). Anyone confined within the cage must make an opposed roll against the cage's *Strength* of 7D to break out.

Source: Galaxy Guide 10: Bounty Hunters (page 89), Gundark's Fantastic Technology (page 70)



Universal Energy Cage

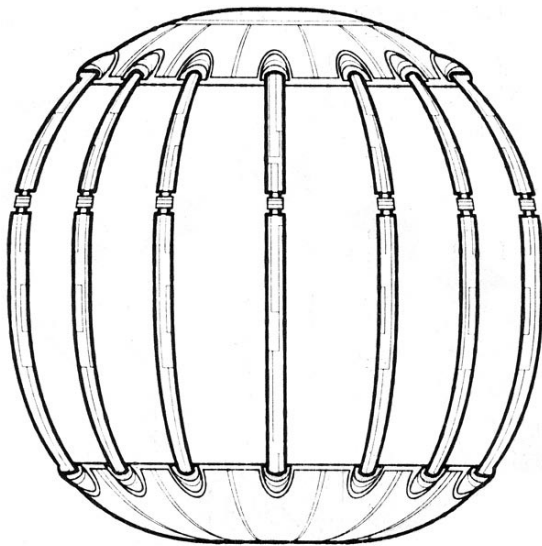

Model: Imperial Universal Energy Cage

Type: Enclosed prisoner transfer system

Scale: Character

Cost: 100,000

Availability: X (restricted to legal governments)

Move: 15; 45 kmh

Game Notes: Energy cage encloses prisoner in a force field with a *Strength* of up to 15D (unit only applies as much energy as necessary to restrain prisoner, so the energy level is often much tower when not being resisted). Somehow, the cage emanates a special type of energy that blocks Force energies and similar mental energies with an effectiveness of up to 15D. The unit has a special repulsor unit keeping the prisoner suspended in the center of the cage. This bottom mounted unit also supplies oxygen to the prisoner (there are no provisions for food and water; it is presumed that a Jedi will go into hibernation if he or she spends a long time in the cage).

Source: Dark Empire Sourcebook (page 129), Gundark's Fantastic Technology (page 74)

Anti-Security

Code Slicer

Model: Duwani Mechanical Products UniSlice

Type: Security code breaker

Skill: Security

Cost: 2,000

Availability: 3

Game Notes: Provides +1D *security* bonus in attempts to bypass or break through security measures.

Source: Gundark's Fantastic Technology (page 96), Tales of the Jedi Companion (page 122)

Security Kit

Type: Typical security kit

Skill: Security

Cost: 750, 1,500 (mastercraft)

Availability: 2, R or X

Game Notes: A security kit is a set of special tools for bypassing electronic and mechanical locks. This item gives it user a +1D bonus on *security* rolls. It also provides a +1D bonus on any repair rolls relating to security systems.

A mastercraft security kit provides a +2D bonus and

contains a comlink that monitors frequencies typically used by silent alarms, so the user can know if such an alarm has been triggered at any point during the operation.

Source: d20 Core Rulebook (page 143)

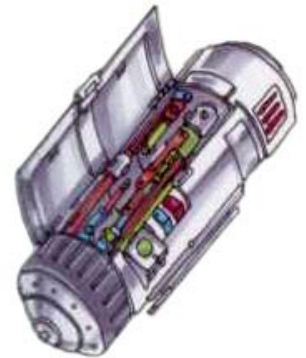

Lock Breaking Kit

Model: Individual manufacture; many types

Type: Security code de-scrambler

Skill: Security: lockpicking

Cost: 8,000 (if purchased through legitimate agent), 16,000+ (black market price)

Availability: 4, R or X

Game Notes: Adds +2D to a user's *security* skill when attempting to open an electronically sealed entryway.

Source: Pirates & Privateers (page 49), Rules of Engagement – The Rebel SpecForce Handbook (page 45)

Electronic Lock Breaker

Model: Outlaw Tech Lock Breaker

Type: Security tampering unit

Skill: Security, computer programming/repair

Cost: 25,000 (basic unit), 1,000 (per security system profile software package)

Availability: X*

Game Notes: The Lock Breaker requires a Moderate *security* roll to activate and a Difficult *computer programming/repair* roll to successfully determine gene code sequences in advanced computer locks. Specific system profiles must be programmed before use, but pre-programmed system profiles (which are quicker to enter and generally more effective than "homemade" profiles) can be installed with a Moderate *computer programming/repair* roll.

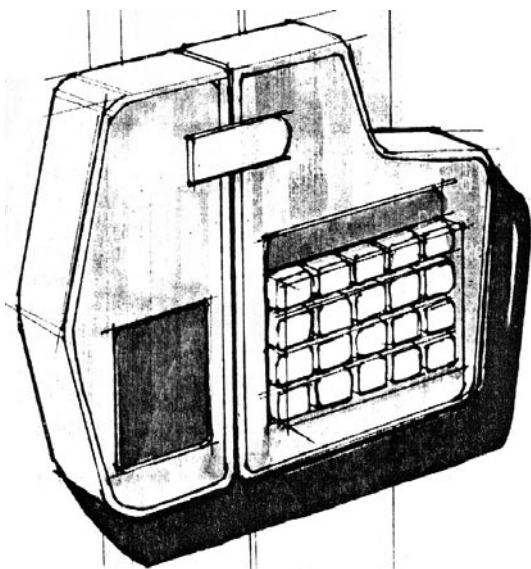

* **Note:** This item is not available prior to the Battle of Endor.

Source: The Last Command Sourcebook (pages 122-123), Gundark's Fantastic Technology (pages 97-98), The Thrawn Trilogy Sourcebook (pages 188-189)

Master Coder Chip

Type: Illegal security override

Skill: Security

Cost: 1,000 - 340,000 (dependant upon quality and utility)

Availability: 4, X

Game Notes: A properly coded master coder chip gives the user a +1 to +4D bonus to *security* rolls involving electronic systems (electronic code locks, palm print scanners and retinal scanners, for example; the bonus modifier depends upon the sophistication of the computer system) but failure on a *security* roll (or a "1" on the Wild Die roll) means that the illegal master coder has been detected by the security system, sounding an alarm.

Source: Gundark's Fantastic Technology (pages 98-99), The Truce at Bakura Sourcebook (pages 138-139)

VoiceBox

Model: BothiCorp VoiceBox Speech Patter Duplicator

Type: Voice lock buster

Skill: Security

Cost: 5,000

Availability: X

Game Notes: A successful *security* roll against the lock's difficulty rating is required for success.

Source: Gundark's Fantastic Technology (page 99)

Retinal Disguiser

Model: Individual criminal manufacture

Type: Retinal pattern falsification device

Skill: Medicine

Cost: 25,000 (black market)

Availability: 4, X

Game Notes: Normal operation requires an Easy *medicine* total. In the event that a pre-existing pattern has been loaded into the device (rather than storing a live subject scan), the gamemaster must determine the relative accuracy

of the pattern. This may require the user to make a higher difficulty roll. Users deemed to be sufficiently proficient may attempt to manufacture their own retinal patterns "from scratch". Such attempts will always result, however, in much higher *medicine* difficulties.

Source: Galaxy Guide 11: Criminal Organizations (pages 84-85), Gundark's Fantastic Technology (page 110)



Fingerprint Masque

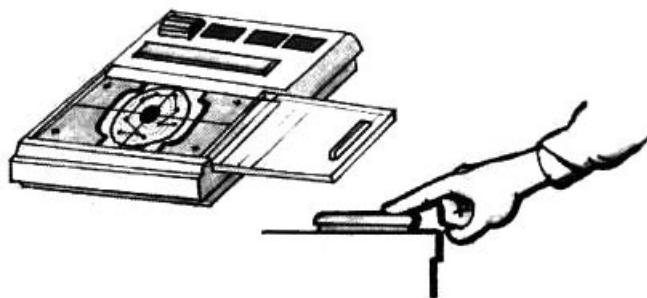

Model: Individual criminal manufacture

Type: Fingerprint pattern alteration kit

Skill: Computer programming/repair (to use)

Cost: 15,000 (black market)

Availability: 4, X

Game Notes: The flip-top surface contains a liquid crystal display used to confirm commands and the display of desired patterns. The bottom half of the device's "pad" contains a small input panel and a "sensor pad" where the digit is placed while the new pattern is being formed.

Source: Galaxy Guide 11: Criminal Organizations (page 84), Gundark's Fantastic Technology (page 108)

Shipjacking Kit

Model: Individual manufacture

Type: Ship security code scrambler

Skill: Security

Cost: 8,000 (licensed collection agency), 16,000+ (black market)

Availability: 4, F or X

Game Notes: Adds +3D to user's *security* roll to break through a ship's security code system.

Source: Galaxy Guide 11: Criminal Organizations (pages 85-86), Gundark's Fantastic Technology (page 99), Han Solo and the Corporate Sector Sourcebook (page 121)

Tri-laser Engraver

Model: Opirus Personal Lasers, Model KL-543
Type: Tri-laser engraver
Skill: Forgery
Cost: 4,000; 8,000+ on the black market
Availability: 3, F or R
Game Notes: Long-term close-up use of this device without proper protective eyewear can lead to temporary visual distress and permanent injury.
Source: Galaxy Guide 11: Criminal Organizations (page 86), Gundark's Fantastic Technology (page 110)

Disguises

Disguise Kit

Type: Typical disguise kit
Skill: Con: disguise
Cost: 500
Availability: 2, R
Game Notes: This kit contains an easily hidden voice-distorter, prosthetics, pigments, and contact lenses. It allows humanoids to pass for a member of some other humanoid species of similar size, adding a +1D bonus to any *con: disguise* skill rolls.
Source: Coruscant and the Core Worlds (page 125), Ultimate Adversaries (pages 155-156)

Flesh Camouflage

Model: Illicit Electronics Flesh Camouflage
Type: Personal disguise device
Skill: Computer programming/repair
Cost: 11,000 (computer), 500 (per retinal contact pair; non-reusable), 500 (per SecCard taker), 250 (per flesh concealment kit, non-reusable)
Availability: 4, X
Game Notes: The operator must make a *computer programming/repair* roll:

Roll	Result
Very Easy	Contacts, SecCard and flesh are all unusable
Easy	Contacts: +2 to <i>security</i> for retinal scans SecCard: +2 to <i>security</i> for card scans Flesh: +2 to <i>con</i> .
Moderate	Contacts: +1D to <i>security</i> for retinal scans SecCard: +1D to <i>security</i> for card scans Flesh: +1D to <i>con</i> .
Difficult	Contacts: +1D+2 to <i>security</i> for retinal scans SecCard: +1D+2 to <i>security</i> for card scans Flesh: +1D+2 to <i>con</i> .
Very Difficult	Contacts: +2D to <i>security</i> for retinal scans SecCard: +2D to <i>security</i> for card scans Flesh: +2D to <i>con</i> .
Heroic	Contacts: +3D to <i>security</i> for retinal scans SecCard: +3D to <i>security</i> for card scans Flesh: +3D to <i>con</i> .

Retinal Contact: These will produce thin plasticized membranes which replicate the retina pattern of the target to be impersonated.

Chemical Security Card (SecCard): This will store 10 image sheets, which can contain pictures, text information or

identification with proper code sequences. The SecCard has no electronic parts. O change to the next identification screen, one presses the "advance" button. Once an image sheet is used the information cannot be retrieved.

Flesh Disguise: These are replicas of the face, hands, and feet of another person. Once fitted into place, the replications are extremely effective at a distance. The mouth of the disguise has a small electronic link to modify the pitch and tone of the voice (if the recorded voice is available)

Source: Galladinium's Fantastic Technology (pages 95-96)

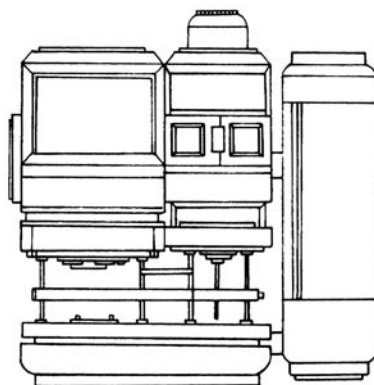

Ooglyth Masquer

Model: Yuuzhan Vong Ooglyth Masquer
Type: Organic disguise
Scale: Character
Skill: Con: disguise
Cost: Not available for sale
Availability: 4, X
Game Notes: The ooglyth masquer, similar to the ooglyth cloaker, covers its user's body with a convincing disguise. Each masquer is engineered to mimic a specific species. When used, an ooglyth masquer grants a Yuuzhan Vong a +3D bonus to his *con: disguise* skill roll. Just like the ooglyth cloaker, the masquer is painful to wear, and inflicts 2D damage every time it is worn. It can also be removed by pressing a hidden organ.
Source: d20 Core Rulebook (page 356), The New Jedi Order Sourcebook (page 23)

Shadowcloak

Model: Shadowcloak
Type: Disguise field
Scale: Character
Skill: Con: disguise
Cost: 10,000
Availability: 3, R
Game Notes: This device, when worn, distorts the wearer's voice until it cannot be recognized, even to a voice reader. It also creates a static "black field," which generates a field of blackness over the wearer's entire body. This makes the subject featureless to all eyes and sensors. A shadowcloak grants a +6D bonus to any *con: disguise* skill checks made to conceal a character's identity. An opposed *search* roll can be attempted against the wearer's *con: disguise* skill if an observer wishes to identify the subject. The downside is that a subject cannot walk around without being identified, but must instead remain stationary. The device can maintain its black field for an hour, after which it must cool down and recharge for 4 hours.
Source: Coruscant and the Core Worlds (pages 44-45)

DimSim

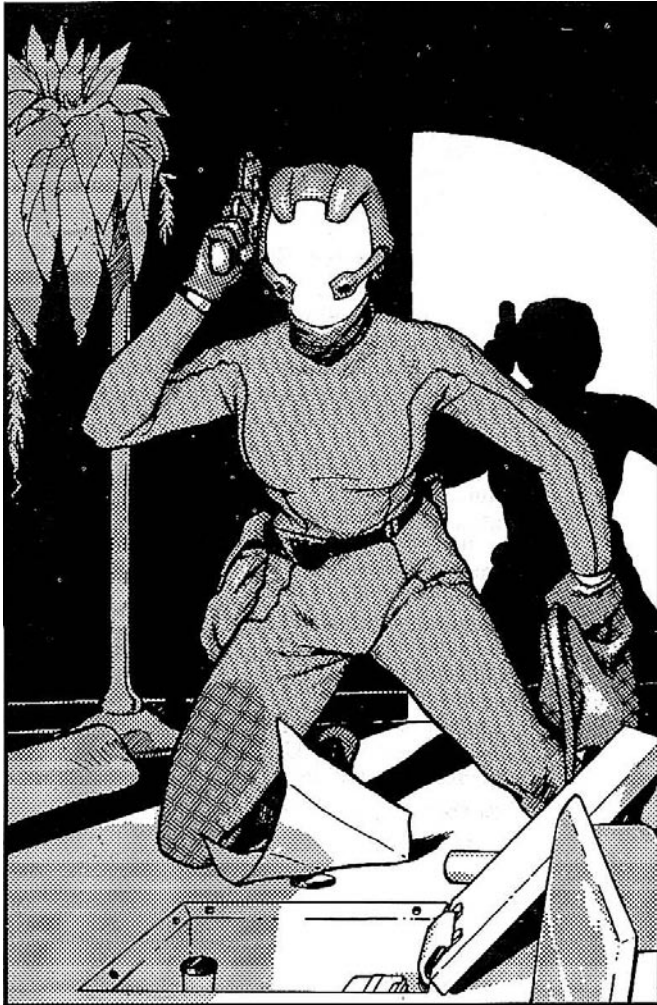

Model: DimSim (custom designed unit)
Type: Personal holographic projector/interference unit
Cost: 5,000
Availability: 4, X
Game Notes: DimSim completely conceals the user's features.
Source: Galaxy Guide 11: Criminal Organizations (page 85), Gundark's Fantastic Technology (page 107)

Holographic Image Disguiser

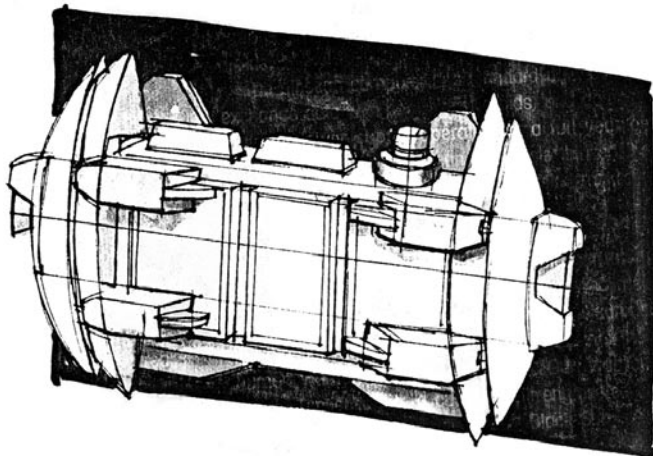

Model: Corellidyne CQ-3.9x
Type: Holographic image disguiser
Cost: 25,000
Availability: 4

Game Notes: This small unit can be worn on a belt and projects an holographic image over an existing real world object or living creature. Its memory capacity can store only a single holographic image and it can operate for 2 minutes before recharging, though it's possible to hook it up to a larger power supply. The holoprojection is almost perfect and even moves as the item or person shrouded moves. It takes a Difficult *search* roll to detect a fake, though sensors, cameras and droids get a +2D bonus to detect it.
Source: Arms and Equipment Guide (page 91), Ultimate Adversaries (page 155)

Doubler Suit

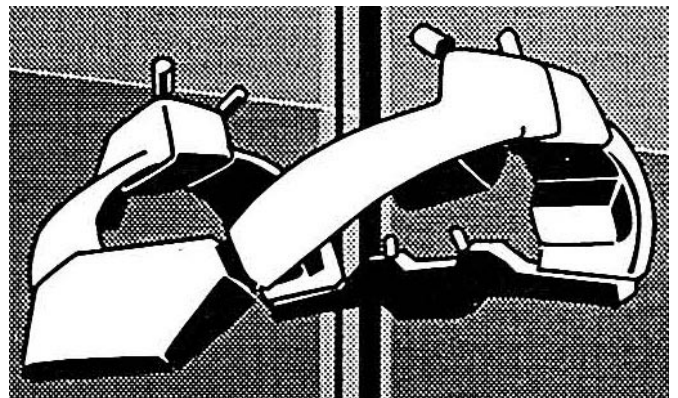

Model: Modified Corellidyne Holographic Projector Doubler Suit
Type: Human-sized three-dimensional imaging system
Skill: Computer programming/repair (Difficult difficulty to properly operate doubler imaging application; if the *programming* roll fails, the flaws will be immediately evident the first time the doubler image is used)
Cost: 30,000
Availability: 4, X

Game Notes: Once programmed, an Easy *Mechanical* roll will allow projection of lifelike image duplicating the character. The image can be projected in any direction, up to 10 meters away. The operating character should secretly inform the gamemaster of attempts to project the holo image, specifying location and distance relative to the true individual. If a successful roll is made, all others will see the apparent image of original character projected as previously indicated. Viewers must make Very Difficult *Perception* or *search* roll to discover the true nature of the image (at a range of 50 meters or more; for every 10 meters close to the target, reduce the difficulty by one level).

Source: Galaxy Guide 10: Bounty Hunters (page 88), Gundark's Fantastic Technology (page 52)

Droid Gear

Fine Work Grasper Arm

Model: Varies widely
Type: Droid appendage
Scale: Character
Skill: Lifting
Cost: 350 credits
Availability: 2

Game Notes: Fine work grasper arms are retractable, folding into a small compartment in the droid's chassis. The arm extends up to 0.5 meters and has servo-boosted mechanisms in the joints and "fingers" (which allow the droid to type or manipulate small objects). There are a number of types available, some tipped with claws or pincers, others with three- or five-fingered "hands."
Source: Cynabar's Fantastic Technology (page 34)

Heavy Grasper Arm

Model: Varies widely
Type: Droid appendage
Scale: Character
Skill: Lifting
Cost: 550 credits
Availability: 2

Game Notes: Heavy grasper arms are retractable, folding into a small compartment in the droid's chassis. The arm extends up to 0.5 meters and has servo-boosted mechanisms in the joints and "fingers" (which allow the droid to type or manipulate small objects and add +2D to *lifting* attempts). There are a number of types available, some tipped with claws or pincers, others with three- or five-fingered "hands."
Source: Cynabar's Fantastic Technology (page 34)

Cargo Winch

Model: Utilitech AR5G Cargo Winch
Type: Small cargo-lifting device
Scale: Character
Skill: Lifting
Cost: 400 (for basic unit), 800 (for heavy lifting winch)
Availability: 2

Game Notes: A cargo winch typically comes equipped with 50 meters of durasteel cable, and is capable of supporting 80 kilograms (though the droid must anchor itself; factors such as unstable or uneven ground can increase the *lifting* difficulty by one level). A heavy cargo winch is also available;

it performs much like a standard winch but gives the droid +1D to *lifting* attempts.

Source: Cynabar's Fantastic Technology (pages 33-34)

Line Caster

Model: Jabriel VCA Droid Line Caster
Type: Cable delivery system
Scale: Character
Skill: Blaster: line caster (or Dexterity) Cost: 1,100 credits
Availability: 2, F

Game Notes: The line caster can fire a grappling hook and cable up to 50 meters (1-10/20/50) though some type of targeting SkillWare is needed to use the device effectively.

Source: Cynabar's Fantastic Technology (page 36)

Digging Claws

Type: Droid digging claws
Skill: Strength: digging
Cost: 500
Availability: 2

Game Notes: A droid with digging claws gains a burrow speed equal to one-half its Move (rounded down). It can move at full burrow speed through solid stone and at half this rate through transparisteel.

Source: Ultimate Adversaries (page 156)

Circular Saw

Model: Industrial Automaton Type 10 Cutting Saw
Type: Circular saw
Scale: Character
Skill: Any appropriate repair skill; use *melee combat: circular saw* in combat
Cost: 500 (for external model), 1,200 (for retractable internal model; droid must be a minimum of 0.3 meters long/tall)
Availability: 2

Game Notes: The type 10 cutting saw does 4D damage and has a range of 0.3 meters. It can be used in combat, though the device's limited range and damage make it an impractical weapon at best.

Source: Cynabar's Fantastic Technology (page 34)

Welding Laser

Model: Drever Corporation HLAutomata-Assisted Welding Laser

Type: Welding tool

Scale: Character

Skill: Any appropriate repair skill; use *blaster: welding laser* in combat

Cost: 1,200 credits

Availability: 2

Game Notes: The HL welding laser is a small, versatile tool designed for ship-based repair efforts. The laser is small (5 cm long), attached to an external blaster power cell that can be strapped to a droid. The laser has a short range (3 centimeters) but is extremely powerful (5D+2 damage); the welding beam lasts for 10 rounds. If there is no power cell available, the laser can be powered for short periods of time by the droid's own energy source; such a hook-up requires 1D rounds and a Moderate *droid* repair roll. The beam will last for 5 rounds if powered by the droid. If the droid attempts to run the beam for longer periods of time, it must make a Moderate *stamina* or *Strength* roll (whichever is higher); if the droid fails the roll, it takes 2D damage each round until the beam is deactivated. (Regardless, the beam will only last for a maximum of 10 rounds.)

Source: Cynabar's Fantastic Technology: Droids (page 38)

Stun Field

Type: Droid stun field

Scale: Character

Cost: 750

Availability: 2, R

Game Notes: A stun field is built into a droid's exterior to deliver a painful shock to any creatures touching the droid. Anyone touching the droid (including melee weapon attacks) when the field is active takes 4D stun damage. A stun field emits a constant humming noise while active, granting a +2 bonus to *search* rolls to notice the droid.

Source: Ultimate Adversaries (page 156)

Storage Compartment

Model: Utilitech Droid Storage Module

Type: Storage compartment

Scale: Character

Cost: 200 credits (external compartment), 4,000 (internal compartment)

Availability: 2

Game Notes: Utilitech storage compartments can hold small amounts of "cargo." External "storage packs" are generally magnetically sealed to a droid, and require a Difficult *droid repair* roll to remove. These packs are small (20 centimeters long, 10 centimeters, 8 centimeters deep) and can hold objects (such as a comlink, small blaster, datapad or medpac) that an owner may wish to retrieve later. External compartments are immediately visible; internal compartments can be detected with a Moderate *search* or *Perception* roll (or an Easy *sensors* roll). Most droids of moderate size (1 meter or taller) can be equipped with a maximum of two compartments; smaller droids can be equipped with a single compartment (Utilitech custom-manufactures smaller compartments for the price of an internal compartment).

Source: Cynabar's Fantastic Technology: Droids (page 38)

Sensor-Shielded Storage Compartment

Model: Illegally-modified Utilitech Droid Storage Module

Type: Sensor-shielded storage compartment

Scale: Character

Cost: 500 credits (external compartment), 8,000 (internal compartment)

Availability: 3, X

Game Notes: Utilitech storage compartments can hold small amounts of "cargo." External "storage packs" are generally magnetically sealed to a droid, and require a Difficult *droid repair* roll to remove. These packs are small (20 centimeters long, 10 centimeters, 8 centimeters deep) and can hold objects (such as a comlink, small blaster, datapad or medpac) that an owner may wish to retrieve later. External compartments are immediately visible but sensor-absorbent material makes it virtually impossible to detect what is inside (requires a Very Difficult *sensors* roll). Internal compartments can be detected with a Very Difficult *search* or *Perception* roll (or a Difficult *sensors* roll). Most droids of moderate size (1 meter or taller) can be equipped with a maximum of two compartments).

Source: Cynabar's Fantastic Technology: Droids (page 37)

Internal Comlink

Model: Fabritech "VoxLink" Internal Comlink

Type: Basic droid internal comlink

Scale: Character

Skill: Communications

Cost: 100

Availability: 2

Game Notes: The VoxLink has a broadcast and reception range of 50 kilometers in clear weather. It can monitor up to 10 frequencies simultaneously.

Source: Cynabar's Fantastic Technology (page 36)

Subspace Tight-Beam Transmission Core

Model: MerenData 45-T InfoCore

Type: Subspace tight-beam transmission core

Cost: 900 credits

Availability: 2, R

Game Notes: The subspace transmission core is one of the integral portions of an espionage unit's secondary programming, for it relays the information to its planter. Upon receipt of a prearranged high-frequency signal, the droid downloads the information via the tight beam to the signal's source. It takes a Very Difficult *droid programming* roll to detect an espionage droid, and the programmer must specifically state that he or she is searching for the secondary programming. Once the secondary programming is detected, it requires a Moderate *droid programming* roll to remove the chips without damaging the droid. The chips must be physically removed, as the espionage programming will withstand a normal memory wipe.

Source: Adventure Journal 10 (page 140)

Astromech Voice Box

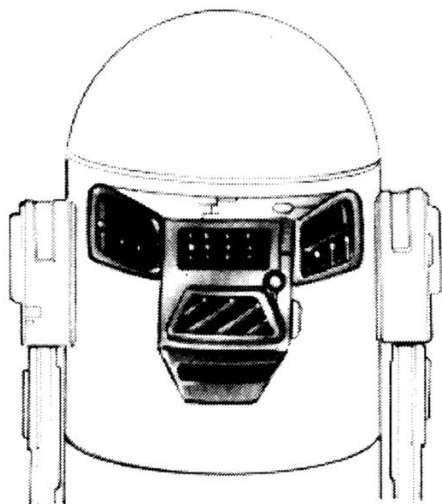

Model: Industrial Automaton R-Series Voice Box Adaptor

Type: Astromech verbal attachment

Cost: 250

Game Notes: Allows an R-series droid to speak a specific language (language programs run from 25 to 100 credits), with adjustable pitch, intonation and accent. Installation requires a Moderate *droid repair* roll and takes 15 minutes. Removal requires an Easy *droid repair* roll and 15 minutes; failure causes 3D stun damage to the droid and randomly eliminates one skill.

Source: Galladinium's Fantastic Technology (page 27)

Modified Tranlang III Module

Model: TranLang III communication module (modified)

Type: Modified droid and systems organic and electronic translation module

Cost: 1,500 credits (market version)

Availability: 2 (market version), modified Alliance Intel version is strictly illegal

Game Notes: The modified unit uses pre-specified keywords in a specific language understood by the receiving agent (usually organic), so that any translator droid or opposed agent monitoring communications takes the exchange as simple conversation. The modification of a standard unit to the specifications above requires a Difficult *droid programming* roll, followed by a Moderate *droid repair* roll to install the unit without damaging the droid. Planting the droid in the desired locale afterwards is another matter.

Source: Adventure Journal 10 (page 139)

Holocam

Model: Neuro-Saav TL3 Holo-Imaging Package

Type: Droid recording device

Scale: Character

Skill: Sensors

Cost: 2,500 (basic unit)

Availability: 2

Game Notes: The TL3 holocam is designed specifically for droids; it is a small processing device that can be tied into the droid's existing optical modules, allowing a complete first person view from the droid's perspective (up to 20 meters, limited by droid's line-of-sight). Images can be downloaded to datacards, dataplaques or holoprojectors,

allowing playback and storage of the recording. The basic TL3 ties into the droid's existing optics, though only human-range recordings are possible. For an additional 200 credits per upgrade, the TL3 can be adapted to record with the following improvements: macrobinocular hookup (improves range of recording to 100 meters), all-environment (360 degree recording, in a 10-meter radius; playback appears as if the viewer is "with" the droid and can look in any direction to see what else is nearby), thermal, motion sensor, and UV hookup (records in "night-vision" mode with thermal/UV hookups; focuses on moving objects with motion sensor option).

Source: Cynabar's Fantastic Technology (pages 34/36)

Holoprojector



Model: SoroSuub G-series Holoprojection Unit

Type: Holoprojector

Scale: Character

Skill: Computer programming/repair

Cost: 300-8,000 credits

Availability: 2

Game Notes: Basic holoprojectors-like those that are standard equipment on most R-series astromechs-can project a prerecorded hologram up to 1.5 meters away, with an image size ranging from 0.5 to 10 meters.

Source: Cynabar's Fantastic Technology (page 36)

Intellex IV Internal Computer

Model: Industrial Automation Intellex IV internal computer

Type: Astromech droid internal computer

Cost: 800 credits

Availability: 2

Game Notes: In addition to the ability to scan technical files to pinpoint problems, the Intellex IV also supports sophisticated analysis programs, such as the lifeform identification subroutines (LFIs) and many low level scanner tasks. As the Intellex IV's primary function is to scan technical files and find data patterns, it is very useful to characters who have improved Technical skills and a need to retrieve restricted files and information. A character can use an independent Intellex IV unit as a tool when trying to

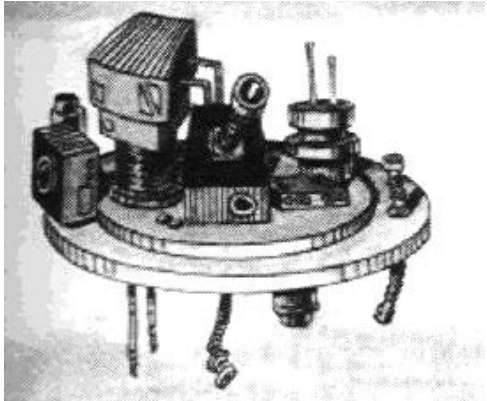

Scomp-Link

Model: Cybot Galactica Nexus Scomp-link

Type: Computer interface

Scale: Character

Skill: Computer programming/repair

Cost: 800

Availability: 2

Game Notes: The scomp-link allows information transfer from a droid to virtually any type of data-storage device (such as a computer, dataplaque or datapad). In addition, the scomplink allows a droid to search computer networks for information (adding +1 D to *computer programming/repair* rolls).

Source: Cynabar's Fantastic Technology: Droids (page 37)

enter restricted systems or files: *computer programming/repair* difficulty numbers should be determined by the gamemaster. If the Intellex IV is part of a non-cooperative astromech droid, a Moderate *droid repair* roll must be made to remove the unit without damage. This procedure usually takes about half an hour to complete. Allied astromech droids, however, are often willing to execute such operations upon their owner's request. If attempting to do this with an Intellex V or VI, raise each difficulty one level.

Source: Adventure Journal 10 (page 141)

Owner Gear

CL-3 Droid Command Link

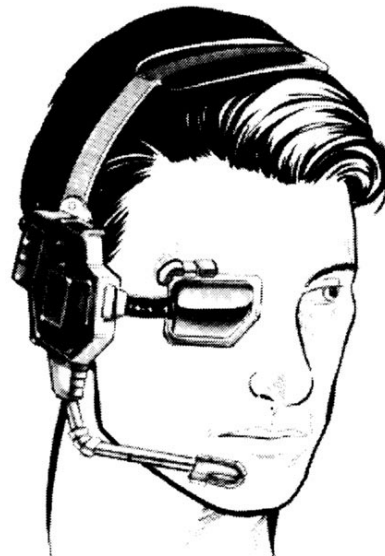

Model: AccuTronics CL-3 Droid Command Link

Type: Remote droid command link

Cost: 850

Game Notes:

Unit contains all the features of a comlink and allows user to command a droid equipped with a response rig from a range of up to one kilometer. Installation requires a Moderate *droid repair* roll, and Easy *droid programming* roll and two hours of work. Unit displays audio/video feed from linked droid's sensors, and allows switching of supported visual ranges (infrared, ultraviolet, etc). Another control allows droid's communications to be displayed as text.

Source: Galladinium's Fantastic Technology (pages 26-27)

Internal Automap

Model: SoroSuub "AutoTracker" Droid GPS Module

Type: Global positioning system

Scale: Character

Cost: 4,000 credits

Skill: Computer programming/repair

Availability: 2

Game Notes: It is virtually impossible for a character using an Automap to get lost. As long as the device is linked to an orbiting source of data (such as a ship's sensors or a weather satellite) the device relays accurate data regarding the user's location, local weather conditions, other moving objects and navigational hazards. The link requires a Moderate *computer programming/repair* roll once per hour to maintain. The droid using the automap link can automatically display this information on a datapad (with a scomp-link) or project it on any on-board imaging systems it possesses.

Source: Cynabar's Fantastic Technology (page 36)

Astrogation Buffer

Model: Cybot Galactica "Lifeline" Astrogation Buffer

Type: Nav data backup system

Scale: Character

Skill: Computer programming/repair

Cost: 1,300

Availability: 2, F

Game Notes: An astrogation buffer can store one set of nav coordinates indefinitely; note that any attempts to load more than one set of coordinates into the buffer will fail, the newest data overwriting the older information. A scomp-link (and a Moderate *computer programming/repair* roll) allows this data to be downloaded into a nav computer, after which the information is deleted.

Source: Cynabar's Fantastic Technology: Droids (page 33)

Cyborg/Droid Interface

Model: Neuro-Saav Cyborg/Droid Interface

Type: Cyborg/droid interface

Cost: Normally included with cyborg construct, 600 if installed separately

Cyber Points: 0

Game Notes: Cyborg/Droid interface makes all *droid*

Droid Customization Kit

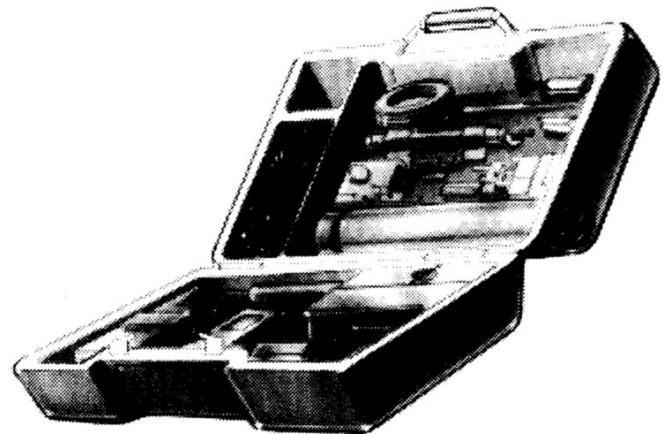

Model: Ulqib MacroTronics Droid Customization Kit

Type: Droid modification tool kit

Skill: Droid programming, droid repair

Cost: 400 (additional costs for specific attachments may also be incurred)

Kit Includes:

- Droid datapad neural pathway linkage
- Memory modulator (allows for skill and/or attachments software programming)
- Memory wipe module (completely erases all non-hardwired memory and related skills)
- Replacement actuators
- Replacement micro-servos
- Additional software node (boosts one specific skill +2D over the attribute *if* the droid's skill is less than 2D over the attribute; has no effect if the droid's skill is 2D or more over the attribute)
- Broadband antenna receiver
- Movement sensor (if the droid has less than 2D in *search* (over the *Perception* attribute), the *search* skill goes to +2D over *Perception* only when searching for moving objects within 100 meters of the droid)
- Repulsorlift motor (also requires *repulsorlift repair* skill to install; has a Move of 13 for droids under 100 kilograms)
- Internal computer interface socket
- Two photoreceptors (moderately above Human range)
- Two audio receptors (normal Human range)
- Vocabulator panel
- Database retrieval system (content files must be loaded after installation as per normal programming rules)
- Remote programming receiver

Game Notes: Most hardware additions also require successful installation of corresponding software programming to properly interface new equipment. Additional tools (e.g. electric arc welder) and other droid parts may be required for certain alterations. The gamemaster must determine specific difficulty levels and time taken.

Source: Galladinium's Fantastic Technology (pages 25-26)

programming rolls one difficulty level easier. Use the *computer programming* difficulties listed on page 63 of the Rulebook if the cyborg is trying to learn something the droid does not want to share, although the difficulty is one level easier. Interface is standard on most cyborg implants.

Source: Cracken's Rebel Field Guide (page 33)

Mk-11 Droid Diagnostic

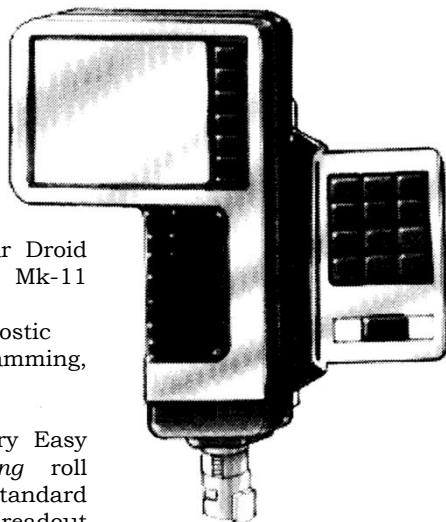

Model: Interstellar Droid Monitoring, Inc. Mk-11 Droid Diagnostic

Type: Droid diagnostic

Skill: Droid programming, droid repair

Cost: 200

Game Notes: Very Easy *droid programming* roll required for standard systems check and readout (takes 30 minutes).

Diagnostic assisted repair procedures normally require an Easy *droid repair* roll and the diagnostic's expertise adds +1D to the skill roll. This bonus is for maintenance only and does not apply to major repairs or modifications.

Source: Galladinium's Fantastic Technology (page 26), Arms and Equipment Guide (page 96)

Restraining Bolt



Skill: Droid repair

Cost: 50 credits

Availability: 1

Game Notes: A droid fitted with a restraining bolt must obey commands sent by a "Caller." The droid cannot resist the effects of the restraining bolt.

Source: Cynabar's Fantastic Technology: Droids (page 40)

Droid Caller

Skill: Droid programming

Cost: 100-500 credits

Availability: 1

Game Notes: A caller is a compact, short-range signaling device that broadcasts directly into a droid's motivational processor (via a restraining bolt). Simple callers can only broadcast simple commands (such as ordering a droid to activate or deactivate). More-sophisticated callers can transmit commands of greater complexity (issuing orders that a droid must obey). The average range of a caller is 20 meters.

Source: Cynabar's Fantastic Technology: Droids (page 40)



Restraining Bolt & Owner

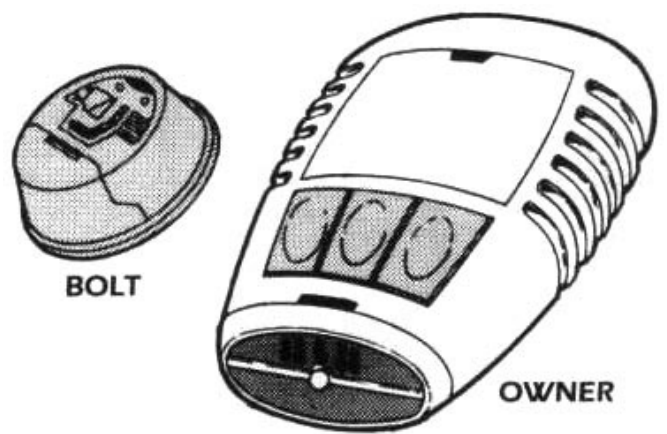

Type: Droid restraining bolt

Scale: Character

Cost: 75

Availability: 1

Range: 50 meters

Game Notes: Retraining bolts have a die code of 3D. Whenever the Droid is commanded to do something, roll 3D against the Droid's *Perception*. If the bolt rolls higher, the droid obeys the bolt. If the Droid rolls higher, the Droid can ignore the restraining bolt.

"Halt" lasts 10 seconds.

"Return" compels the Droid to return.

"Orders" gives pleasure to the Droid so that it will obey its master. If the roll is successful, the Droid will obey the owner regardless of the length of time involved.

Source: Cracken's Rebel Field Guide (page 16)

Ship & Vehicle Equipment

Onboard Computers

Vehicle Remote Activation Controller



Model: Bespin Motors Remote DVI Activator
Type: Remote vehicle controller
Cost: 500 (for speeders); 2,500 (for starfighter scale starships)
Availability: 2
Game Notes: Range is 2 kilometers. Pre-flight checks can take as little as 20 seconds (for some speeders) to well over five minutes (for some starships). The user must still pilot the vehicle manually.
Source: Galladinium's Fantastic Technology (page 18)

Personal Vehicle Coordinator

Model: Vewas Data Controllers PVC-800
Type: Vehicle command controller
Cost: 1,200
Game Notes: Limited vehicles under 10 meters long and under 10 metric tons. Under normal situations, use of this device adds +1D to the appropriate vehicle operation skill. If so programmed by the

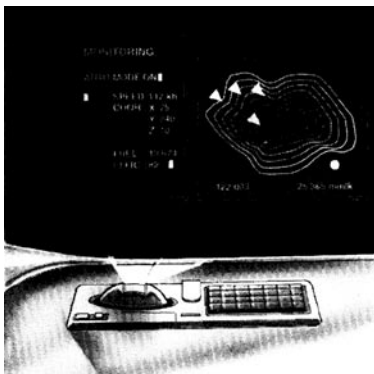

owner, in emergency situations the PVC will automatically make evasive maneuvers to avoid a crash (allows the pilot +2D to his or her operation roll to avoid collision – but the PVC will prevent unsafe maneuvers that Rebels so love to perform).

Source: Galladinium's Fantastic Technology (pages 15/17)

CD-12a Autopilot Droid Brain



Model: Go Corp CD-12a Autopilot Droid Brain

Type: Autopilot droid brain

DEXTERITY 0D

KNOWLEDGE 1D

MECHANICAL 1D

(Has one of the following:) Repulsorlift operation 4D, space transports 4D, starfighter piloting 4D

PERCEPTION 1D

STRENGTH 0D

TECHNICAL 1D

Repulsorlift repair 2D

Cost: 5,000 (repulsorlift), 10,000 (starfighter-scale vehicles)

Availability: 4, R

Game Notes: Wrist activator has a range of up to 5 kilometers.

Source: Galladinium's Fantastic Technology (page 18)

Imperial Neural Interface Device

Model: Imperial Neural Interface Device

Type: Ship neural interface

Cost: 9,000

Availability: X

Game Notes: The neural interface device is wired into the standard control systems of any starship. Four long wires ending in gelatinous diodes are placed on the pilot's temples and just below the ears. After some initialization, the user can issue commands to his ship simply by thought. A character using the interface must make a *Perception* roll every round against the difficulty listed on the chart below. If successful, any rolls made for the ship are made at +2D for that round. This does not count as two actions, as the process is so incredibly fast that it takes practically no time at all.

Ship Type = Difficulty

Small Ship (Lone Scout-A, T-16, etc.) = Easy

Standard Fighter (X-Wing, TIE, etc.) = Moderate

Small Freighter or Bomber = Difficult

Corvettes, Light Cruisers, Frigates = Very Difficult

Cruisers and Star Destroyers = Heroic

Source: Adventure Journal 1 (page 110)

System Diagnostic Filter



Model: GST System Diagnostic Filter

Type: Starship computer translator

Skill: Computer programming/repair, space transports repair

Cost: 3,500

Availability: 2

Game Notes: +1D+1 for *computer programming/repair* for ship board computer systems and +2 to *space transports repair*.

Source: Galladinium's Fantastic Technology (pages 18-19)

Archaic Astrogation Plotter

Model: Republic Siemar Systems A-121 Plotter

Type: Manual astrogation plotter

Cost: 1,000 – 7,500

Availability: 4

Game Notes: If a pilot has all the necessary astrographic information on the point of origin and the destination, using an astrogation plotter to get coordinates quintuples the time a nav computer would ordinarily take; it also increases the *astrogation* difficulty by two levels. Downloading this information into the ship's hyperdrive motivators requires some kind of jury-rigged interface with a personal computer or sophisticated datapad – a Very Difficult *computer programming/repair* roll.

Source: Platt's Smugglers Guide (page 47)

Alliance MasterNav

Model: Alliance MasterNav Software Module Gamma

Type: Specialized navigational database

Skill: Astrogation

Cost: Not available for sale

Availability: 4, X

Game Notes: Alliance MasterNav files can be patched into the navigation system of a starship with an Easy *astrogation* roll, giving a +1D bonus to *astrogation* rolls for one month (assuming the data being downloaded is accurate). However, if the software is older than 1 standard month, the user suffers a -1D penalty to *astrogation* rolls. In addition, a 1 on the Wild Die while using the MasterNav indicates a catastrophic navigational error (roll on the "Astrogation Mishap Table" on the Rulebook).

Source: The Truce at Bakura Sourcebook (page 137)

Nav Computer Bypass

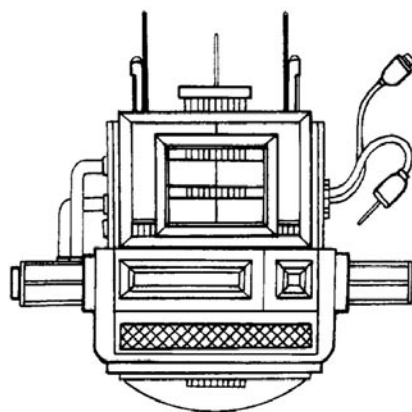

Model: Kuat Drive Yards Computer Route Astrogation Bypass

Type: Prototype navigation computer bypass

Skill: Astrogation

Cost: Not available for sale

Availability: 4, X

Game Notes: Using the Nav-Computer Route Astrogation Bypass (N-CRAB) requires three *astrogation* rolls. The first is programming into the N-CRAB a duplicate of the original course (one difficulty level lower than the original course difficulty). The second roll is to chart a course from an upcoming point in the course to the new destination (the difficulty can vary dramatically, from Very Easy to Heroic). The final roll is to properly feed the course through the N-CRAB into the nav computer (this roll is one difficulty level lower than the second roll). Missing the first or second roll simply means that the N-CRAB will not function. Failing the third roll by any amount causes a mishap as described in the Rulebook. The whole programming procedure takes one-tenth the time of the new hyperspace travel route. Unfortunately, the N-CRAB has a tendency to interfere with a ship's nav computer. The nav computer must be "cleaned" via programming (a Moderate *astrogation* or *computer programming/repair* roll). For a second use of the N-CRAB without cleaning, *all astrogation* difficulties are one difficulty higher. For the third use, all difficulties are two levels higher. Additional uses incur higher penalties (difficulties above Heroic are rated as Heroic+10, Heroic+20, Heroic+30 and do forth).

Source: Galladinium's Fantastic Technology (pages 93-94)

Sensor Countermeasures

Comm Jammer

Model: IntelStar Silencer Comm Jammer
Type: Communications jammer
Skill: Communications
Cost: 5,000 plus installation costs
Availability: 2, R
Game Notes: While any ship use their communications array to jam, this communications jammer uses a ship's transmitters to flood communications frequencies with static. However, comm. jammers have extremely high power demands and can only be used for short duration; basic jammers can operate for 10 combat rounds before requiring recharging (which takes an additional 10 rounds). In addition, for each fire arc that is being jammed, subtract one round from the operating time (focused jamming subtracts 5 rounds from the overall operating time). A ship being jammed must make an opposed *communications* roll against the jamming ship's communications operator. The jamming ship gains bonus dice to jam, based on how many firing arcs are being jammed:

Fire Arcs Jammed	Communications Bonus
All arcs	-
Three arcs	+1D
Two arcs	+2D
One arc	+3D
Focused jamming	+4D

Source: Pirates & Privateers (page 39)

Sensor Jammer

Model: IntelStar BlindSide Sensor Jammer
Type: Sensor jammer
Skill: Sensors
Cost: 5,000 plus installation costs
Availability: 2, X
Game Notes: Any ship can use their sensor array to jam, this jammer uses a ship's transmitters to flood sensors frequencies with static. A ship being jammed must make an opposed *sensors* roll against the jamming ship's sensor operator. The jamming ship adds its *sensor* dice to the jamming roll, using the standard sensor arcs, in active modes only.

Source: Pirates & Privateers (page 39)

Sensor Jamming Hardware

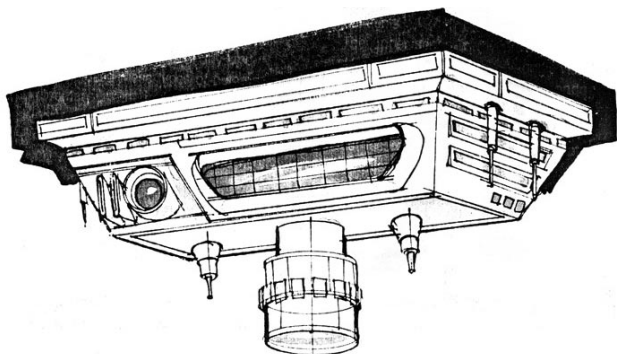

Model: Fabritech NightBlind 472
Type: Sensor jamming device
Cost: 4,000 plus installation costs
Weight: 1 metric ton
Availability: X
Game Notes: +1D to identify, but -2D to detect.
Source: Galaxy Guide 6: Tramp Freighters (page 41)

Sensor Mask

Model: Fabritech Vanish 2 Military Sensor Masking System
Type: Sensor countermeasure masking system
Scale: Starfighter or capital
Cost: 150,000 per Hull die; 300,000 per capital Hull die
Availability: 4, X
Game Notes: When activated, the sensor mask adds 2D to enemy sensor operator's difficulty to detect and identify. Current masking technologies offer a maximum of 3D of sensor protection. Such items are practically impossible to locate, and are often considerably more expensive than the market norm.
Source: Pirates & Privateers (pages 38-39)

Sensor Baffling

Model: Arakyd Nightshadow anti-sensor treatment
Type: Sensor countermeasure coating
Scale: Starfighter or capital
Cost: 20,000 per starfighter scale Hull die (ignore pips); 50,000 per capital scale Hull die (ignore pips)
Availability: 4, X
Game Notes: A ship treated with this material adds to a sensor operator's difficulty to detect the ship. A light treatment adds 1D to the difficulty. A heavy treatment (a second coat) adds 2D. Additional treatments are futile, since the treatment does nothing to prevent the detection of engine exhaust, a primary method of detecting ships. The type of vessel affects how well the ship can be "stealthed" – blunt, angular ships, 500 meters or more in length, or more than 5D Hull (either capital or starfighter scale) can only be "baffled" up to 1D of protection. Slender, rounded off ships (smaller Mon Calamari vessels for example) are easier to baffle, due to their natural design.
Source: Pirates & Privateers (page 38)

"Mimic" Decoy

Model: MerenData Mimic Sensor Decoy
Type: Military sensor countermeasure decoy system
Cost: 13,000 (for two launch tubes and three decoys), 1,000 per decoy
Availability: 2, X
Game Notes: Adds 2D to sensor operator's difficulty to discriminate between the decoy and the real ship. The decoys move up to speed 10, have simple droid brains, and can be issued new movement instructions via comlink or programmed with several patterns. A "false image option" allows the decoy to impersonate any of five preloaded profiles, including the ship of origin, a TIE/ln, a YT-1300 freighter, a *Lambda*-class shuttle or a Corellian corvette. New profiles can be created with a Moderate *droid programming* roll and the appropriate signal profile.
Source: Pirates & Privateers (page 39)

“Trickster” Sensor Decoys

Model: Corellian Engineering Trickster Drone
Type: Sensor countermeasure system
Cost: 7,500 (for launch tube and five drones), 500 per additional drone
Weight: 2 metric tons
Availability: 2, F
Game Notes: Trickster Drones add +2D to difficulty to determine which sensor reading is the ship and which is the decoy. System includes 5 drones. Drones move in a pre-programmed pattern, up to speed 5. Possession of this type of countermeasure requires Imperial certification.
Source: Pirates & Privateers (page 39), Galaxy Guide 6: Tramp Freighters (page 41)

Copycat Pod

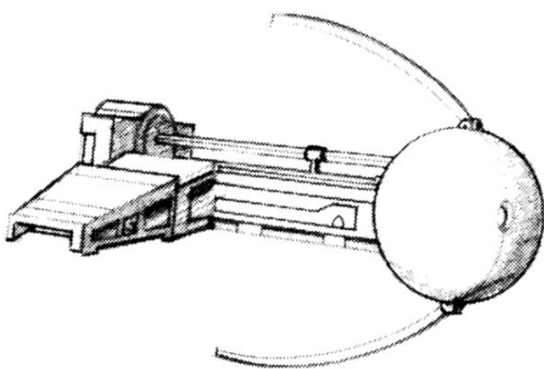

Model: Corellian Engineering Corporation Copycat Pod
Type: Electronic countermeasure probe
Skill: Sensors
Cost: 10,000 (plus permit fees)
Availability: 3, F or R
Game Notes: This device mimics the performance of the parent vessel when used aboard a starfighter or small transport freighter (ship with a cargo hold of 100 metric tons or less); it has a maximum Space speed of 6. Any person attempting to distinguish a copycat pod from a “live” vessel must make a Difficult *sensor* roll on passive or scan mode (Moderate on search mode and Easy on focus mode) to determine which ship is real and which is the decoy. If the roll fails, the sensor operator will perceive both ships as being “real”.
Source: Galladinium’s Fantastic Technology (pages 53-54)

Drives

SoroSuub Boav Ion Drive

Model: SoroSuub Boav Ion Drive
Type: Commercial propulsion system
Cost: 10,000 plus installation costs
Weight: 10 metric tons
Availability: 2
Game Notes: Space rating of 4. Technicians installing a Boav unit will face an increase of one difficulty level in their *space transports repair* roll.
Source: Galaxy Guide 6: Tramp Freighters (page 39)

Incom Starslinger Ion Drive

Model: Incom Starslinger Ion Drive
Type: Commercial propulsion system
Cost: 20,000 plus installation costs
Weight: 12 metric tons
Availability: F
Game Notes: Space rating of 6. Requires a 500 credits Imperial permit. Double all difficulties for modifying this drive and double all modifiers when rolling for mishaps beyond a +1 modification.
Source: Galaxy Guide 6: Tramp Freighters (page 39)

Corellian Evader-GT Ion Drive

Model: Corellian Evader-GT Ion Drive
Type: Commercial propulsion system
Cost: 50,000 plus installation costs
Weight: 16 metric tons
Availability: F
Game Notes: Space rating of 8. Requires a 5,000 credits Imperial permit to legally possess. Double all difficulties for modifying this drive and double all modifiers when rolling for mishaps beyond a +1 modification.
Source: Galaxy Guide 6: Tramp Freighters (page 38)

Boshaa-C’hi Ion Drive

Model: Kuat Drive Yards’ Boshaa-C’hi Ion Drive
Type: Military ion engine
Cost: 100,000 plus installation costs
Weight: 18 metric tons
Availability: X
Game Notes: Space rating of 10
Source: Galaxy Guide 6: Tramp Freighters (page 38)

Starscream-9 Ion Drive

Model: Sienar Fleet Systems’ Starscream-9 Ion Drive
Type: Military ion engine
Cost: 500,000 plus installation costs
Weight: 24 metric tons
Availability: X
Game Notes: Space rating of 12 (atmosphere of 450; 1,300 kmh)
Source: Galaxy Guide 6: Tramp Freighters (page 38)

Baffled Drive

Model: Rendili StarDrive WhisperThrust
Type: Baffled realspace drive
Scale: Starfighter
Cost: 100,000 minimum on the black market
Weight: 20 metric tons; extra tank: 2 metric tons
Availability: 4, X

Game Notes: The Whisper is a highly illegal baffled realspace drive used on stealthy military starships. The Whisper allows a ship to move in space while running silent at a base speed of 2. Cautious movement is no more detectable than drifting; Cruise movement adds +5 to the sensor operator's roll; High Speed adds +10; All-Out movement adds +15. A WhisperThrust engine has a limited storage capacity for the necessary gases to move: enough to move 100 spacial units. An extra or replacement tank costs 7,000 credits. Synthesizing the necessary fuel requires 120 liters of pin-sealed tibanna gas and 2 kilos of high-grade hyperbarides and a standard power generator. The fuel-refining process takes roughly three standard days.
Source: Pirates & Privateers (pages 39-40)

x5 Hyperdrive

Model: Sienar Fleet Systems Lifesaver 1000 Reserve Hyperdrive
Type: Commercial propulsion system
Cost: 2,500 plus installation costs
Weight: 8 metric tons
Availability: 1
Game Notes: The Lifesaver 100 is only recommended as a backup hyperdrive and must be overhauled after *each* use.
Source: Galaxy Guide 6: Tramp Freighters (pages 39-40)

x4 Hyperdrive

Model: Rendili StarDrive's ATX-5
Type: Commercial propulsion system
Cost: 4,000 plus installation costs
Weight: 10 metric tons
Availability: 1
Source: Galaxy Guide 6: Tramp Freighters (page 39)

x3 Hyperdrive

Model: Incom Horizon-Hopper Light Stardrive
Type: Commercial propulsion system
Cost: 7,000 plus installation costs
Weight: 12 metric tons
Availability: 2
Source: Galaxy Guide 6: Tramp Freighters (page 39)

x2 Hyperdrive

Model: Corellian Avatar-10
Type: Commercial propulsion system
Cost: 10,000 plus installation costs
Weight: 15 metric tons
Availability: 2
Game Notes: *Space transports repair* rolls to install an Avatar-10 receive a +1D bonus.
Source: Galaxy Guide 6: Tramp Freighters (page 39)

x1 Hyperdrive

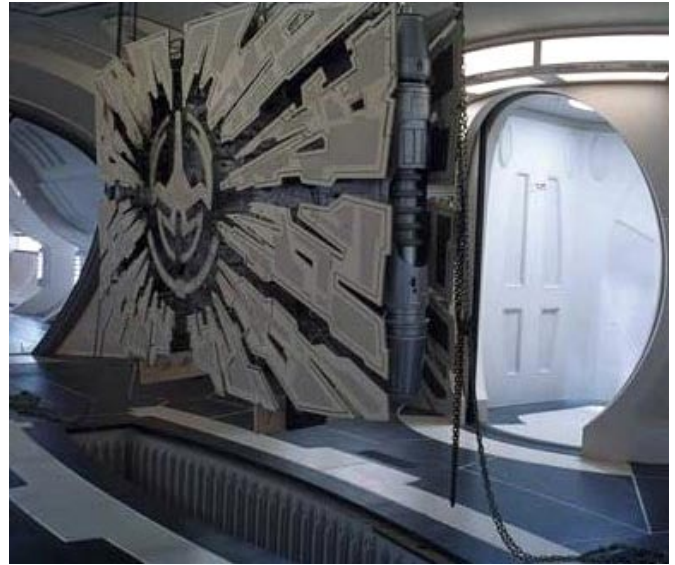

Model: SoroSuub Griffyn-XTG Lightspeed Unit
Type: Commercial hyperdrive
Cost: 15,000 plus installation costs
Weight: 18 metric tons
Availability: F
Game Notes: Any non-SoroSuub vessels attempting to install this type of drive suffer an increase of one difficulty level during the attempt.
Source: Galaxy Guide 6: Tramp Freighters (page 39)

Hyperdrive Booster

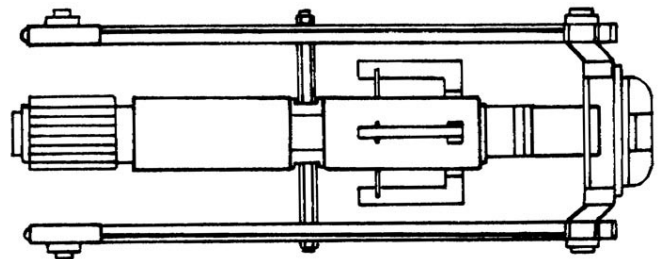

Model: HD 4-D Booster
Type: Hyperdrive booster
Skill: Space transports repair (to install)
Cost: 16,500+
Availability: 4, X
Game Notes: Reduces a ship's hyperdrive as noted below, but risks a severe system ship failure. Roll for a hyperdrive mishap as described on pages 34-36 of *Galaxy Guide 6: Tramp Freighters*, with a +2 mishap modifier. Works only on freighters with a 100 metric ton cargo capacity or less.

Current Hyperdrive Multiplier	New Hyperdrive Multiplier
x10+	x4
x9-x6	x3
x5-x3	x2
x2	x1
x1	x1/2

Source: Galladinium's Fantastic Technology (page 93)

Tools

Cargo Netting

Model: SoroSuub 1010 Cargo Restraint
Type: Cargo webbing
Cost: 100 per 10 by 10 meter section
Availability: 2
Game Notes: Cargo netting straps have 3D *Strength* for purposes of resisting damage.
Source: Platt's Smugglers Guide (page 53)

Loader's Gloves

Model: Vlanth LG70 Loader's Gloves
Type: Reinforced leader's gloves
Skill: Lifting or melee combat
Cost: 100 per pair
Availability: 1
Damage: STR+2
Game Notes: Gloves take five minutes to put on or take off, and you need a second non-gloved person to help you into the second glove. It's impossible to wield a blaster or perform any fine manipulation while wearing the protection gloves.
Source: Platt's Smugglers Guide (page 49)

Crate Hooks

Model: Vlanth Cargo Grippers
Type: Crate hooks
Skill: Lifting or melee combat
Cost: 50 per pair
Availability: 1
Damage: STR+1D
Game Notes: Although crate hooks make good melee weapons, they're too small and awkward to be used to parry attacks.
Source: Platt's Smugglers Guide (page 49)

Gear Bag

Model: SoroSuub Pak-It Gear Bag
Type: Gear bag
Cost: 50
Availability: 1
Source: Platt's Smugglers Guide (page 46)

Corrosion Preventative

Model: ColuChem Anti-Corr 113
Cost: 75 per liter
Availability: 2
Game Notes: Anti-Corr 113 stains everything it comes into contact with a pasty blue residue. Only expensive chemical solvents can remove the stains, sometimes causing physical damage to the treated item if composed of softer materials.
Source: Adventure Journal 9 (page 142)

Tech Scanner

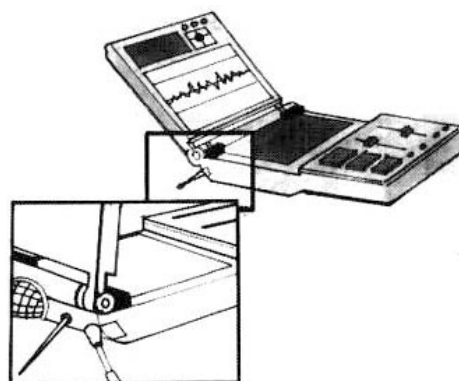

Model: Drever Corporation's Techaide
Type: Tech scanner
Cost: 2,600
Availability: 2
Game Notes: The difficulty level for using this scanner corresponds to the difficulty needed to repair damaged equipment. A character successfully using a tech scanner gains +1D on *repair* rolls.
Source: Gundark's Fantastic Technology (page 104)

Power Scanner

Model: Varge Corp. Energy Tester
Type: Power scanner
Cost: 150
Availability: 1
Game Notes: Bonuses for using a power scanner for repair work may range from +1 to +1D as decided by the gamemaster.
Source: Platt's Smugglers Guide (pages 57-58)

Starship Tool Kit

Model: SoroSuub Journeyman Tool Box
Type: Starship tool kit
Cost: 200
Availability: 1
Game Notes: This toolkit adds +1D to any starship-related repair rolls.
Source: Platt's Smugglers Guide (page 57)

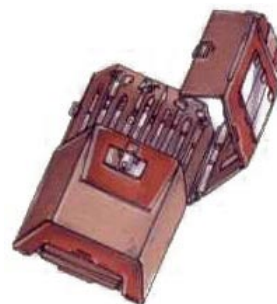

Tasari Mining Kit

Model: asCorp Essential Miner's Gear
Type: Utility kit for miners
Cost: 200
Availability: 3
Game Notes: A mining kit provides characters excavating tasar crystals with a +1D to their *search* or *mining* skill rolls
Source: Adventure Journal 15 (page 189)

Hydrospanner



Model: Corellian Engineering V-07 Hydrospanner
Type: Hydrospanner
Cost: 50
Availability: 1
Game Notes: Bonuses for using a hydrospanner for repair work may range from +1 to +1D as decided by the gamemaster.
Source: Platt's Smugglers Guide (page 57)

Servodriver

Model: Corellian Engineering SD-47
Type: Servodriver
Cost: 50
Availability: 1
Game Notes: Bonuses for using a servodriver for repair work may range from +1 to +1D as decided by the gamemaster.
Source: Platt's Smugglers Guide (page 57)

Laser Welder

Model: Borallis Metalworking & Materials LSW-983 Laser Welder

Type: Laser welder
Cost: 50
Availability: 1

Game Notes: Allows for welds from 0.2-20 centimeters in diameter. Bonuses for using a laser welder for repair work may range from +1 to +1D as decided by the gamemaster.

Source: Galladinium's Fantastic Technology (page 54), Platt's Smugglers Guide (page 58)

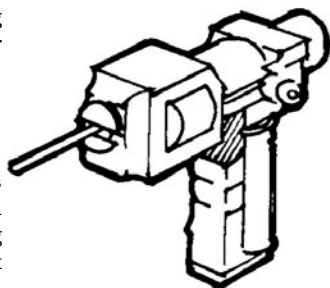

Power Prybar

Model: SoroSuub Prybar 2800

Type: Power prybar
Cost: 30
Availability: 1

Game Notes: When used to pry things up, open or apart, this tool adds +1D to +3D to the users *Strength*.

Source: Platt's Smugglers Guide (page 57)

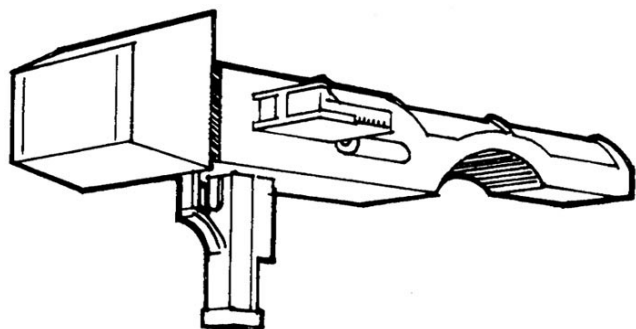

Squib Battering Ram

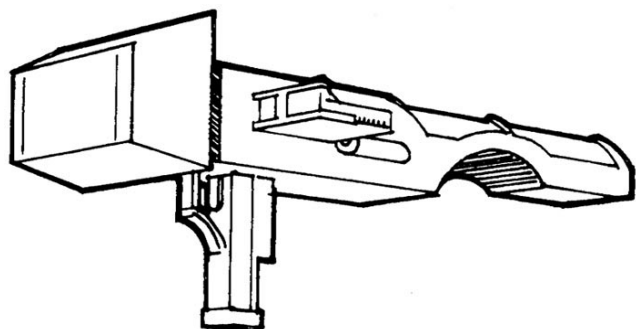

Model: Fegegrish Heavy Industrial Battering Ram

Type: Structural weakener

Skill: Demolitions

Cost: 3,500

Availability: 3

Game Notes: Device batters through solid obstacles, effectively doing 6D damage against the body of a wall or door.

Source: Galladinium's Fantastic Technology (page 57), Pirates & Privateers (page 48), Ultimate Alien Anthology (page 151)

Fusion Cutter

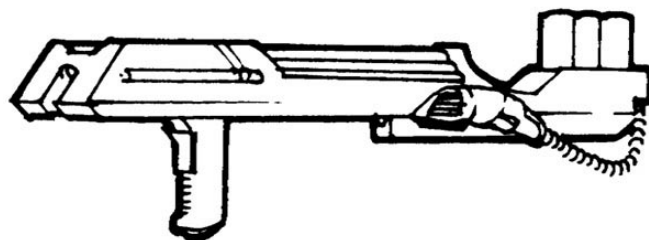

Model: Borallis Metalworkings & Materials PCW-876

Type: Fusion cutter

Skill: Various repair skills

Cost: 75

Availability: 1

Game Notes: Difficulty level when using this device is dependant on the project involved. Accidental exposure to beam causes 3D-6D damage. Bonuses for using a hydrospanner for repair work may range from +1 to +1D as decided by the gamemaster.

Source: Galladinium's Fantastic Technology (page 55), Pirates & Privateers (page 48), Platt's Smugglers Guide (page 58)

Heavy Fusion Cutter

Model: Borallis Metalworking & Materials PCW-880

Type: heavy fusion cutter

Skill: Assirted *Technical* skills

Cost: 150

Availability: 1

Damage: 3D

Game Notes: This unit is 1.2 meters long and uses a rechargeable power pack.

Source: Gundark's Fantastic Technology (page 98)

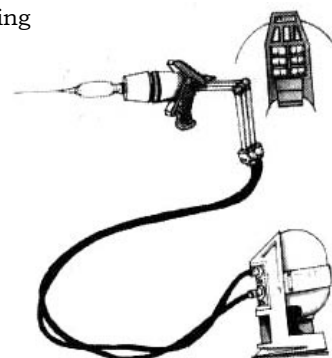

Portable Plasma Cutter

Type: Typical plasma cutter

Cost: 150 (gas canister: 20)

Availability: 1

Damage: 7D

Game Notes: It takes one round per 1D of body strength to cut a two-meter-by-one-meter hole. (For example: a blast door with 6D body strength would take six rounds.) When used as a weapon, the plasma cutter causes 7D physical damage; a Moderate *melee combat* roll is needed to hit. The blast goggles or blast visor must be used with the cutter;

anyone within two meters without proper eye protection must make a Moderate *Perception* roll to look away or be blinded for three minutes. (If someone is blinded, an attacker gets +10 to hit in combat.)

Source: Gundark's Fantastic Technology (page 99), Operation: Elrood (pages 86-87)

Plasma Punch



Model: Drever Corporation's Phoenix Plasma Punch

Type: Variable setting cutter

Scale: Starfighter

Cost: 5,000

Availability: 2, X

Damage: 6D

Game Notes: The Plasma Punch can be set to cut a circle from 3 centimeters to 3 meters in diameter. Given time, the Punch is able to cut through any material on the market, including quadranium and magnetically sealed hatches. It is very power consumptive, however; the unit can only be activated twice, for up to ten minutes each, before its batteries are drained. Recharges take 6 hours. The tool has a very limited range, 0-2 meters, and is impractical as a ship-to-ship weapon.

Source: Pirates & Privateers (page 48)

Miscellaneous

Plasma Torch Boarding Device

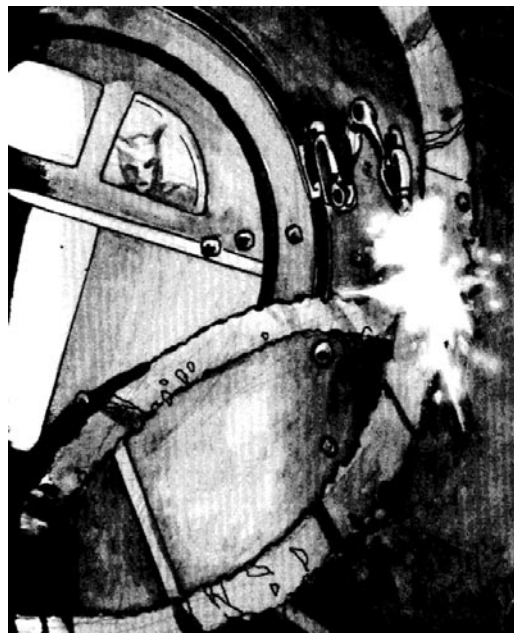

Model: BlasTech Plasma Cut Boarding Device

Type: Plasma torch boarding device

Scale: Starfighter

Skill: Starship gunnery

Crew: 2

Cost: 4,750

Availability: X

Game Notes: The plasma torch boarding device is mounted on a ship's airlock system. The controls are just inside the main airlock. The extendable plasma torch (fire control 0D, range of 4 meters, damage 8D) slowly cuts through a ship's hull. Roll the target ship's hull -2D; if the torch's roll scores "lightly damaged" result, it has breached the hull. Once the hull is breached, the torch requires a full minute to cut a one meter wide by two meter high hole. The extendable boarding tube attaches to the hull and forms an airtight seal in 30 second.

Source: Han Solo and the Corporate Sector Sourcebook (page 101), Pirates & Privateers (page 49)

Cotterdam Universal Airlock

Model: TaggCo. Cotterdam Universal Airlock

Type: Ship-to-ship airlock

Cost: 3,500

Availability: 2

Game Notes: One of the older and more proven universal spacelocks is a "cotterdam". This is a flexible tube with an interior ladder/walkway with a multi-lock ring on the extended end. The multi-lock ring houses three sets of pressure, chemical, magnetic, and mechanical surface-to-surface sealing methods.

Source: Pirates & Privateers (page 49)

Universal Airlock

Model: SoroSuub Corp. Universal Airlock

Type: Space-to-ship portable airlock

Cost: 3,000

Availability: 2

Game Notes: This airlock is made of a durable synthetic fabric over a geometrically collapsible frame. Collapsed, it is no longer than a half meter in diameter, but expands to a 5 meter diameter capsule with a hatch and bag-lock. The bag-lock exits to space, and is pressurized by a high power pneumatic pump. The other exit is a simple hatch, with a multi-lock sealing ring. The pressurized interior leaves the airlock somewhat vulnerable to punctures, although the frame resists instant depressurization – 3D *Strength* to resist damage.

Source: Pirates & Privateers (page 49)

Givin Emergency Vacuum Seal

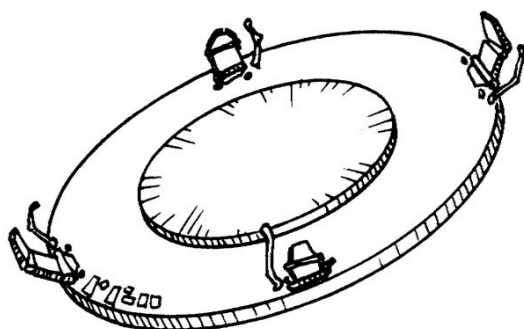

Model: Galvronos Givin Interchanges, Limited EVS BBS-909

Type: Emergency vacuum seal

Cost: 750 (up to 50 centimeters in diameter); 1,000 (51-100 centimeters in diameter)

Availability: 3

Game Notes: Normal application requires a Moderate *Strength* total (to fight the pull of the atmosphere rushing out into space) and a Moderate *Dexterity* total (to reach and hit the controls while the character is fighting not to get pulled out into space). Seals come in different sizes ranging from 10 centimeters to 1 meter in diameter.

Source: Galladinium's Fantastic Technology (page 66)

Personal Forcefield Generator

Model: meredex Atmospherics Personal Forcefield Generator

Type: Forcefield generator

Cost: 2,000

Availability: 4

Game Notes: This small device can be attached to a ship to seal small hull breaches by creating a forcefield up to two meters in diameter that protects a ship's life support system from a breach while in space.

Source: Ultimate Adversaries (page 156)

Deflector Shields

Model: Standard Deflector Shields

Type: Particle & ray/energy shields

Scale: Starfighter

Shield Code	Cost	Weight (in tons)
1D	4,000	6
2D	10,000	8
3D	20,000	10

Source: Galaxy Guide 6: Tramp Freighters (page 40)

Cargo-Mover Tractor Beam

Model: Bonadon Cargo-Mover Tractor Beam

Type: Light ship-to-ship tractor beam

Scale: Starfighter

Skill: Starship gunnery

Cost: 8,000

Weight: 15 metric tons

Availability: 2

Space Range: 1-3/7/15

Atmosphere Range: 100-300/700/1.5 km

Fire Control: 2D

Damage: 2D

Source: Pirates & Privateers (pages 46-47)

Tractor Beam

Model: Arakyd Flight Bay Tractor Beam

Type: Medium tractor beam

Scale: Starfighter

Skill: Starship gunnery

Crew: 1

Cost: 12,000

Availability: 2

Fire Control: 2D

Damage: 3D

Source: Hideouts & Strongholds (page 13)

Backup Battery

Model: Corellian Engineering Corp. Lifesaver Emergency Battery

Type: Backup battery

Cost: 10,000

Weight: 1 metric ton

Availability: 2

Game Notes: This backup battery is marketed as a life support system fail-safe, allowing up to an hour's extra survival in the event of a catastrophic power failure. Ordinarily, life support fails while running silent in only a few minutes, due to lack of power, but the backup battery allows the ship to lurk in space for an extended period.

Source: Pirates & Privateers (page 40)

Miscellaneous

Mystical Items

Kasha Meditation Crystal

Type: Meditation crystal

Cost: 2,000

Availability: 4

Game Notes: One hour of quiet, uninterrupted meditation with a kasha meditation crystal grants a Cerean a +3D *persuade* bonus for the next 24 hours. The character also gains a +1D inherent bonus on any single skill roll, provided the character has at least one pip allocated to that skill. Transforming an ordinary, unattuned kasha crystal into a meditative device requires an investment of 200 credits for raw materials, 72 hours of work and a Heroic *scholar: craft sculpture* roll.

Source: Ultimate Alien Anthology (page 31)

Life Crystal

Model: Life Crystal

Type: Alien technology

Cost: 5,000 credits per crystal (up to the Rise of the Empire); 25,000 credits (later eras, black market)

Availability: 3, R

Game Notes: After the first week of wearing a life crystal, roll 2D to determine its effects on the wearer:

Roll Result

2-3	+1 pips to <i>Strength</i>
4	+1 pips to <i>Perception</i>
5	+1 pips to <i>Knowledge</i>
6-8	No Effect
9	+1 pips to <i>Technical</i>
10	+1 pips to <i>Mechanical</i>
11-12	+1 pips to <i>Dexterity</i>

Each successive year, the wearer rolls again and can gain additional bonuses. The bonuses are cumulative, as are bonuses awarded by multiple life crystals. If a life crystal is not worn for 24 hours, the bonuses become penalties. If the crystal is replaced within a week, the bonuses are restored. If the crystal is not replaced, the penalties will wear off in one year.

Source: Gamer Magazine

Kaiburr Crystal

Type: Force-enhancing artifact

Cost: Not available for sale

Availability: 4

Game Notes:

Kaiburr crystal stores Force points, which can be used by a Force-user that takes possession of it. Each crystal stores five Force points, and these Force points can only be used to increase rolls made to employ Force powers. As long as the crystal is in close proximity to the Temple of Pomojema on Mimban, it regains 1 Force point every minute. If removed from Mimban, a crystal does not regain spent Force points, but can be used as a lightsaber crystal. Kaiburr crystals used in this way grant a +2 pip bonus to the lightsaber's damage, as well as a +2 pip bonus to all *lightsaber* skill rolls.

Source: Rebellion Era Sourcebook (page 84)



Void Stone

Type: Force-dampening artifact

Cost: Not available for sale

Availability: 4

Game Notes: All Force-users within 100 meters of the Void Stone suffer a -2D penalty to all Force skills. In addition, the use of Force points within the area of the Void Stone is reduced by half (ie, instead of doubling all dice pools, a Force point used near the Void Stone only grants a bonus of x1.5).

Source: Rebellion Era Sourcebook (page 85)

The Codex



Type: DarkStryder artifact

Scale: Character

Game Notes: The Codex is a small metallic pyramid that provides +2D to all Force skills that the user possesses. In addition, the Codex allows a Force-sensitive to automatically locate “galactic” scale disturbances in the Force (i.e. the destruction of a planet or other such cataclysm). Characters who attempt to use the device more than three round a day are subject to some penalties: any Dark Side points the character receives while using the Codex are doubled, and other Force-sensitives can locate the device fairly easily, often over distances of more than 100 light years. The Codex has a body strength of 1D to resist damage. If the device is roughly handled or otherwise damaged, it will break and cannot be repaired.

Source: The DarkStryder Campaign – The Kathol Rift (page 62)

The Bracers of Najus



Type: Dark side artifact

Scale: Character

Cost: Not available for sale

Availability: Unique

Game Notes: If worn, the Bracers of Najus double the benefits of any attempts to call upon the Dark Side against a target who is allied with the light side of the Force (ie, against a Force-sensitive opponent who has no Dark Side points). What this means is that any Force points gained by calling on the Dark Side triple the character’s dice pools instead of doubling them. The bracers have no effect if the user’s opponent has at least one Dark Side point. In fact, the Dark Side-allied opponent gains any beneficial bonuses if an attempt is made to use the bracers against him.

Source: Gamer Magazine

Sith Translation Talisman



Type: Sith talisman

Cost: Not available for sale

Availability: 4

Game Notes: This talisman allows the wielder to read the Sith’s ancient language as if it were his own native tongue.

Source: Tales of the Jedi Companion (page 82)

Sith Force Mask Talisman

Type: Sith talisman

Cost: Not available for sale

Availability: 4

Game Notes: Force-wielding characters using the *sense* skill to detect disturbances in the Force cannot perceive

any Force use by the holder of a Force mask.

Source: Tales of the Jedi Companion (page 81)

Sith Concentration Talisman

Type: Sith talisman

Skill: Control, sense or alter

Cost: Not available for sale

Availability: 4

Game Notes: Force-user must touch the talisman throughout the Force power’s initiation. It grants a 1D, 2D, or 3D bonus to any one Force skill. Affected skill may be changed between uses of Force powers, but not during the initiation of one power that requires more than one Force skill. The amount of bonus is dependant on the particular

taliman; weaker ones are more common, while the more powerful ones are extremely rare.

Source: Tales of the Jedi Companion (page 80)

Sith Shield Talisman

Type: Sith talisman

Cost: Not available for sale

Availability: 4

Game Notes: The shield talisman confers a bonus of up to 3D (there are 1D, 2D, and 3D versions of the device) against energy and Force attacks directed at the wielder. The number of absorbed dice directly correlates to the rarity of the item.

Source: Tales of the Jedi Companion (pages 81-82), The Dark Side Sourcebook (page 67)

Sith Healing Talisman

Type: Sith talisman

Skill: Control, sense or alter

Cost: Not available for sale

Availability: 4

Game Notes: A Force-user may heal one being by one wound level for each die of Force skill (*control, sense or alter*)

he wishes to give up for the following ten hours.

Source: Tales of the Jedi Companion (page 81)

Sith Ensnarement Talisman

Type: Sith talisman

Skill: Control, sense or alter

Cost: Not available for sale

Availability: 4

Game Notes: Force-user must touch the talisman throughout the Force power's initiation. It grants a 1D, 2D, or 3D bonus to any one Force skill. Affected skill may be changed between uses of Force powers, but not during the initiation of one power that requires more than one Force skill. The amount of bonus is dependant on the particular taliman; weaker ones are more common, while the more powerful ones are extremely rare. Each time a light sider uses the device he must make a *willpower* or *control* roll against an ever-increasing difficulty. The first use requires a Very Easy roll, the second an Easy roll, the third a Moderate



roll, and so forth. Failing the roll means that the user automatically turns to the dark side.

Source: Tales of the Jedi Companion (page 81)

Sith Abattar

Type: Sith talisman

Skill: Alter

Cost: Not available for sale

Availability: 4

Game Notes: This amulet consists of a thin silver chain adorned with six dagger-shaped wedges that's inexplicably heavy. Force-users who don the abattar find themselves able to speak and understand any language, though the strain of the experience deals 2D damage per minute. Force-users with the Alter Force skill can focus the amulet's energy into a destructive blast. Blast attack is rolled with the Alter skill, has a range of 2-5/10/20 and deals Alter+2D damage. Firing the blast deals a wound on the user and gives a Dark Side Point.

Source: Geonosis and the Outer Rim Worlds (pages 32-33)

Sith Sarcophagus



Type: Sith sarcophagus

Cost: Not available for sale

Availability: 4

Game Notes: If the Dark Side spirit is within ten meters of its Sarcophagus, Force-sensitive characters within ten meters must make Moderate *control* or *willpower* rolls or succumb to feelings of anger, fear, and aggression. If a character who has failed this roll attempts to call on the Force at any time within 24 hours, he will automatically call on the Dark Side. If any character finds himself laying inside a Sith sarcophagus for more than a single full round, he must make a Moderate *willpower* roll or be possessed by the Dark Side spirit. Transferring the essence of a living being into a Sith sarcophagus requires that one be custom built. The being creating the sarcophagus must have the Alchemy Force power and another living being to sacrifice. To complete the process, the Force user must successfully use the Transfer Life Force power. For every 100 lives that are willingly sacrificed, the difficulties on the use of the Transfer Life power are reduced by 1.

Source: Gamer Magazine

Entertainment

Coruscant Cascader

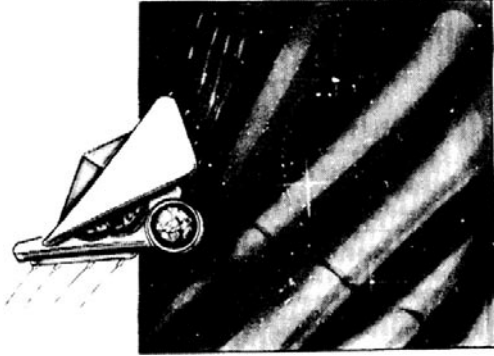

Model: Farbreini MicroElectronics Limited Coruscant Crusader BPEA-1A

Type: Electronic molecular excitation net

Cost: 5,000

Availability: 4

Game Notes: Creates a dazzling matrix of custom-designed light shapes that highlight the wearer.

Source: Galladinium's Fantastic Technology (page 34)

Aqualish Bio-Light Panel



Model: Ferisoliq Imports, Ltd. ABP-980

Type: Aqualish bio-light panel

Cost: 250

Availability: 2

Game Notes: Emmits light in an ever-changing array of fluid, picturesque patterns.

Source: Galladinium's Fantastic Technology (page 28)

Synth-Harmonica

Model: Mikar Music Ampified Synth-Harmonica

Type: Musical instrument

Scale: Character

Skill: Musical instrument operation: synth-harmonica

Cost: 500

Availability: 2

Source: Gundark's Fantastic Technology (page 86)

Kloo Horn



Model: Gonidor Supply Co. Hand-made Kloo Horn

Type: Custom-made Bith musical instrument

Scale: Character

Skill: Musical instrument operation: Kloo Horn

Cost: 2,000

Availability: 3

Source: Gundark's Fantastic Technology (pages 85-86), Ultimate Alien Anthology (page 24)

Chidinkalu

Model: Gonidor Supply Co. Hand-made Chidinkalu

Type: Custom-made Bith musical instrument

Scale: Character

Skill: Musical instrument operation: chidinkalu

Cost: 2,500

Availability: 3

Source: Gundark's Fantastic Technology (page 85), Ultimate Alien Anthology (page 89)

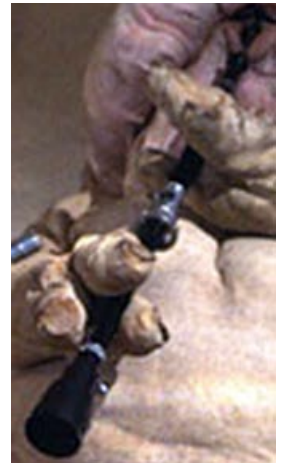

Spheroids Globe

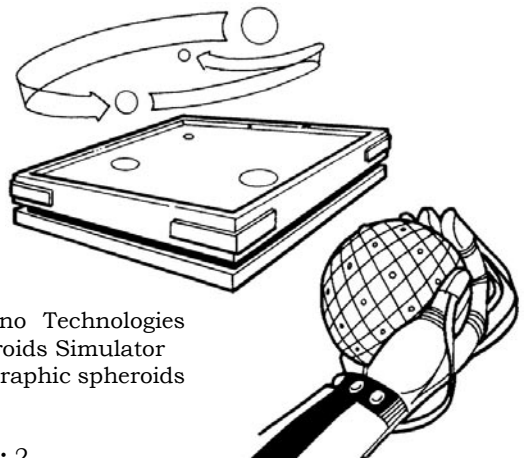

Model: Sarno Technologies

Home Spheroids Simulator

Type: Holographic spheroids simulator

Cost: 500

Availability: 2

Game Notes: Different game maneuvers are accomplished with various *thrown weapons* totals. The gamemaster may set target difficulties or have opponents make opposed rolls to see who wins a given contest.

Source: Galladinium's Fantastic Technology (pages 48-49)

Declination Mental Combat Game

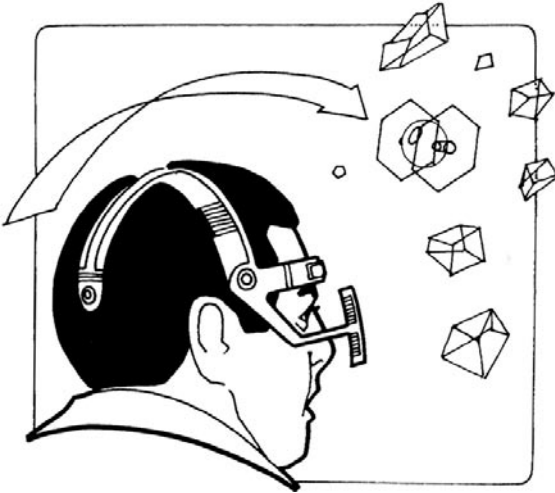

Model: Wethrenn Amusements, Unlimited Declination Holographic Game

Type: Mental holographic game

Cost: 3,500

Availability: 3

Game Notes: Characters may use either *starfighter piloting* and *starship gunnery* or *Perception* to play. Difficulties for navigating the asteroid field can range from Very Easy to Heroic (+10, +20, or more). Actual combat rolls are opposed skill rolls, with additional modifiers based on the difficulty of the terrain.

Source: Galladinium's Fantastic Technology (page 49)

Holomatic Dejarik Set

Model: Lakan Industries DHS-2

Type: Holographic dejarik system

Skill: Scholar: dejarik (a *Knowledge* skill)

Cost: 1,500, 100 (additional data modules)

Availability: 2

Source: Galladinium's Fantastic Technology (page 51)



B'shingh

Model: Dekerno Inc. B'shingh Holo Game

Type: Entertainment game

Scale: Character

Skill: Alien species, tactics

Cost: 500

Availability: 3

Game Notes: Intellectual military game.

Source: Gundark's Fantastic Technology (page 85)

Imperial Command Combat Simulator

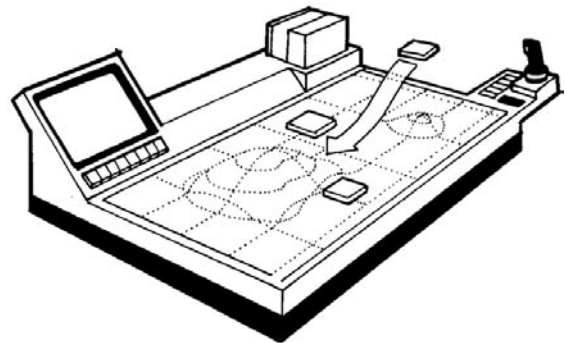

Model: Plescinea Entertainments CS-Mark 10

Type: Computerized holographic combat simulator

Skill: Tactics

Cost: 350

Availability: 2

Game Notes: In addition to the 12 "stock" historical simulations built into this unit, a "scenario editor" feature allows the user to custom create additional historical or hypothetical engagements. And Easy *computer programming/repair* roll is required to install the system. Games scenarios require various *tactics* rolls (difficulty varies by scenario).

Source: Galladinium's Fantastic Technology (page 51)

Household

Universal Power Adaptor

Model: Udrane Galactic Electronics Universal Power Adaptor

Type: Universal power adaptor

Cost: 100

Availability: 2

Game Notes: The term "universal" is not 100 percent correct: the user is required to make a Very Easy *Technical* roll to make the proper adjustments for the adaptor.

Source: Galladinium's Fantastic Technology (page 33)

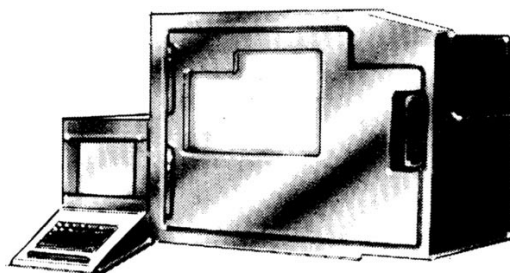
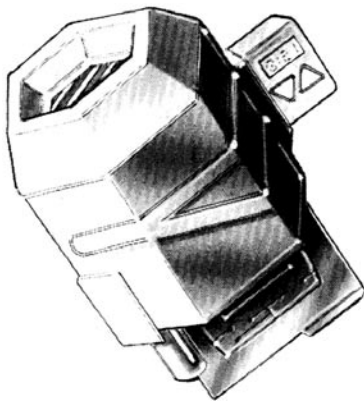

care of the entire food preparation process.

Source: Galladinium's Fantastic Technology (page 30)

Dispersion Canister

Model: Valkrex Machinery Dispersion Canister

Type: Personal waste disintegrator

Cost: 400

Availability: 2

Game Notes: Canister is a round cylinder, 1 meter tall by 40 centimeters in diameter. Each canister contains 6 removable and rechargeable power packs, which are charged with the energy of disintegrated waste.

Source: Galladinium's Fantastic Technology (page 30)

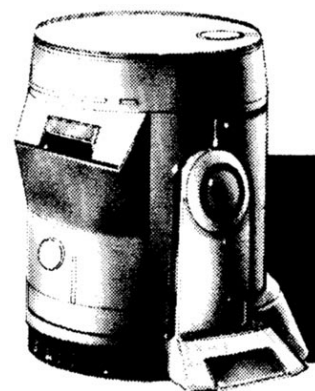

Cold Crate

Model: SoroSuub CLD-50 Cryo-Case

Type: Cold crate

Cost: 250 (50 per additional cryo canister)

Availability: 2

Game Notes: The unit has enough power and liquid gas to keep the crate at or below freezing for 50 standard hours. Low temperatures can be maintained indefinitely by recharging the fuel cells from a generator and replacing the cryo canister with a spare.

Source: Platt's Smugglers Guide (page 52)

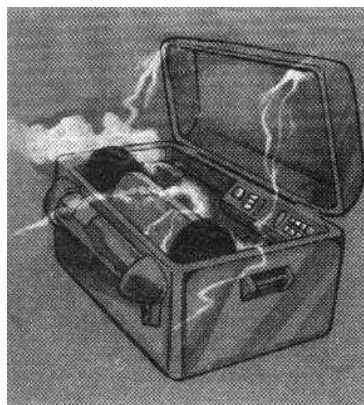

Refresher Booth

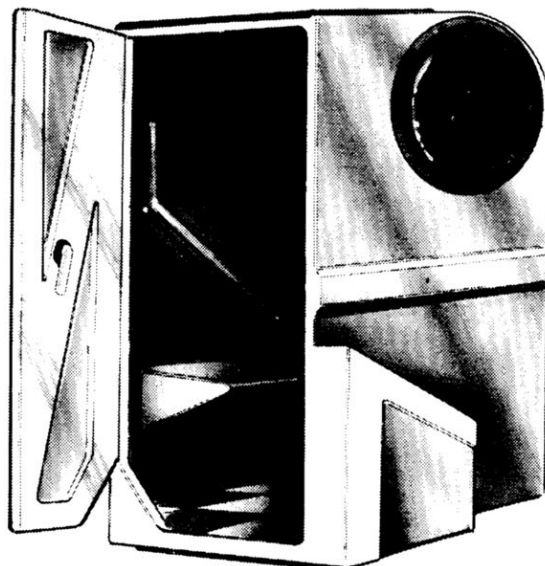

Model: zZip Products Concepts Ltd. Refresher Booth

Type: Personal hygienic refreshment system

Cost: 2,500

Availability: 2

Game Notes: Fully automated and self-contained ultrasonic shower system.

Source: Galladinium's Fantastic Technology (page 30)

Hot Box

Model: SoroSuub HT-50 Heated Crate

Type: Hot box

Cost: 250

Availability: 2

Game Notes: The power cells can keep the inside hot for up to 50 hours; it's easily recharged from a generator.

Source: Platt's Smugglers Guide (page 52)

Food Manager

Model: Synergistics Rapid Recipe Food Management System

Type: Automated food preparation unit

Skill: Culinary arts (Knowledge skill)

Cost: 250

Availability: 2

Game Notes: A Very Easy *culinary arts* roll is required to locate a specific recipe from the unit's database. A Moderate (9 or higher) roll is necessary to incorporate a new recipe from scratch. Just add the ingredients and the system takes

Repulsor Lounge Floater

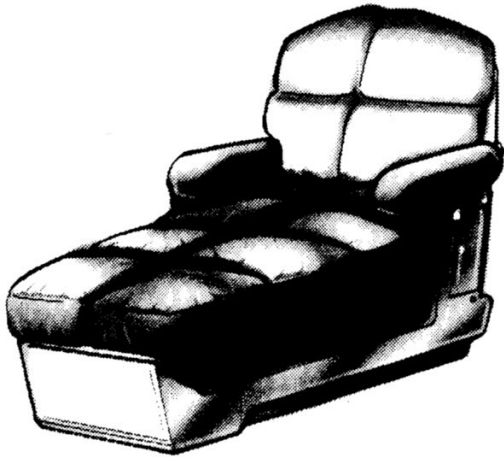

Model: Gaffaden Lounger 432GLM

Type: Repulsor lounge floater

Cost: 350

Availability: 2

Game Notes: Features adjustable repulsor field from one to 30 centimeters and micro-inducers for a relaxing massage.

Source: Galladinium's Fantastic Technology (page 31)

Sun Room

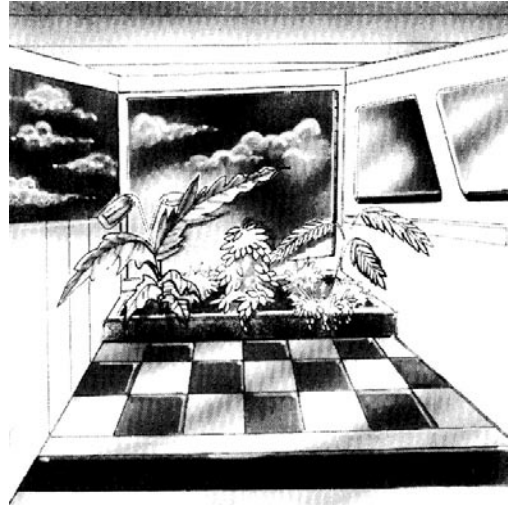

Model: zZip Product Concepts Limited, Deluxe Sun Room

Type: Artificial environment booth

Cost: 22,500

Availability: 3

Game Notes: Unit is 20 square meters and 3 meters tall. Simulates natural lighting, temperature and radiation conditions on any number of worlds.

Source: Galladinium's Fantastic Technology (page 32)

The Rebel Alliance is too well equipped. They're more dangerous than you realize.



EQUIPMENT
STATS
INCLUDES:



www.westendgames.com



www.starwars.com

©2001 Lucasfilm Ltd. & ® or TM where indicated. All rights reserved. Used under authorization.

ISBN 0-7869-2663-5



9 780786 926633

U.S. \$26.95 CAN \$37.95
Printed in Brasil WEG 1138

EAN

system